

FLORIDA STORMWATER EROSION AND SEDIMENTATION CONTROL INSPECTOR'S MANUAL

**Florida Department of Environmental Protection
Nonpoint Source Management Section
Tallahassee, Florida**

July 2008

This publication was funded in part by the Florida Department of Environmental Protection with a Section 319 Nonpoint Source Management Program Grant from U.S. Environmental Protection Agency.

CONTENTS

LIST OF ACRONYMS AND ABBREVIATIONS	IX
INTRODUCTION.....	XI
Purpose and Contents	xi
CHAPTER 1: EROSION AND SEDIMENTATION	1
1.1 The Erosion Process	1
1.2 Types of Water Erosion	2
1.3 Factors Influencing Erosion	2
1.4 Impacts of Erosion and Sedimentation	4
1.5 Erosion and Sediment Hazards Associated with Land Development	5
1.6 Principles of Erosion and Sediment Control	6
CHAPTER 2: SOILS	9
2.1 Introduction to Soils	9
2.2 Soil Classification and Properties	10
2.3 Soil Surveys	15
CHAPTER 3: REGULATIONS AND STATUTORY REQUIREMENTS	17
3.1 Introduction	17
3.2 NPDES Stormwater Permitting Regulations and Statutory Requirements	19
3.3 Construction Stormwater Pollution Prevention Plan Template	25
CHAPTER 4: BEST MANAGEMENT PRACTICES FOR EROSION AND SEDIMENTATION CONTROL.....	33
4.1 Construction Sequencing	33
4.2 Pollution Source Controls on Construction Sites	36
4.3 Stabilized Construction Exit	39
4.4 Perimeter Controls	44
4.5 Storm Drain Inlet Protection	75
4.6 Temporary Sediment Trap	95
CHAPTER 5: BEST MANAGEMENT PRACTICES FOR DEWATERING OPERATIONS	125
5.1 Introduction	125
5.2 Limitations	127
5.3 Implementation	127
5.4 Inspection and Maintenance	128

CHAPTER 6: BEST MANAGEMENT PRACTICES FOR STORMWATER MANAGEMENT	147
6.1 Introduction	147
6.2 Earthwork Specifications	149
6.3 Stormwater Retention Basin	150
6.4 Exfiltration Trench	153
6.5 Porous Pavement	163
6.6 Concrete Grid and Modular Pavement	165
6.7 Stormwater Detention Basin	167
6.8 Underdrain and Filtration Systems	171
6.9 Swales	177
6.10 Stormwater Conveyance Channel	182
6.11 Paved Flume	186
6.12 Diversion	188
6.13 Check Dam	192
6.14 Outlet Protection	194
6.15 Riprap	199
6.16 Grid Confinement System	203
6.17 Cellular Concrete Block	206
6.18 Maintenance	211
CHAPTER 7: BEST MANAGEMENT PRACTICES—VEGETATION FOR EROSION CONTROL	221
7.1 Introduction	221
7.2 Surface Roughening	221
7.3 Topsoiling	227
7.4 Temporary Seeding	229
7.5 Permanent Seeding	231
7.6 Sodding	235
7.7 Mulching	241
7.9 Tree Preservation and Protection	263
7.10 Vegetative Streambank Stabilization	271
CHAPTER 8: THE EROSION AND SEDIMENT CONTROL PLAN.....	279
8.1 Introduction	279
8.2 Elements of the Erosion and Sediment Control Plan	279
8.3 Implementing the Erosion and Sediment Control Plan	281

CHAPTER 9: INSPECTION AND ENFORCEMENT.....	285
9.1 Introduction	285
9.2 The Role of the Inspector	285
9.3 Site Inspection	287
9.4 Regulatory Agencies	295
REFERENCES.....	315

LIST OF TABLES

<i>Table 2.1. USDA Particle Size Classes</i>	<i>11</i>
<i>Table 2.2. USDA Soil Permeability Classes</i>	<i>13</i>
<i>Table 4.1. Size of Slope Drain</i>	<i>61</i>
<i>Table 4.2. Minimum Top Width (W) and Outlet Height (Ho) Required for Sediment Trap Embankment According to Height of Embankment (feet)</i>	<i>96</i>
<i>Table 4.3. Minimum Pipe Diameter for Pipe Outlet Sediment Trap According to Maximum Size of Drainage Area</i>	<i>97</i>
<i>Table 5.1. Comparison of Dewatering Technologies</i>	<i>126</i>
<i>Table 6.1. Grass Establishment Alternatives</i>	<i>180</i>
<i>Table 7.1. Organic Mulch Materials and Application Rates</i>	<i>242</i>
<i>Table 7.2. Conditions Where Vegetative Streambank Stabilization Is Acceptable</i>	<i>274</i>

LIST OF FIGURES

<i>Figure 2.2. Guide to the Textural Classification of Soils</i>	<i>11</i>
<i>Figure 4.3a. Temporary Gravel Construction Entrance</i>	<i>41</i>
<i>Figure 4.3b. Soil Tracking Prevention Device</i>	<i>42</i>
<i>Figure 4.3c. Construction Entrance with Wash Rack</i>	<i>43</i>
<i>Figure 4.4a. Silt Fence</i>	<i>47</i>
<i>Figure 4.4b. Installing a Filter Fabric Silt Fence</i>	<i>48</i>
<i>Figure 4.4c. Double Row Staked Silt Fence</i>	<i>50</i>
<i>Figure 4.4d. Proper Placement of a Silt Fence at the Toe of a Slope</i>	<i>50</i>
<i>Figure 4.4e. Temporary Diversion Berm</i>	<i>55</i>
<i>Figure 4.4f. Temporary Fill Diversion</i>	<i>57</i>
<i>Figure 4.4g. Overside Drain</i>	<i>60</i>
<i>Figure 4.4h. Flared End Section Schematic</i>	<i>61</i>
<i>Figure 4.4i. Flared End Section Specifications</i>	<i>62</i>
<i>Figure 4.4j. Temporary Slope Drain</i>	<i>64</i>
<i>Figure 4.4k. Slope Drain</i>	<i>65</i>
<i>Figure 4.4l. Type I and II Floating Turbidity Barriers</i>	<i>70</i>

Figure 4.4m.	Type III Floating Turbidity Barrier	71
Figure 4.4n.	Typical Installation Layouts	72
Figure 4.5a.	Silt Fence Drop Inlet Sediment Barrier	77
Figure 4.5b.	Filter Fabric Drop Inlet Sediment Filter	78
Figure 4.5c.	Gravel and Wire Mesh Drop Inlet Sediment Filter	80
Figure 4.5d.	Block and Gravel Drop Inlet Sediment Filter	81
Figure 4.5e.	Gravel Filters for Area Inlets	84
Figure 4.5f.	Sod Drop Inlet Sediment Filter	85
Figure 4.5g.	Gravel Curb Inlet Sediment Filter	87
Figure 4.5h.	Gravel Curb Inlet Sediment Filter with Overflow Weir	88
Figure 4.5i.	Block and Gravel Curb Inlet Sediment Barrier	89
Figure 4.5j.	Curb Inlet Gravel Filters	90
Figure 4.5k.	Curb Inlet Sediment Barrier	92
Figure 4.5l.	Gravel Bag Curb Sediment Filters	93
Figure 4.5m.	Curb and Gutter Sediment Barrier	94
Figure 4.6a.	Earth Outlet Sediment Trap	98
Figure 4.6b.	Pipe Outlet Sediment Trap	99
Figure 4.6c.	Stone Outlet Sediment Trap	101
Figure 4.6e.	Excavated Drop Inlet Sediment Trap	102
Figure 4.6f.	Storm Inlet Sediment Trap	103
Figure 4.6g.	Small Sediment Trap Located in a Stormwater Conveyance Channel	104
Figure 4.6h.	Sediment Containment Filter Bag	105
Figure 4.7a.	Sediment Basin Storage Volumes	107
Figure 4.7b.	Sample Plan View of Baffle Locations in Sediment Basins	108
Figure 4.7c.	Sediment Basin Schematic Elevations	110
Figure 4.7d.	Antivortex Device Design	112
Figure 4.7e.	Riser Pipe Conditions	113
Figure 4.7f.	Location of Anti-seep Collars	114
Figure 4.7g.	Emergency Spillway	114
Figure 4.7h.	Sediment Basin	115
Figure 4.8a.	Rock Check Dam	121
Figure 4.8b.	Rock Check Dam Details	122
Figure 5.4.	Dewatering Operations Flow Chart	129
Figure 6.3a.	Off-Line Treatment Systems	151
Figure 6.3b.	Schematic of Flow Characteristics Associated with Infiltration from Retention Ponds during Low and High Water Table Conditions	152
Figure 6.4a.	Cross-Section of Typical Infiltration/Exfiltration System for Parking or Roads	154
Figure 6.4b.	Sample Application of a Vegetated Area for Pretreatment of Runoff Prior to Exfiltration in Frederick County, Maryland	155

Figure 6.4c.	Examples of Typical Underground Percolation Systems for Retrofitting Existing Storm Sewer Systems in Orlando, Florida	159
Figure 6.4d.	Detailed Schematic of a Typical Observation Well	161
Figure 6.5.	Examples of Porous Pavement Drainage Systems	164
Figure 6.6.	Types of Grid and Modular Pavement	166
Figure 6.7a.	Typical Detention Basin Hydrographs	168
Figure 6.7b.	Examples of Dead Storage Areas in Wet Ponds	169
Figure 6.7c.	Wet Detention System, Pond Configuration – A	170
Figure 6.7d.	Wet Detention System, Pond Configuration – B	170
Figure 6.8a.	Cross-Section of Stormwater Discharge Structure with "Mixed Media" Bank Filter System	172
Figure 6.8b.	Illustration of Typical "Natural Soil" Bank Filtration System with Box Inlet Drop Spillway and "V" Notched Weir (Wet Detention Facility)	173
Figure 6.8c.	Typical Subdivision Layout Showing On-Line Detention Pond and Outfall	174
Figure 6.8d.	Typical Subdivision Layout Showing Off-Line Detention Pond and Outfall	175
Figure 6.8e.	Typical Cross-Section of Elevated Sand Filter for Stormwater Treatment Used in Conjunction with Dry Detention Facility	176
Figure 6.9a.	Typical Swale Block Cross-Section	178
Figure 6.9b.	Typical Waterway Shapes and Mathematical Expressions for Calculating Cross-Sectional Area, Top Width, and Hydraulic Radius	179
Figure 6.10a.	Typical Waterway Cross-Sections	184
Figure 6.10b.	Typical Stone-Lined Waterways	185
Figure 6.11.	Paved Flume	187
Figure 6.12.	Types of Diversions	190
Figure 6.13.	Spacing Between Check Dams	193
Figure 6.14a.	Energy Dissipator	195
Figure 6.14b.	Energy Dissipator	196
Figure 6.14c.	Pipe Outlet Conditions	197
Figure 6.14d.	Paved Channel Outlet	198
Figure 6.15a.	Rock-Lined Channel	200
Figure 6.15b.	Riprap Slope Protection	201
Figure 6.15c.	Toe Requirements for Bank Stabilization	202
Figure 6.16a.	Grid Confinement System	203
Figure 6.16b.	Vegetative Protection	204
Figure 6.16c.	Gravity Retaining Wall	204
Figure 6.17a.	Slope Protection	207
Figure 6.17b.	Channel Bottom Protection	207
Figure 6.17c.	Grout Illustration	210
Figure 6.17d.	Revegetation	210
Figure 7.2a.	Stair-Stepped Slope	223

Figure 7.2b.	<i>Grooved or Serrated Slope</i>	224
Figure 7.2c.	<i>Terraced Slope</i>	225
Figure 7.2d.	<i>Roughening with Tracked Machinery</i>	226
Figure 7.6a.	<i>Sodding</i>	236
Figure 7.6b.	<i>Sodding Swales and Waterways</i>	238
Figure 7.7a.	<i>Typical Orientation of Treatment 1 – Soil Stabilization Blanket</i>	244
Figure 7.7b.	<i>Typical Treatment 1 – Soil Stabilization Blanket Installation Guide</i>	246
Figure 7.7c.	<i>Erosion Blankets and Turf Reinforcement Mats – Slope Installation</i>	247
Figure 7.7d.	<i>Typical Treatment 2 – Soil Stabilization Matting Slope Installation</i>	248
Figure 7.7e.	<i>Erosion Blankets and Turf Reinforcement Mats – Channel Installation</i>	249
Figure 7.7f.	<i>Typical Treatment 2 – Soil Stabilization Matting Installation</i>	250
Figure 7.7g.	<i>Stakes, Staples, and Pins for the Installation of Soil Stabilization Matting</i>	252
Figure 7.7h.	<i>General Staple Pattern Guide and Recommendation for Treatment 2 – Soil Stabilization Matting</i>	253
Figure 7.8a.	<i>Benefits of Trees</i>	255
Figure 7.8b.	<i>Planting Bare Root Seedlings</i>	256
Figure 7.8c.	<i>Planting Balled-and-Burlapped and Container-Grown Trees</i>	257
Figure 7.8d.	<i>Spacing Trees for Safety and Effective Landscaping</i>	259
Figure 7.9a.	<i>Determining the CRZ and TCA</i>	264
Figure 7.9b.	<i>Tree Conservation Area Protection Practices</i>	266
Figure 7.9c.	<i>Trenching vs. Tunneling</i>	268
Figure 7.9d.	<i>Proper Pruning Technique</i>	270
Figure 7.10a.	<i>Typical Annual Curve of Water Levels Correlated with Typical Vegetative Zones</i>	273
Figure 7.10b.	<i>Straw Wattles</i>	276

LIST OF ACRONYMS AND ABBREVIATIONS

AASHTO	American Association of State Highway and Transportation Officials
ANSI	American National Standards Institute
ASCE	American Society of Civil Engineers
BMP	Best management practice
BOD	Biochemical oxygen demand
cfs	Cubic feet per second
CGP	Generic Permit for Stormwater Discharge from Large and Small Construction Activities
CWA	Clean Water Act
cm	Centimeter
cm ²	Square centimeter
CRZ	Critical root zone
DBH	Diameter breast height
DH&T	Department of Highways and Transportation
DOT	Department of Transportation
DSWC	Division of Soil and Water Conservation
EOS	Equivalent opening size
EP	Extraction Procedure
EPA	U.S. Environmental Protection Agency
ERP	Environmental Resource Permit
F.A.C.	Florida Administrative Code
FDEP	Florida Department of Environmental Protection
FDOT	Florida Department of Transportation
F.S.	Florida Statutes
ft ²	Square foot
ft ³	Cubic foot
g	Gram
GIS	Geographic information system
gpm	Gallons per minute
H	Height
Ha	Hectare
HDPE	high-density polyethylene
Ho	Outlet height
IECA	International Erosion Control Association
IFAS	Institute of Food and Agricultural Sciences
LOD	Limits of disturbance
kg	Kilogram
km	Kilometer
km ²	Square kilometer
lb	Pound
m	Meter
m ³	Cubic meter
mm	Millimeter
MS4	Municipal separate storm sewer system
NOEC	No observed effects concentration
NOI	Notice of Intent
NOT	Notice of Termination
NPDES	National Pollutant Discharge Elimination System
NRCS	Natural Resources Conservation Service
NTU	Nephelometric turbidity unit
OSHA	Occupational Safety and Health Administration
PAM	Polyacrylamide

LIST OF ACRONYMS AND ABBREVIATIONS

PVC	Polyvinyl chloride
sec	Second
SU	Standard unit
SWCC	Soil and Water Conservation Commission
SWFWMD	Southwest Florida Water Management District
SWPPP	Stormwater pollution prevention plan
T	Tonne
TCA	Tree conservation area
TSS	Total suspended solids
UCF	University of Central Florida
USACOE	U.S. Army Corps of Engineers
USDA	U.S. Department of Agriculture
USGS	U.S. Geological Survey
USLE	Universal Soil Loss Equation
UV	Ultraviolet
W	Width
WET	Whole Effluent Toxicity
yr	Year

INTRODUCTION

- **Purpose and Contents**

* * * * *

Purpose and Contents

On average, Florida receives 40 to 60 inches of rain each year from about 130 storm events. While about 80% of the storms are small, with less than 1 inch of rainfall, the state also experiences torrential downpours and hurricane rains. These cause runoff carrying sediment, fertilizers, pesticides, oil, heavy metals, bacteria, and other contaminants to enter surface waters, causing adverse effects from increased pollution and sedimentation. The implementation of erosion control measures consistent with sound agricultural and construction operations is essential to minimizing these impacts.

Florida's stormwater regulatory program requires the use of best management practices (BMPs) during and after construction to minimize erosion and sedimentation and to properly manage runoff for both stormwater quantity and quality. BMPs are control practices that are used for a given set of conditions to achieve satisfactory water quality and quantity enhancement at a minimal cost. Each BMP has specific application, installation, and maintenance requirements that should be followed to control erosion and sedimentation effectively. Accepted engineering methods must be used in the design of these control measures, such as those established by the Florida Department of Environmental Protection (FDEP), Florida Department of Transportation (FDOT), U.S. Department of Agriculture's (USDA) Natural Resources Conservation Service (NRCS), International Erosion Control Association (IECA), American Society of Civil Engineers (ASCE), U.S. Army Corps of Engineers (USACOE), or other recognized organizations.

Insufficient staffing among regulatory agencies, combined with a lack of awareness among contractors, historically resulted in a low rate of compliance for implementing these BMPs. In an effort to address the problem, in 1999 FDEP developed a training and certification program on their use, installation, and maintenance. While the program is primarily directed towards inspectors and contractors, permit reviewers and public works staff will also benefit. The program's objectives are as follows:

- *To ensure that the desired benefits of stormwater management systems are being achieved.*
- *To ensure that both the public and private sectors have enough inspectors trained in the proper installation and maintenance of BMPs during and after construction.*
- *To ensure a consistent level of technical expertise and professional conduct for all individuals responsible for inspecting erosion and sediment controls and stormwater management systems.*

This updated version of the *Florida Stormwater, Erosion, and Sedimentation Control Inspector's Manual* is an important element of FDEP's training and certification program. It provides a "toolbox" of BMPs with instructions for their use and is designed to be a comprehensive reference source for the conduct of your daily professional duties. Do not attempt to memorize the entire manual. Instead, become familiar enough with it so that you know where to find information quickly. Review the manual periodically to improve and maintain your technical and personal skills. Refer to it when facing a new situation or when in doubt. Try to keep the manual with you while conducting your duties.

Always remember that the rules are performance based—i.e., the measures used at a construction site must effectively control erosion and prevent sedimentation from reaching a regulated receiving water for the site to be in compliance. The implementation of BMPs according to this manual is no guarantee of success, nor is it a constraint to prevent the use of other more efficient or cost-effective measures.¹

Chapters 1 and 2 of the manual provide essential information on the erosion and sedimentation process, soil classification and properties, and soil surveys. Chapter 3 discusses current statutory and regulatory requirements. Chapters 4 through 7 provide detailed information on BMPs for erosion and sedimentation control, dewatering operations, stormwater management, and vegetation for erosion control. Chapter 8 discusses how to develop an erosion and sedimentation control plan, which is the guiding document for describing who and what will control erosion at a specific site, and when, where, and how this will be done. Chapter 9 addresses inspection and enforcement issues.

¹ Chapter 6 of the *Florida Development Manual : A Guide to Sound Land and Water Management* contains an extensive discussion of the use, design, construction, and operation of a wide variety of stormwater management and erosion and sediment control BMPs (available at http://www.dep.state.fl.us/water/nonpoint/docs/nonpoint/eroded_bmp.pdf).

Tab
Insert

CHAPTER 1: EROSION AND SEDIMENTATION

- 1.1 The Erosion Process
- 1.2 Types of Water Erosion
- 1.3 Factors Influencing Erosion
 - 1.3.1 *Soil Characteristics*
 - 1.3.2 *Vegetative Cover*
 - 1.3.3 *Topography*
 - 1.3.4 *Climate (Rainfall)*
- 1.4 Impacts of Erosion and Sedimentation
 - 1.4.1 *Physical Impacts*
 - 1.4.2 *Biological Impacts*
- 1.5 Erosion and Sediment Hazards Associated with Land Development
- 1.6 Principles of Erosion and Sediment Control

* * * * *

1.1 The Erosion Process

Soil erosion is the process by which the land surface is worn away by the action of natural forces such as wind, water, ice, and gravity. It is caused when sediments are detached from the soil mass, transported primarily by flowing water or wind, and eventually deposited as sediment. **Water erosion** is caused when raindrops falling on bare or sparsely vegetated soil detach soil particles. Water flowing over the ground picks up the particles and carries them. As the runoff gains velocity, it forms channels and detaches more soil particles. This action cuts rills and gullies into the soil, adding to the sediment load. **Wind erosion** is also a significant cause of soil loss, especially in peninsular Florida. Winds blowing across unvegetated, disturbed land pick up soil particles and carry them along.²

Sedimentation is the settling out of soil particles transported by water and wind. It occurs when the velocity of water in which the particles are suspended is slowed to a sufficient degree, and for a sufficient period, to allow the particles to settle out of suspension. Heavier particles such as sand and gravel settle out more rapidly than fine particles such as clay and silt.

Sediment deposition occurs as the velocity of a sediment-transporting stream decreases. This is particularly important in Florida, where nearly all streams have low gradients and low velocities. Deposition, rather than transport, is therefore the dominant process in most Florida aquatic systems. If the available energy of the water is greater than the burden of the sediment load being transported, the moving water erodes the

² Additional information on wind erosion and its control is available from the NRCS (formerly the Soil Conservation Service) at <http://soils.usda.gov/>

soil to obtain additional sediment. If the load is greater than the available energy, some of the transported material is deposited.

Natural or **geologic erosion** has occurred at a relatively slow rate since the earth was formed. It is a major factor in creating the earth as we know it today. The great river valleys of the Florida Panhandle, the rolling farmlands and orchards of the Central Ridge, and the productive estuaries and barrier islands of the coast are all products of geologic erosion and sedimentation. Except for some cases of shoreline and stream channel erosion, natural erosion occurs at a very slow and uniform rate, and is a vital factor in maintaining environmental balance. Geologic erosion produces about 30% of all sediment in the United States.

Accelerated erosion is the increased rate of erosion caused primarily by the removal of natural vegetation or alteration of the ground contour. This type of erosion accounts for 70% of all sediment generated in this country. Farming and construction are the principal causes of accelerated erosion, although any activity that disturbs land can increase the natural erosion rate.

1.2 Types of Water Erosion

There are two principal types of water erosion: **overland erosion** and **sheet channel erosion**. Overland erosion occurs on denuded slopes when raindrops splash and run off. The largest source of sediment during construction activities, it includes the following:

1. **Raindrop erosion** or **splash erosion** results when raindrops dislodge soil particles and splash them into the air. These dislodged particles are then vulnerable to sheet erosion.
2. **Sheet erosion** is caused by shallow sheets of water flowing off the land. These broad, moving sheets of water are seldom the detaching agent, but the flow transports soil particles detached by raindrops. The shallow surface flow rarely moves as a uniform sheet for more than a few feet before concentrating in low spots on the land surface.
3. **Rill erosion** develops as the shallow surface flow begins to concentrate in low spots. The concentrated flow increases in velocity and turbulence, which in turn causes the detachment and transport of more soil particles. This action cuts tiny, well-defined channels called rills, which are usually only a few inches deep.
4. **Gully erosion** occurs as the flow in rills comes together in larger and larger channels. The major difference between this and rill erosion is size.

Stream channel erosion occurs as the volume and velocity of flow increase sufficiently to cause the movement of the streambed and bank materials.

1.3 Factors Influencing Erosion

The inherent erosion potential of an area is determined by four principal factors: soil characteristics, vegetative cover, topography, and climate (rainfall). Although each of these factors is discussed separately, they are inter-related.

1.3.1 Soil Characteristics

Soil properties that influence erosion by rainfall and runoff consist of those that affect the infiltration capacity of a soil and those that affect the resistance of the soil to detachment and transport by flowing or falling water. Four factors are important, as follows:

1. *Soil texture (average particle size and gradation).*
2. *Percentage of organic content.*
3. *Soil structure.*
4. *Soil permeability.*

Soils that contain high percentages of silt and very fine sand are generally the most erodible. As the clay and organic matter content of these soils increase, their erodibility decreases. Clays act as a binder of soil particles and reduce erodibility. However, while clays have a tendency to resist erosion, once detached from the soil they are easily transported by water and settle out very slowly.

Organic matter is plant and animal residue in various stages of decomposition. Soils high in organic matter have a more stable structure that improves their permeability. They resist raindrop detachment and absorb more rainwater, minimizing erosion. Well-drained and well-graded gravels and gravel-sand mixtures are the least erodible soils. Coarse gravel soils are highly permeable and have a good absorption capacity that either prevents or delays, and thus reduces, the amount of surface runoff. The study of soil characteristics related to soil erodibility is a complex, technical field. **Chapter 2** provides further information about soils.

The NRCS developed the Universal Soil Loss Equation (USLE) to help simplify the process of determining how much soil erosion will occur when using various conservation practices. However, the accuracy of the USLE in Florida is quite low. It is also not designed to quantify sediment yields from construction sites.

1.3.2 Vegetative Cover

Vegetative cover plays an extremely important role in controlling erosion:

1. *It shields the soil surface from the impact of falling rain.*
2. *It holds soil particles in place.*
3. *It maintains the soil's capacity to absorb water.*
4. *It slows the velocity of runoff.*
5. *It removes subsurface water through evapotranspiration.*

By sequentially scheduling (staging) and limiting the removal of vegetation, and by decreasing the area and duration of exposure, soil erosion and sedimentation can be significantly reduced. Special consideration should be given to maintaining vegetative cover on areas of high erosion potential, such as erodible soils, steep or long slopes, stormwater conveyances, and streambanks.

1.3.3 Topography

The size, shape, and slope of a watershed influence the amount and rate of runoff. Slope length and gradient are key elements in determining the volume and velocity of runoff and the erosion risks. As both slope length and gradient increase, the velocity and volume of runoff increase, and the erosion potential is magnified. Slope orientation can also be a factor in determining erosion potential.

1.3.4 Climate (Rainfall)

The frequency, intensity, and duration of rainfall are fundamental factors in determining the amount of runoff. As both the volume and the velocity of runoff increase, the capacity of runoff to detach and transport soil particles also increases. When storms are frequent, intense, or of long duration, erosion risks are high. Seasonal changes in rainfall and temperature define the period of the year with the highest risk of erosion.

Land-disturbing activities should be scheduled to take place during periods of low precipitation and low runoff. Exposed areas should be stabilized before the period of high erosion risk. Generally, Florida's wet season occurs from May to November, with a dry season from November to May. Check with your local water management district or FDOT office for more precise climate information in your area.

1.4 Impacts of Erosion and Sedimentation

Normally, runoff builds up rapidly to a peak and then diminishes. Erosion creates excessive quantities of sediment, principally during higher flows. During lower flows, as the velocity of runoff decreases, the transported materials are deposited, only to be picked up by later peak flows. In this way, sediments are carried downstream intermittently and progressively from their source. A study of sedimentation from highway construction and land development in Virginia indicated that 99% of sediment discharge occurred during periods of high flow that took place during only 3% of the period of measurement (Vice et al., 1969).

Over 4 billion tons (3.6 billion metric tonnes [t]) of sediment are estimated to reach the ponds, rivers, and lakes of our country each year, and approximately 1 billion tons (0.9 billion metric tonnes) of this sediment are carried all the way to the ocean. Approximately 10% of this amount is contributed by erosion from land undergoing highway construction or land development (SCS, 1980). Although this number may appear to be small compared with the total, it can represent more than half of the sediment load carried by many streams draining small watersheds undergoing development.

Sediment yields in streams flowing from established, urbanized drainage basins vary from approximately 200 to 500 tons per square mile per year (70 to 175 tonnes/square kilometer/year [t/km²/yr]). In contrast, areas actively undergoing urbanization often have a sediment yield of 1,000 to 100,000 tons per square mile per year (350 to 3,500 t/km²/yr) (USGS, 1968). Development is begun on an estimated 4,000 to 5,000 acres (1,620 to 2,025 hectares [ha]) of land throughout the country every day. This includes development for housing, industrial sites, and highway construction (U.S. Census Bureau, 1987). For very small areas, where construction activities have drastically altered or destroyed vegetative cover and the soil mantle, the sediment derived from 1

acre of land may be 20,000 to 40,000 times that obtained from adjacent undeveloped farm or woodland areas.

1.4.1 Physical Impacts

Excessive quantities of sediment result in costly damage to aquatic areas and to private and public lands. The obstruction of stream channels and navigable rivers by masses of deposited sediment reduces hydraulic capacity. This, in turn, causes an increase in flood crests, resulting in flood damage. Sediment fills stormwater conveyances and plugs culverts and stormwater systems, necessitating frequent and costly maintenance.

Municipal and industrial water supply reservoirs lose storage capacity, the usefulness of recreational impoundments is impaired or destroyed, navigable channels must continually be dredged, and the cost of filtering muddy water in preparation for domestic or industrial use becomes excessive. The added expense of water purification in the United States amounts to millions of dollars each year.

1.4.2 Biological Impacts

The biological effects of sedimentation are even more critical. The presence of fine-grained sediments (clays, silts, and fine sands) in an aquatic system reduces both the kinds and the amounts of organisms present. Sediments alter the aquatic environment by screening out sunlight and by changing the rate and the amount of heat radiation. This light reduction inhibits photosynthesis, leading to a decline in benthic plant growth. Consequently, the food chain is disrupted, and the population of consumer species is reduced.

The elimination or reduction of benthic organisms decreases the number and variety of food sources for fish, further disrupting the food chain and causing fish to either starve or move away. A moderate concentration of sediment can impair fish spawning, while a high concentration clogs the gills of fish and invertebrates. The result may be that clear waterbodies that once supported populations of game fish, such as bass and bream, become muddied and inhabited by more tolerant "trash" fish such as carp or suckers.

Coarser-grained materials also blanket bottom areas and suppress aquatic life found on and in these areas. Where currents are sufficiently strong to move the bed load, the abrasive action of these materials accelerates channel scour caused by, or associated with, higher flood stages induced by sedimentation.

1.5 Erosion and Sediment Hazards Associated with Land Development

Land development activities affect the natural or geologic erosion process by exposing disturbed soils to precipitation and to surface stormwater runoff. The shaping of land for development alters the land cover and the soil in many ways. These alterations often detrimentally affect onsite stormwater patterns and, eventually, offsite stream and streamflow characteristics. Protective vegetation is reduced or removed, earth is excavated, topography is altered, the removed soil material is stockpiled—often without protective cover—and the physical properties of the soil itself are changed.

The development process is such that many people may be adversely affected even by a small development project. Uncontrolled erosion and sediment from these areas often cause considerable economic damage to individuals and to society in general. The hazards associated with development include the following:

1. *A large increase in areas exposed to stormwater and soil erosion.*
2. *Increased volumes of stormwater, accelerated soil erosion and sediment yield, and higher peak flows caused by the following:*
 - a. Removal of existing protective vegetative cover.
 - b. Exposure of underlying soil or geologic formations that are less pervious and/or more erodible than the original soil surface.
 - c. Reduced capacity of exposed soils to absorb rainfall due to compaction caused by heavy equipment
 - d. Enlarged drainage areas caused by grading operations, diversions, and street construction.
 - e. Prolonged exposure of disturbed areas that are left unprotected due to scheduling problems or delayed construction.
 - f. Shortened periods of concentrated surface runoff caused by alterations in steepness, distance, and surface roughness, and by the installation of "improved" storm drainage facilities.
 - g. Increased impervious surfaces such as streets, buildings, sidewalks, and paved driveways and parking lots.
3. *Alteration of the ground water regime that may adversely affect stormwater systems, slope stability, and the survival of existing or newly established vegetation.*
4. *Creation of exposures facing south and west that may hinder plant growth due to adverse temperature and moisture conditions.*
5. *Exposure of subsurface materials that are rocky, acid, droughty, or otherwise unfavorable to the establishment of vegetation.*
6. *Adverse alteration of surface runoff patterns by construction and development.*

1.6 Principles of Erosion and Sediment Control

For an erosion and sediment control program to be effective, it is imperative that provisions for control measures be made in the planning stage. These planned measures, when conscientiously and expeditiously applied during construction, will result in orderly development without environmental degradation and with cost savings.

The seven principles listed below should be used to the maximum extent possible. Usually, these principles are integrated into a system of vegetative and structural measures, along with management techniques, that are used in developing a plan to prevent erosion and control sediment. In most cases, a combination of limited grading, limited time of exposure, and the judicious selection of erosion control practices and sediment-trapping facilities are the most practical methods of controlling erosion and the associated production and transport of sediment.

1. Plan the development to fit the particular topography, soils, drainage patterns, and natural vegetation of the site.

Detailed planning should be employed to ensure that roadways, buildings, and other permanent features of the development conform to the natural characteristics of the site. Large graded areas should be located on the most level portion of the site.

Slope length and gradient are key elements in determining the volume and velocity of runoff and its associated erosion. As both slope length and steepness increase, the rate of runoff increases and the potential for erosion is magnified. Where possible, steep vegetated slopes should be left undisturbed. Areas with slope and soils limitations should not be used unless sound conservation practices are employed. For instance, where it is necessary to build on long, steep slopes, the practices of benching, terracing, or constructing diversions should be used. Areas subject to flooding should be avoided or used as part of the stormwater management system. Floodplains should be kept free from filling and construction activities since they temporarily store excess runoff, thus helping to avoid erosion and flooding problems downstream.

Erosion control, development, and maintenance costs can be minimized by selecting a site suitable for a specific proposed activity, rather than by attempting to modify a site to conform to that activity. This kind of planning can be more easily accomplished where there is a general land use plan based on a comprehensive inventory of soils, water, and other related resources.

2. Minimize the extent of the area exposed at one time and the duration of exposure.

When land disturbances are required and the natural vegetation is removed, keep the area and the duration of exposure to a minimum. Plan the stages of development so that only the areas that are actively being developed are exposed. All other areas should have a good cover of either temporary or permanent vegetation, or mulch. Grading should be completed as soon as possible after it has begun. Immediately after grading is completed, a permanent vegetative cover should be established. As cut slopes are made and as fill slopes are brought up to grade, these areas also should be revegetated. This is known as staged revegetation. Minimizing the grading of large or critical areas during the rainy season (the time of maximum erosion potential) reduces the risk of erosion.

3. Apply perimeter control measures to protect the disturbed area from offsite runoff and to prevent sedimentation damage to areas below the development site.

These measures effectively isolate the development site from surrounding properties and, in particular, control sediment once it is produced, thus preventing its transport from the site. Diversions, berms, sediment traps, vegetative filters, and sediment basins are examples of practices to control sediment. Vegetative and structural sediment control measures are either temporary or permanent, depending on whether they will remain in use after development is complete. Generally, sediment is retained by (a) filtering runoff as it flows through an area and (b) impounding the sediment-laden runoff for a period so that the soil particles settle out. The best way to control sediment, however, is to prevent erosion, as discussed in the fourth principle.

4. Apply erosion control measures to prevent excessive onsite damage.

The use of erosion control measures on a site prevents excessive sediment from being produced. Keep soil covered as much as possible with temporary or permanent vegetation, or with various mulch materials. Special grading methods, such as roughening a slope on the contour or tracking with a cleated bulldozer, may be used. Other practices include diversion structures to direct surface runoff from exposed soil and grade stabilization structures to control surface water. These water control devices must prevent "gross" erosion in the form of gullies. Lesser types of erosion, such as sheet and rill erosion, should be prevented, but often scheduling or the large number of measures required makes this impractical. However, when erosion is not adequately controlled, sediment control is more difficult and expensive.

5. Keep runoff velocities low and retain runoff on the site.

The removal of existing vegetative cover and the resulting increase in impermeable surface area during development increase both the volume and velocity of runoff. These increases must be taken into account when providing for erosion control. Keeping slope lengths short and gradients low, and preserving natural vegetative cover, can keep stormwater velocities low and limit erosion hazards.

Runoff from the development site should be safely conveyed to a stable outlet using storm drains, diversions, stable waterways, or similar measures. Consideration should be given to installing stormwater detention structures to prevent flooding and damage to downstream facilities resulting from increased runoff from the site. Conveyance systems should be designed to withstand the velocities of projected peak discharges. These facilities should be operational as soon as possible after the start of construction.

6. Stabilize disturbed areas immediately after the final grade is attained.

Permanent structures, temporary or permanent vegetation, and mulch, or a combination of these measures, should be employed as quickly as possible after the land is disturbed. Temporary vegetation and mulches can be most effective under conditions where it is not practical to establish permanent vegetation. Such temporary measures should be employed immediately after rough grading is completed if a delay is anticipated in obtaining finished grade. The finished slope of a cut or fill should be stable, and the design should consider ease of maintenance. Stabilize roadways, parking areas, and paved areas with gravel sub-base whenever possible.

7. Implement a thorough maintenance and follow-up program.

This last principle is vital to the success of the six other principles. A site cannot be effectively controlled without thorough, periodic inspections of the erosion and sediment control practices. These practices must be maintained, just as construction equipment must be maintained and materials checked and inventoried. An example of applying this principle is to start a routine "end of day check" to make sure that all control practices are working properly.

Tab
Insert

CHAPTER 2: SOILS

- 2.1 Introduction to Soils
- 2.2 Soil Classification and Properties
 - 2.2.1 Soil Classification
 - Soil Texture
 - Soil Hydrologic Group
 - 2.2.2 Soil Properties
 - Erodibility
 - Slope
 - Shrink-Swell Potential
 - Flood Hazard
 - Soil Reaction (pH)
 - Wetness
 - Depth to Bedrock
- 2.3 Soil Surveys

* * * * *

2.1 Introduction to Soils

To effectively prevent erosion and minimize sedimentation, an understanding of different soil types and their properties is essential. Soils form in response to the interaction of five factors: climate, relief, organisms, parent material, and time. Soils form in the parent material, known as the C horizon.³ Marine sands, weathered limestone, and organic deposits are the common parent materials found in Florida soils.

A **soil profile** develops as parent material is transformed into soil by soil-forming processes. The accumulation of organic matter in O and A horizons, the leaching of nutrients from A and E horizons, and the translocation and synthesis of clay to form B horizons are examples of soil-forming processes that create horizons within a profile. A soil profile has two or more horizons.

Young soils (A over C horizons) are common in Florida. A soil is said to mature, or age, as the B horizon accumulates clay. Soils with spodic horizons, commonly found in Florida, are B horizons that have an accumulation of organics, iron, and aluminum from the overlying soil. Soil horizons can differ in chemical and physical properties, such as thickness, texture, color, organic matter, fertility, and pH.

On a volume basis, average topsoil (the A horizon) is 45% minerals, 5% organic matter, and 50% pore space. With depth, organic matter, porosity, and permeability decrease.

³ A horizon consists of a layer of soil parallel to the soil surface whose physical characteristics differ from the layers above and below it. Each horizon is identified by a capital letter, and the layers within each horizon are identified using lowercase letters. A is the surface horizon, B is subsoil, and C is the substratum. Most soils comprise the A, B, and C horizons. E is a subsurface horizon with significant mineral loss. O, the organic horizon, can be either buried or on the surface. R is hard bedrock.

Topsoil has the greatest amount of plant and microbial activity. It is important as a seedbed, a reservoir for nutrients and water, and in the exchange of gases between the subsoil and atmosphere. The topsoil is the horizon most vulnerable to erosion and human activities.

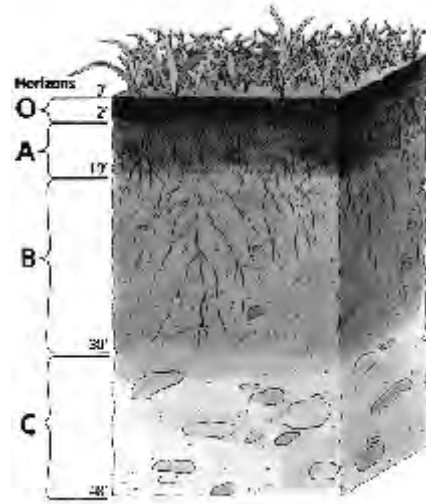

Geologic erosion is a natural, ongoing process. Equilibrium between erosion and topsoil formation is established for each particular location within a given area. The soil loss tolerance (T value) is an estimate of the maximum amount of annual erosion that a soil can tolerate without a decrease in crop yield. Some of our most fertile regions are floodplain soils that were deposited from eroded upland topsoil.

However, accelerated erosion due to human activities has detrimental impacts onsite and downstream. Soil behavior and morphology (structure) change in response to any change in the five soil-forming factors. **In Florida, clay and muck are the two soils that cause the most problems with turbidity and erosion.**

2.2 Soil Classification and Properties

2.2.1 Soil Classification

Soil engineers and agricultural scientists describe the properties of soils differently because their interests are substantially different. Both soil and civil engineers are familiar with the unified and American Association of State Highway and Transportation Officials (AASHTO) systems, which focus on the engineering properties of soils. These classifications are based on the physical properties of the soil. Initially, soils are described as either coarse- or fine-grained. Coarse-grained soils are further described by the degree of sorting of particle sizes. Fine-textured soils are further distinguished by their liquid and plasticity limits. Particle size analysis is not usually performed.

In contrast, the USDA system of soil classification, used by the agency's NRCS, focuses on the characteristics of soils that are important for agricultural uses, such as texture, organic matter, and nutrient content. A particle size analysis is necessary before a soil can be classified using the USDA system. In the USLE, since it was originally developed for use in agricultural areas, the USDA system is used.

Soil Texture

Soil texture depends on the proportions (by weight) of sand, silt, and clay in a soil—often referred to as the particle size distribution. **Table 2.1** lists the USDA particle size classes. A triangle is used to categorize soil textures based on their particle size content (see **Figure 2.2**).

The percentages of sand, silt, and clay in a soil add up to 100. By knowing any two components, one can find the texture name for the soil. For example, a soil with 40% sand and 40% silt is called a loam. A loam also contains 20% clay. A sample with 20% sand and 60% silt is called a silt loam, while one with 60% sand and 30% silt is called a sandy loam.

Table 2.1. USDA Particle Size Classes

Particle Name	Size (millimeters [mm])
Gravel	> 2.0
Sand	2.0 – 0.1
Very Fine Sand	0.1 – 0.05
Silt	0.05 – 0.002
Clay	< 0.002

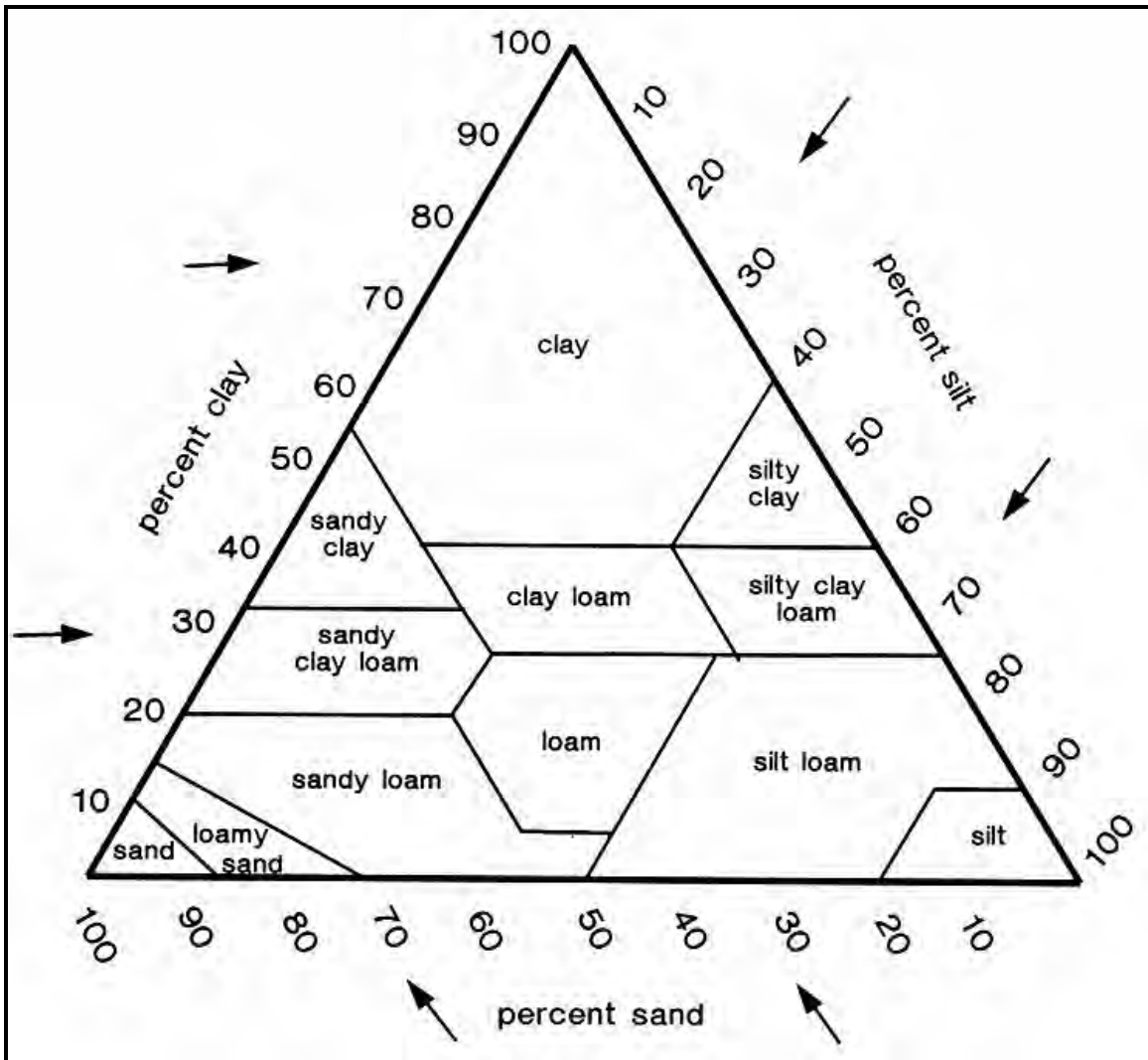

Figure 2.2. Guide to the Textural Classification of Soils

Source: *Erosion and Sediment Control Handbook*, Goldman et al., 1988.

The unified and AASHTO classification systems use a different particle size than the USDA system to differentiate silt from sand; the former change the classification at 0.74 mm, the latter at 0.05 mm. This difference is important because the silt and very fine sand particles in this size range are most susceptible to erosion and are therefore of interest in erosion control planning.

The particle size also is important because the ability of a sediment basin to trap soil is primarily related to particle size. The smaller the particle, the larger the basin must be to capture it. Each sediment basin should be designed to capture a certain size particle called the **design particle**. If a soils analysis is to be done on a site, the site planner should request that the design particle size be specified as a threshold in the analysis (i.e., specify the percent, by weight, of particles larger or smaller than that size).

Sandy soils generally have a higher permeability than fine-textured soils. The amount of runoff is lower, and since the particles are relatively large (and thus heavy), they are not carried far in any runoff that does occur. Sand particles settle out of runoff at the bottom of a slope or in a channel with a gentle slope. Very fine sand particles, however, behave like silt particles.

Silt is the most important particle size class when soil erodibility is evaluated. The higher the silt content, the more erodible a soil is. Silt-sized particles are small enough to reduce the permeability of a soil and are also easily carried by runoff. Control measures should be designed to prevent the erosion of silt, or at least to contain it onsite.

Clay is the smallest particle size class. A soil with high clay content is quite cohesive—the particles stick together in clumps. Runoff does not pick up clay particles as easily as it does silt. However, once clays are suspended in runoff, they will not settle out until they reach a large, calm waterbody. These very small particles have so low a settling velocity that they are carried long distances until still water is reached, or until salt water causes them to clump together again in aggregates.

It is easiest to prevent the erosion of sandy soils. Silts are most susceptible to erosion, but they can be recaptured onsite by applying the control measures described in **Chapter 4**. Clays are the most difficult to trap once erosion has occurred, and thus control measures must focus on preventing their erosion in the first place.

Although texture is a principal soil characteristic affecting erodibility, three other characteristics have a strong influence on erosion potential: organic matter, soil structure, and permeability.

Organic Matter. Organic matter within a soil is mostly made up of decomposed plant and animal litter. It consists of colloidal particles as small as and smaller than clay particles. This kind of organic matter helps bind the soil particles together, improves soil structure, and increases permeability and water-holding capacity. Soils with organic matter are less susceptible to erosion and more fertile than soils without organic matter.

On a construction site, where extensive grading has removed the original topsoil and exposed layers of earth that have no plant roots growing in them, there is no organic matter. Such subsoils are likely to be more erodible and less fertile than surface soils.

In another sense of the term, organic matter means plant residue, or other organic material, that is applied to the soil surface. Surface-applied mulch reduces erosion by reducing the impact of raindrops, and by absorbing water and reducing runoff. It provides a more hospitable environment for plant establishment, and it eventually decomposes and improves the structure and fertility of the soil. **Chapter 7** describes the uses of mulch in erosion control.

Soil Structure. Soil structure refers to the arrangement of particles in a soil. In an undisturbed soil with established vegetation, organic matter binds the particles into clumps called aggregates, producing what is called a granular structure. This is desirable because permeability and water-holding capacity are increased and the clumped particles are more resistant to erosion.

The grading and compaction of soils during construction destroy their natural structure, reduce permeability, and increase runoff and erodibility. The direct impact of raindrops on a soil unprotected by mulch or vegetation also breaks up soil aggregates and increases erodibility.

Soil Permeability. Soil permeability refers to the ability of the soil to allow air and water to move through it. **Table 2.2** lists the USDA permeability classes. Soil texture, structure, and organic matter all contribute to permeability. Sites with highly permeable soils absorb more rainfall, produce less runoff, are less susceptible to erosion, and support plant growth more successfully.

Graded areas must meet certain standards of compaction to ensure a stable foundation surface. The infiltration of water into a large fill is *not* desirable because it may reduce the fill's stability. Compaction increases stability, but by lessening the amount of infiltration, soil permeability is reduced and surface runoff and surface erosion increase. When grass is planted on fills and paved diversion ditches are installed mid-slope to carry away excess runoff, surface erosion is reduced.

Table 2.2. USDA Soil Permeability Classes

Permeability Class	Estimated Inches Per Hour through Saturated, Undisturbed Cores under ½-Inch Head of Water
Very Slow	< 0.06
Slow	0.06 – 0.2
Moderately Slow	0.2 – 0.6
Moderate	0.6 – 2.0
Moderately Rapid	2.0 – 6.0
Rapid	6.0 – 20
Very Rapid	> 20

Soil Hydrologic Group

The hydrologic soil group is a direct reflection of the infiltration rate of the soil. The hydrologic soil groups, according to their infiltration and transmission rates, are as follows:

1. *Soils having high infiltration rates even when thoroughly wetted (low runoff potential);*
2. *Soils having moderate infiltration rates when thoroughly wetted;*
3. *Soils having slow infiltration rates when thoroughly wetted; and*
4. *Soils having very slow infiltration rates when thoroughly wetted (high runoff potential).*

2.2.2 Soil Properties

The properties of soil at a construction site should be identified for planning purposes. Each soil type has different characteristics, including permeability, infiltration, seasonal wetness, depth to the water table, depth to bedrock, texture, shrink-swell potential, erodibility, and slope. Variations in the properties of soil affect its ability to support heavy loads, to serve as a medium for wastewater or solid waste disposal, to percolate rainwater, to hold its shape and slope after excavation, or to grow vegetation. The following sections describe important soil characteristics.

Erodibility

The major soil consideration in controlling erosion and sedimentation is erodibility. An erodibility factor (K) indicates the susceptibility of different soils to the forces of erosion. A soil survey report includes the K factor for each soil survey area. These K factors are used in the USLE to determine soil loss from an area over time due to splash, sheet, and rill erosion. K factors in Florida range from about 0.10 (the lowest erodibility) to about 0.49 (the highest erodibility). K factors are grouped into three general ranges, as follows:

- *0.23 and lower – low erodibility;*
- *0.23 to 0.36 – moderate erodibility; and*
- *0.36 and up – high erodibility.*

The cohesiveness of soil particles varies within different layers of the same soil, causing varying degrees of erodibility at different depths. Therefore, the depth of excavation must be considered in determining soil erodibility on a construction site.

Slope

Slope ranges are recorded in soil surveys, and areas where cuts and fills should be avoided can be identified by studying soil maps. The longer and steeper the slope, the greater the potential for soil loss due to the increased velocity of surface runoff.

Shrink-Swell Potential

Certain soils have clays that shrink when dry and swell when wet. In this situation, special foundations are required to allow for this variation. By consulting the soil survey, soils with these problems can be identified and the necessary precautionary steps can be taken. It should be kept in mind, however, that soil surveys do not always reflect geologic phenomena in the zone beneath the soil; thus, when shrink-swell conditions occur only deep in the soil profile, the soil survey may not be an accurate guide.

Flood Hazard

Although soil survey information does not take the place of hydrologic studies, it does provide estimates of where floods are most likely to occur. The hazards of flooding and ponding are rated in soil surveys, and flood-prone areas are shown on soil maps.

Soil Reaction (pH)

Soil survey information on the pH of the individual layers of each soil is useful when planning to establish vegetation on a construction site.

Wetness

The many types of data available in soil surveys include natural soil drainage, depth to seasonal water table, and suitability for winter grading of various kinds of soils. With this information, engineers can make determinations such as seasonal limitations that should be placed on the use of heavy earth-moving machinery and estimations of potential flood hazards or damage to underground structures due to soil wetness.

Depth to Bedrock

Soil surveys indicate bedrock types and in what areas they will be encountered at a depth of less than 5 to 6 feet (1.75 to 2 meters [m]). This information is very helpful in determining suitable locations for stormwater management facilities, or the time and cost of excavation.

2.3 Soil Surveys

Soil surveys are proven to save time and money, and their use results in improved designs, more effective planning, and more accurate preliminary estimates of construction costs. References to soil maps and accompanying supporting data in soil surveys enable developers to determine the soil conditions in proposed construction areas.

Knowing the types of soil, the topography, and surface drainage patterns is beneficial in planning and designing almost any type of land development project and is essential for erosion control planning. In many instances, a major soil-related problem is discovered after a site has been selected and construction is either well under way or in some cases completed. These problems often necessitate delays in construction and ultimately increase the total cost of the project. By consulting a soil survey during the planning process prior to construction, compensating designs can be prepared in advance or alternate sites can be selected.

Soil surveys in Florida are conducted as a joint effort by the NRCS, the Agricultural Experiment Stations of the University of Florida, and the local Soil and Water Conservation Districts. Soil surveys have been published for most Florida counties. Additional soils information may be obtained by contacting the local representative of any of these agencies in your area or at the NRCS website at <http://soils.usda.gov>.

Tab
Insert

CHAPTER 3: REGULATIONS AND STATUTORY REQUIREMENTS

- 3.1 Introduction
- 3.2 NPDES Stormwater Permitting Regulations and Statutory Requirements
 - 3.2.1 Construction Activities
 - 3.2.2 Larger Common Plan of Development
 - Operator
 - Obtaining CGP Coverage
 - Key CGP Requirements
 - Contents of an SWPPP
 - Narrative Report
 - Certification Requirement
 - Contractor Certification Requirement
 - SWPPP Update Requirements
 - Posting a Copy of the NOI
 - Inspections
 - Retention of Records
 - Notice of Termination
 - Dewatering
 - General Comments
- 3.3 Construction Stormwater Pollution Prevention Plan Template
 - 3.3.1 Stormwater Pollution Prevention Plan

3.1 Introduction

To minimize the adverse impacts of runoff, Florida was the first state in the country to require stormwater treatment from all new development with the implementation of the State Stormwater Rule in 1982. This technology-based rule includes a goal (the performance standard) and design criteria for different types of stormwater treatment BMPs, such as retention or wet detention systems.

Today, a Florida ERP must be obtained from the applicable water management district or FDEP office before construction begins. ERPs integrate stormwater quantity and quality, as well as wetland protection requirements, into a single permit. They regulate activities such as dredging and filling in wetlands, the construction of stormwater facilities, stormwater treatment systems, the construction of dams or reservoirs, and other activities affecting state waters. Each water management district has an operating agreement with FDEP about which agency will process ERPs for particular projects, based on the type of land use or activity.

Specific requirements for stormwater management, including erosion and sediment control during land disturbance, flood control, and stormwater treatment, are found in the specific ERP regulations applicable within the appropriate water management district. These requirements include specific design criteria for various types of stormwater treatment practices. Additional details about these regulations are available at <http://www.dep.state.fl.us/water/wetlands/erp/index.htm> or <http://flwaterpermits.com>.

It is important to note that the permit required under FDEP's National Pollutant Discharge Elimination System (NPDES) Stormwater Program is separate from the ERP required under Part IV, Chapter 373, F.S., or any local government's stormwater discharge permit for construction activity.

The FDEP/water management district ERP Program benefits Florida by requiring the implementation of effective mitigation measures that will minimize stormwater pollution to Florida's lakes and streams and protect wetlands (see <http://www.flwaterpermits.com>).

Developers need to identify within which of the five water management districts (see the map below) their project is located to ensure that all permits and environmental issues are properly addressed within their SWPPP. Also, it will be necessary to contact the appropriate water management district office for specific ERP and dewatering permit requirements.

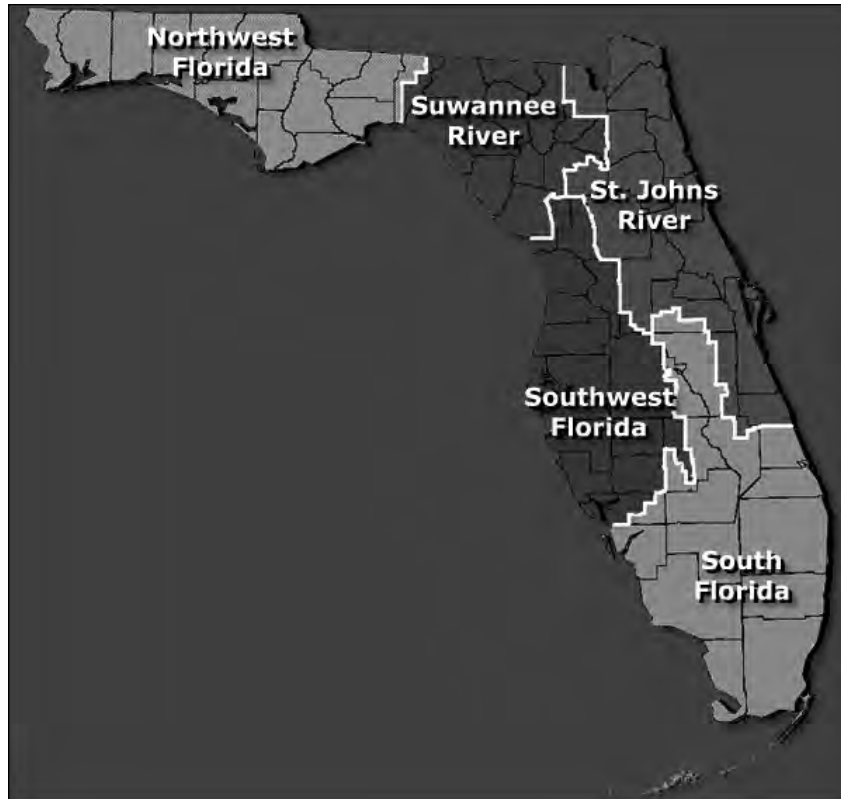

In 2000, the EPA authorized FDEP to implement the NPDES Stormwater Program within the state, except for Native American tribal lands. Mandated by the revisions to the federal Clean Water Act adopted by Congress in 1987, the NPDES Program is a national program for addressing many urban stormwater discharges that may adversely impact water quality.

The NPDES Stormwater Program is completely separate from the state's environmental resource permitting programs authorized by Part IV, Chapter 373, F.S. The NPDES Program does not establish additional regulations for construction/design features for retention areas, detention ponds, swales, and other stormwater management systems. The permit required under FDEP's NPDES Program is also separate from any local government's stormwater discharge permit for construction activity.

3.2 NPDES Stormwater Permitting Regulations and Statutory Requirements

The sources of stormwater discharges regulated under the NPDES Stormwater Program include the following three categories:

- *Construction activities (addressed in this chapter),*
- *Industrial activities, and*
- *Municipal separate storm sewer systems (MS4s).*

3.2.1 Construction Activities

Stormwater runoff from construction activities can have a significant impact on water quality by contributing sediment and other pollutants to waterbodies. The term "construction activity" means the act or process of developing or improving land that involves the disturbance of soils and includes clearing, grading, and excavation. Based on EPA guidance, FDEP has determined that demolition activities also meet the definition of construction activities.

The NPDES Stormwater Program regulates construction activities that disturb one or more acres of land and discharge stormwater to surface waters of the state or into an MS4. (The regulatory definition of an MS4 is "a conveyance or system of conveyances like roads with stormwater systems, municipal streets, catch basins, curbs, gutters, ditches, constructed channels, or storm drains.") If a project is less than one acre, but part of a larger common plan of development or sale that will ultimately disturb one or more acres, permit coverage is also required.

3.2.2 Larger Common Plan of Development

A larger common plan of development or sale is a contiguous area where multiple separate and distinct construction activities may be taking place at different times and on different schedules under a single plan. The classic example is the construction of a subdivision. If a developer buys a 20-acre parcel, and builds roads and installs water/sewer with the intention of constructing homes or other structures in the future, this is considered a larger common plan or development or sale. If the land is parceled off or sold, and construction occurs on plots that are less than 1 acre by separate,

independent builders, this activity still is subject to NPDES stormwater permitting requirements if the smaller plots are included in the original site plan, regardless of the size of any of the individually owned plots (¼ acre, ½ acre, etc.).

3.2.3 CGP Permit

Responsibilities of the Operator

The Generic Permit for Stormwater Discharge from Large and Small Construction Activities (CGP) (FDEP Document 62-621.300[4][a], effective May 2003) defines the term “operator” as follows:

“ . . . the person, firm, contractor, public organization, or other legal entity that owns or operates the construction activity and that has authority to control those activities at the project to ensure compliance with the terms and conditions of this permit.”

The operator is ultimately responsible for obtaining permit coverage and implementing appropriate pollution prevention techniques to minimize erosion and sedimentation from stormwater discharges during construction. The operator is the entity with sufficient authority to ensure compliance with the permit requirements. Typically, the operator is the owner, developer, or general contractor. Generally, the architect/engineer should not be listed as the operator unless that individual has operational control over the project and is willing to accept responsibility for compliance with the permit.

For construction projects where the operator changes, the new operator should obtain permit coverage at least 2 days before assuming control of the project, and the previous operator should file an NPDES Stormwater Notice of Termination (FDEP Form 62-621.300[6]) within 14 days of relinquishing control of the project to a new operator. The previous operator must meet the conditions to terminate coverage in accordance with Part VIII of the CGP.

Obtaining CGP Coverage

To obtain NPDES stormwater permit coverage, a regulated construction operator must complete the following steps:

1. *Obtain and carefully read the CGP (available online at: <http://www.dep.state.fl.us/water/stormwater/npdes/construction3.htm>).*
2. *Develop a site-specific SWPPP.*
3. *Complete in its entirety the application or Notice of Intent (NOI) (FDEP Form 62-621.300[4][b]).*
4. *Submit the NOI with the appropriate processing fee to the NPDES Stormwater Notices Center:⁴*
 - a. *The processing fee is required by Rule 62-4.050(4)(d), F.A.C. (available at <http://www.dep.state.fl.us/legal/Rules/mainrulelist.htm> or <https://www.flrules.org/gateway/RuleNo.asp?ID=62-4.050>).²*

⁴ The fee is subject to change, so check the rule to determine the appropriate fee when applying.

- b. Do not send plans or a copy of the SWPPP when applying for permit coverage. Only the NOI and appropriate fee are required. If the project site is inspected, FDEP or a designated representative will review the contents of the SWPPP at the time of the inspection. (FDEP may also request at any time that the SWPPP be submitted for review.)
- c. For projects that discharge stormwater to an MS4, a copy of the NOI must also be submitted to the operator of the MS4. A list of current MS4 permittees is available at http://www.dep.state.fl.us/water/stormwater/npdes/MS4_1.htm.

Operators seeking coverage under the CGP must apply for permit coverage at least two days before construction begins. Permit coverage under the CGP is effective two days after the date of submittal of a complete NOI and appropriate fee. Submittal is interpreted as “postmarked.” NOIs should be mailed to the following address:⁵

*Florida Department of Environmental Protection
NPDES Stormwater Notices Center, MS#2510
2600 Blair Stone Road
Tallahassee, Florida 32399-2400*

The NPDES Stormwater Notices Center will send an acknowledgment letter to the operator after reviewing and processing the complete NOI and fee. The acknowledgment or confirmation letter identifies the permit or project number for the activity and indicates the issuance and expiration date for the CGP. Permit coverage under the CGP is limited to five years. If a construction activity extends beyond a period of five years, the operator is required to reapply for permit coverage.

Key CGP Requirements

The major CGP requirements are as follows (for a complete summary of the regulatory requirements, always refer to the CGP):

- *Develop and implement an SWPPP;*
- *Post a copy of the NOI or acknowledgment letter;*
- *Undergo inspections;*
- *Retain records; and*
- *Submit a Notice of Termination (NOT).*

Contents of an SWPPP

The SWPPP must identify potential sources of pollution that may reasonably be expected to affect the quality of stormwater discharge associated with construction activity. In addition, the plan shall describe and ensure the implementation of BMPs that will be used to reduce the pollutants in stormwater discharge associated with construction activity and ensure compliance with the terms and conditions of the permit.

⁵ FDEP is developing a web-based system that will allow the submittal of NOIs online.

A thorough understanding of the plan is essential for proper implementation and maintenance.

The SWPPP must be developed before an NOI is filed in order to receive CGP coverage and must meet or exceed FDEP requirements. Also, beginning on the first day of construction activities, the SWPPP must be available at the location identified in the NOI.

A SWPPP should consist of a narrative and a site map. The CGP also requires a certification statement to be signed by the operator. The SWPPP must be developed and implemented for each construction site covered by this generic permit and must be prepared in accordance with good engineering practices.

Narrative Report

The narrative report provides general information on the activities that will be completed to ensure minimal environmental damage as a construction project proceeds. It should briefly describe the overall strategy for erosion and sediment control, as well as summarize the aspects of the project that are important for erosion control onsite for the plan reviewer and project superintendent.

The narrative report shall include a site description and, at a minimum, the following information about the site:

- *Description of the construction activity;*
- *Intended sequence of major soil-disturbing activities;*
- *Total area of the site and total disturbance area;*
- *Description of the soils and an estimate of the size of the drainage area for each discharge point;*
- *Latitude and longitude of each discharge point and the name of the receiving water for each discharge point; and*
- *Site map indicating drainage patterns and slopes, areas of soil disturbance, undisturbed areas, locations of BMPs, stabilization areas, surface waters/wetlands, and discharge points.*

Each plan must include a description of the appropriate controls, BMPs, and measures that will be implemented at the construction site. The plan must clearly describe for each major soil-disturbing activity the appropriate control measures and the timing for implementing these measures. Control measures include the following:

- *Erosion and sediment controls such as stabilization practices, structural practices, and sediment basins;*
- *Permanent stormwater management controls to control pollutants during construction and after construction operations have been completed; and*
- *Controls for other potential pollutants such as waste disposal, offsite vehicle tracking, the proper application of fertilizers/herbicides/pesticides, and the proper storage of toxic materials. **The permit does not authorize the discharge of solid materials to surface waters of the state or an MS4.***

Maintenance and inspections of structural (e.g., sediment control) and nonstructural (e.g., erosion control) BMPs are important aspects of the CGP and must be addressed in the SWPPP. The narrative report should briefly describe the procedures that will be followed to ensure the timely installation, inspection, and maintenance of vegetation, erosion and sediment controls, stormwater management practices, and other protective measures and BMPs so they will remain in good and effective operating condition.

The plan shall also identify and ensure the implementation of appropriate pollution prevention and treatment measures for nonstormwater components of the discharge. Common nonstormwater discharges include discharges from fire-fighting activities, fire hydrant/waterline flushings, water used to spray off loose solids from vehicles, water for dust control, and irrigation drainage.

Certification Requirement

The preparer of the SWPPP or responsible authority must sign and date the following certification statement as part of the SWPPP:

"I certify under penalty of law that this document and all attachments were prepared under my direction or supervision in accordance with a system designed to assure that qualified personnel properly gathered and evaluated the information submitted. Based on my inquiry of the person or persons who manage the system, or those persons directly responsible for gathering the information, the information submitted is, to the best of my knowledge and belief, true, accurate, and complete. I am aware that there are significant penalties for submitting false information. These include the possibility of fine and imprisonment for knowing violations."

Contractor Certification Requirement

All contractors and subcontractors identified in the SWPPP, or those selected at a later date, **must** sign and date the following certification statement before conducting land-disturbing activities on the site:

"I certify under penalty of law that I understand, and shall comply with, the terms and conditions of the State of Florida Generic Permit for Stormwater Discharge from Large and Small Construction Activities and this Stormwater Pollution Prevention Plan prepared there under."

SWPPP Update Requirements

The SWPPP is a dynamic document that provides a first appraisal of where to install BMPs on construction sites. Consequently, the SWPPP must be revised within seven calendar days following an inspection when additions and/or modifications to BMPs are necessary to correct observed problems. The plan should be revised under the following conditions:

- *Whenever a change in design, construction, operation, or maintenance at the construction site has a significant effect on the discharge of pollutants to surface waters of the state or to an MS4 system.*
- *Whenever the plan proves to be ineffective in eliminating or significantly minimizing pollutants from sources or in otherwise achieving the general*

objectives of controlling pollutants in stormwater discharge associated with construction activity.

Posting a Copy of the NOI

A copy of the NOI or acknowledgment letter from FDEP confirming coverage must be posted at the construction site in a prominent place for viewing (such as alongside the building permit).

Inspections

One of the key components of the CGP is the requirement for a **qualified inspector** to inspect all points of discharge into any surface waters (including wetlands) or an MS4. Disturbed areas, material storage areas, structural controls, and vehicle ingress/egress areas must be inspected and documented at least once every 7 calendar days and within 24 hours of the end of a storm event that is ½ inch or greater.

A qualified inspector is defined in the CGP as one of following:

1. *Has successfully completed and met all requirements necessary to be fully certified through the FDEP Stormwater, Erosion, and Sedimentation Control Inspector Training Program;*
2. *Has successfully completed an equivalent formal training program (typically in other states);*
3. *Is qualified by other training or practical experience in the field of stormwater pollution prevention and erosion and sedimentation control.*

FDEP recommends that inspectors become certified under the Inspector Training Program.

Inspections must be documented and signed by a qualified inspector. If the inspection reveals that the activity is in compliance with the SWPPP and CGP, the report must contain a certification statement indicating that the facility is in compliance. Major observations and incidents of noncompliance should also be recorded in the inspection report, as well as corrective actions and maintenance. Deficiencies and maintenance must be corrected and documented within seven calendar days following the inspection.

Retention of Records

The permittee shall retain copies of the SWPPP and all reports required by the CGP, and records of all data used to complete the NOI to be covered by the CGP, for at least 3 years from the date that the site is finally stabilized. The permittee shall retain a copy of the SWPPP and all reports, records, and documentation required by the CGP at the construction site, or an appropriate alternative location as specified in the NOI, from the date of project initiation to the date of final stabilization.

Notice of Termination

Upon completion of the project and final stabilization, the permittee should submit a completed NOT to the NPDES Stormwater Notices Center and the MS4, if applicable. The elimination of stormwater discharges associated with construction activity means that all disturbed soils at the site have been finally stabilized and temporary erosion and

sediment control measures have been removed or will be removed at an appropriate time.

Final stabilization is defined within the CGP as follows: “all soil disturbing activities at the site have been completed, and . . . a uniform (e.g., evenly distributed, without large bare areas) perennial vegetative cover with a density of at least 70% for all unpaved areas and areas not covered by permanent structures has been established or equivalent permanent stabilization measures (e.g., geotextiles) have been employed.”

The NOT should be sent to the following address:

*NPDES Stormwater Notices Center
Florida Department of Environmental Protection
2600 Blair Stone Road, MS #2510
Tallahassee, FL 32399-2400
(866) 336-6312 (toll free)*

Dewatering

Discharges resulting from ground water dewatering activities at construction sites **are not covered** under the CGP. Dewatering activities may require permit coverage under FDEP’s Generic Permit for the Discharge of Produced Ground Water from any Non-contaminated Site Activity under Rule 62-621.300(2), F.A.C. In addition, dewatering may require an authorization or exemption from the local water management district.

3.3 Construction Stormwater Pollution Prevention Plan Template

The following template may be used as a general guide for development of a SWPPP for construction activities. This template may not contain all applicable requirements for all construction sites. Please refer to FDEP’s CGP, FDEP Document 62-621.300(4)(a), to verify that you are meeting all permit requirements. Part V of the above referenced generic permit specifically lists the requirements of the SWPPP, as follows:

- *The SWPPP shall be completed prior to the submittal of the NOI to be covered under the CGP.*
- *The SWPPP shall be amended whenever there is a change in design, construction, operation, or maintenance that has a significant effect on the potential for discharge of pollutants to surface waters of the state or an MS4. The SWPPP also shall be amended if it proves to be ineffective in significantly reducing pollutants from sources identified in Part V.D.1. of the permit. The SWPPP also shall be amended to indicate any new contractor and/or subcontractor that will implement any measure of the SWPPP. All amendments shall be signed, dated, and kept as attachments to the original SWPPP.*

3.3.1 Stormwater Pollution Prevention Plan

"I certify under penalty of law that this document and all attachments were prepared under my direction or supervision in accordance with a system designed to assure that qualified personnel properly gathered and

evaluated the information submitted. Based on my inquiry of the person or persons who manage the system, or those persons directly responsible for gathering the information, the information submitted is, to the best of my knowledge and belief, true, accurate, and complete. I am aware that there are significant penalties for submitting false information, including the possibility of fine and imprisonment for knowing violations."

Name (Operator and/or Responsible Authority)

Date

Project Name and Location Information:	
---	--

A site map must be developed and must contain, at a minimum, the following information:

1. *Drainage patterns;*
2. *Approximate slopes after major grading activities;*
3. *Areas of soil disturbance;*
4. *An outline of all areas that are not to be disturbed;*
5. *The locations of all major structural and nonstructural controls;*
6. *The locations of expected stabilization practices;*
7. *Wetlands and surface waters; and*
8. *Locations where stormwater may discharge to a surface water or MS4.*

Site Description

Describe the nature of the construction activity:					
Describe the intended sequence of major soil-disturbing activities:					
Total area of the site:	Acres				
Total area of the site to be disturbed:	Acres				
Existing data describing the soil or quality of any stormwater discharge from the site:					
Estimate the drainage area size for each discharge point:	<table border="1" style="width: 100%; border-collapse: collapse;"> <tr><td style="height: 20px;"></td></tr> <tr><td style="height: 20px;"></td></tr> <tr><td style="height: 20px;"></td></tr> <tr><td style="height: 20px;"></td></tr> </table>				
Latitude and longitude of each discharge point and identify the receiving water or MS4 for each discharge point:	<table border="1" style="width: 100%; border-collapse: collapse;"> <tr><td style="height: 20px;"></td></tr> <tr><td style="height: 20px;"></td></tr> <tr><td style="height: 20px;"></td></tr> <tr><td style="height: 20px;"></td></tr> </table>				
<p>Give a detailed description of all controls, BMPs, and measures that will be implemented at the construction site for each activity identified in the intended sequence of major soil-disturbing activities section. Provide time frames in which the controls will be implemented. NOTE: All controls shall be consistent with performance standards for erosion and sediment control and stormwater treatment set forth in Section 62-40.432, F.A.C., the applicable stormwater permitting or ERP requirements of FDEP or a water management district, and the guidelines contained in the <i>Florida Development Manual: A Guide to Sound Land and Water Management</i> (Florida Department of Environmental Regulation [FDER], 1988) and any subsequent amendments.</p>					
<p>Describe all temporary and permanent stabilization practices. These include temporary seeding, mulching, permanent seeding, geotextiles, sod stabilization, vegetative buffer strips, protection of trees, vegetative preservation, etc.</p>					

--

Describe all structural controls to be implemented to divert stormwater flow from exposed soils and structural practices to store flows, retain sediment onsite, or in any other way limit stormwater runoff. These controls include silt fences, earth berms, diversions, swales, sediment traps, check dams, subsurface drains, pipe slope drains, level spreaders, storm drain inlet protection, rock outlet protection, reinforced soil-retaining systems, gabions, coagulating agents, and temporary or permanent sediment basins.

--

Describe all sediment basins to be implemented for areas that will disturb 10 or more acres at a time. The sediment basins (or an equivalent alternative) should be able to provide 3,600 cubic feet of storage for each acre drained. Temporary sediment basins (or an equivalent alternative) are recommended for drainage areas under 10 acres.

--

Describe all permanent stormwater management controls such as, but not limited to, detention or retention systems or vegetated swales that will be installed during the construction process.

--

Describe in detail controls for the following potential pollutants

Waste disposal (this may include construction debris, chemicals, litter, and sanitary wastes):	
Offsite vehicle tracking from construction entrances/exits:	
The proper application rates of all fertilizers, herbicides, and pesticides used at the construction site:	
The storage, application, generation, and migration of all toxic substances:	
Other:	

Provide a detailed description of the maintenance plan for all structural and nonstructural controls to assure that they remain in good and effective operating condition:

--

Describe the inspection and inspection documentation procedures, as required by Part V.D.4. of the permit. Inspections must occur at least once a week and within 24 hours of the end of a storm event that is ½ inch or greater (see attached form):

--

Identify and describe all sources of nonstormwater discharges as allowed in Part IV.A.3. of the permit. Flows from firefighting activities do not have to be listed or described.

--

This SWPPP must clearly identify, for each measure identified within the SWPPP, the contractor(s) or subcontractor(s) who will implement each measure. All contractor(s) and subcontractor(s) identified in the SWPPP must sign the following certification:

“I certify under penalty of law that I understand, and shall comply with, the terms and conditions of the State of Florida Generic Permit for Stormwater Discharge from Large and Small Construction Activities and this Stormwater Pollution Prevention Plan prepared thereunder.”

Name	Title	Company Name, Address, and Phone Number	Date

Stormwater Pollution Prevention Plan Inspection Report Form

Inspections must occur at least once a week and within 24 hours of the end of a storm event that is 1/2 inch or greater.

Project Name: _____ FDEP NPDES Stormwater Identification Number: FLR10 _____

Location	Rain data	Type of control (see below)	Date installed/modified	Current condition (see below)	Corrective action/other remarks

Condition Code:
 G = Good
 C = Needs to be cleaned
 M = Marginal, needs maintenance or replacement soon
 O = Other
 P = Poor, needs immediate maintenance or replacement

Control Type Codes

1. Silt fence	8. Pipe slope drain	16. Curb and gutter	23. Permanent seed/sod	30. Retention pond
2. Earth berms	9. Level spreaders	17. Paved road surface	24. Mulch	31. Waste disposal/ housekeeping
3. Structural diversion	10. Storm drain inlet protection	18. Rock outlet protection	25. Hay bales	32. Dam
4. Swale	11. Vegetative buffer strip	19. Reinforced soil-retaining system	26. Geotextile	33. Sandbag
5. Sediment trap	13. Retention pond	20. Gabion	27. Rip-rap	34. Other
6. Check dam	14. Construction entrance stabilization	21. Sediment basin	28. Tree protection	
7. Subsurface drain	15. Perimeter ditch	22. Temporary seed/sod	29. Detention pond	

Inspector Information:

Name _____ Qualification _____ Date _____
 The above signature also shall certify that this facility is in compliance with the Stormwater Pollution Prevention Plan and the State of Florida Generic Permit for Stormwater Discharge from Large and Small Construction Activities if there are no incidents of noncompliance identified above.

 "I certify under penalty of law that this document and all attachments were prepared under my direction or supervision in accordance with a system designed to ensure that qualified personnel properly gathered and evaluated the information submitted. Based on my inquiry of the person or persons who manage the system, or those persons directly responsible for gathering the information, the information submitted is, to the best of my knowledge and belief, true, accurate, and complete. I am aware that there are significant penalties for submitting false information, including the possibility of fine and imprisonment for knowing violations."

Name (Responsible Authority) _____ Date _____

Tab
Insert

CHAPTER 4: BEST MANAGEMENT PRACTICES FOR EROSION AND SEDIMENTATION CONTROL

- 4.1 Construction Sequencing
- 4.2 Pollution Source Controls on Construction Sites
- 4.3 Stabilized Construction Exit
- 4.4 Perimeter Controls
 - 4.4.1 Silt Fence
 - 4.4.2 Filter Sock
 - 4.4.3 Temporary Diversion Berm
 - 4.4.4 Temporary Fill Diversion
 - 4.4.5 Temporary Slope Drain
 - 4.4.6 Floating Turbidity Barrier
- 4.5 Storm Drain Inlet Protection
- 4.6 Temporary Sediment Trap
- 4.7 Temporary Sediment Basin
- 4.8 Temporary Check Dam

* * * * *

4.1 Construction Sequencing

Definition

Coordinating the construction schedule to minimize the amount of area disturbed at any one time and coordinating land clearing with the installation of erosion control measures.

Purpose

To minimize the amount of disturbed area, thus reducing erosion potential.

Condition where Practice Applies

This practice applies to all construction projects. The level of planning and management necessary to minimize erosion and control sedimentation adequately depends on the size, location, and complexity of the construction site.

Planning Considerations

The key to efficient and cost-effective erosion control is to plan construction activities in phases to reduce the erosion potential of the site. By clearing only the areas that are to be developed, only limited areas of land are disturbed, making it much easier to prevent and control erosion than if the entire site were exposed at once. Larger projects should be carried out in phases to minimize the area of exposed soil.

Before site disturbance occurs, perimeter controls, sediment traps, basins, and diversions should be in place to control runoff and capture sediments. Prioritize disturbed areas in the vicinity of waterbodies, wetlands, steep grades, long slopes, etc., for effective stabilization within seven days of disturbance. Graded areas that will not be worked on should be seeded and mulched immediately, rather than waiting until all project grading is done. A well-planned and well-maintained construction entrance with stabilized construction roads can prevent offsite sedimentation, keep sediments off roads, minimize complaints from neighbors, and reduce future expenses and aggravation.

Land-disturbing activities are best scheduled during periods of low precipitation. Generally, Florida's wet season occurs from May to November with a dry season from November to May. Check with your local water management district or FDOT office for more precise information in your area.

Specifications

The management of construction projects consists of three phases. *Phase I* is the initial installation of perimeter controls, sediment traps, basins, and diversions prior to site development. *Phase II* consists of an interim stormwater management plan in which components of the permanent stormwater management system are constructed and connected to the stormwater facilities as the site is developed. *Phase III* is the finished product and should perform as such.

Phase I

This is the first construction-related activity to occur on any site. The installation of initial controls shall be discussed at the preconstruction conference. The contractor and the inspector should understand the inspection and maintenance requirements of the specified BMPs, as well as their locations and proper installation procedures.

Offsite runoff should be diverted around the project if stabilized areas, adequate conveyance, and/or protected inlets are available. Sediment traps and basins should be built to receive the anticipated runoff and sediments. A temporary sediment basin in the location of the permanent stormwater facility makes efficient use of space and simplifies future tasks. Perimeter controls and diversions must be installed to keep sediments onsite and directed to the traps and basins. As clearing and grading progress, temporary seeding and mulching should follow immediately for areas that will not be worked for a period of seven days or more.

Phase II

During this interim phase of the project, the permanent stormwater management system is constructed in conjunction with the other construction activities. Before runoff is directed into it, the system must be properly stabilized. It must also be protected from sedimentation until the completion of the project. As the stormwater facilities are constructed, they should also be kept free of sediments. Special care must be taken if stormwater ponds are used as temporary sediment basins to ensure the complete removal of accumulated sediments that would reduce stormwater storage volume and cause premature clogging. If possible, design and excavate the sediment basin bottom 6 to 12 inches (15 to 30 centimeters [cm]) higher than the eventual pond bottom. Land disturbance should occur only in areas that are being actively worked. Graded areas

should be seeded and mulched immediately if they will not be worked for a period of 7 days or more.

A regular maintenance program should be in place to ensure that the BMPs are inspected and maintained by the contractor weekly and/or after significant rain events. Any failures should be analyzed to prevent recurrence. Substantial changes to the approved plan must be made or reviewed by the designer and approved by the appropriate regulatory agency.

Phase III

This is the completed project. The entire stormwater management system should be built according to the approved plans. Substantial deviations from the plan may require revisions by the design professional, reapproval by the regulatory agency, and/or reconstruction by the contractor. The system must also function as designed and in compliance with applicable regulatory criteria. Any previously unforeseen activities that could compromise the function or maintainability of the system should be addressed immediately.

4.2 Pollution Source Controls on Construction Sites

Definition

Minimizing nonpoint source pollution from construction sites through good management and "housekeeping" techniques.

Purpose

To reduce the availability of construction-related pollutants that can contaminate runoff water, or to retain pollutants and polluted water onsite.

Conditions Where Practice Applies

This practice applies to all construction projects. The level of planning and management necessary to control nonpoint source pollution adequately depends on the size and complexity of the construction site.

Planning Considerations

Construction activities, by their nature, create many sources of potential pollutants that can contaminate runoff and thus affect the quality of downstream receiving waters. Accelerated erosion and sedimentation caused by land-disturbing activities are the major pollution problems caused by construction.

There are, however, many other potential pollutants associated with construction activities, such as gasoline, oils, grease, paints, cements, and solvents, to name only a few. Even relatively nontoxic materials such as paper and cardboard are potential pollutants when they are washed into streams and lakes.

The best way to prevent nonpoint source pollution on construction sites is to use good housekeeping practices, which usually entail simply maintaining the site in a neat and orderly condition. Specific practices should be employed to retain runoff and to deal with toxic substances and materials. An overall plan for the control of nonpoint source pollution is advisable so that control measures can be specified and implemented effectively.

The following elements should be considered in nonpoint source pollution control planning on a construction site:

1. Erosion and Sediment Controls

Practices that minimize erosion and retain sediment onsite are also effective in controlling many other nonpoint source pollutants associated with construction activities. The development and implementation of a good erosion and sediment control plan is a key factor in controlling nonpoint source pollutants other than sediment on a construction site.

2. Vehicle Wash Areas

Vehicles such as dump trucks, concrete trucks, and other construction equipment should **NOT** be washed at locations where the runoff will flow directly into a waterbody or stormwater conveyance system. Special areas should be designated for washing

vehicles. Concrete washout areas should be located where the runoff can be collected and removed from the site or collected for drying and reused on site. Concrete washout areas may be constructed onsite by digging a pit and lining it with plastic. Manufactured products and waste disposal companies also are available.



3. Equipment Maintenance and Repair

The maintenance and repair of construction machinery and equipment should be confined to areas specifically designated for that purpose. Such areas should be located and designed so that oils, gasoline, grease, solvents, and other potential pollutants cannot be washed directly into receiving streams, stormwater conveyance systems, or existing and potential well fields. These areas should have adequate waste disposal receptacles for liquid and solid wastes. Maintenance areas should be inspected and cleaned daily.

On a construction site where designated equipment maintenance areas are not feasible, exceptional care should be taken during each individual repair or maintenance operation to prevent potential pollutants from being washed into streams or conveyance systems. Temporary waste disposal receptacles should be provided and emptied as required.

4. Waste Collection and Disposal

A plan should be formulated for collecting and disposing of waste materials on a construction site. It should designate locations for trash and waste receptacles and establish a specific collection schedule. Methods for the ultimate disposal of waste should be specified and carried out according to applicable local and state health and safety regulations. Special provisions should be made for the collection, storage, and disposal of liquid wastes and toxic or hazardous materials.

Receptacles and other waste collection areas should be kept neat and orderly to the extent possible. Trash cans should have lids and dumpsters should have covers to prevent rainwater from entering. Waste should not be allowed to overflow its container or accumulate for excessively long periods. Trash collection points should be located where they are least likely to be affected by concentrated stormwater runoff.

5. Demolition Areas

Demolition projects usually generate large amounts of dust with significant concentrations of heavy metals and other toxic pollutants. Dust control techniques

should be used to limit the transport of airborne pollutants. However, water or slurry used to control dust should be retained onsite and should not be allowed to run directly into watercourses or stormwater conveyance systems.

6. Storage of Construction Materials, Chemicals, Etc.

Sites where chemicals, cements, solvents, paints, or other potential water pollutants are to be stored should be isolated in areas where they will not cause runoff pollution. Toxic chemicals and materials, such as pesticides, paints, and acids, should be stored according to the manufacturers' guidelines. Overuse should be avoided, and great care should be taken to prevent accidental spillage. Containers should **NEVER** be washed in or near flowing streams or stormwater conveyance systems.



Ground water resources should be protected from leaching by placing a plastic mat, tarpaper, or other impervious materials on any areas where toxic liquids are to be opened and stored. Portable storage units are also commercially available for material storage and can be locked at the end of the day.

7. Stockpiles

Soil stockpiles should be protected or adequately covered from stormwater during construction. Simple protection measures include silt fencing or a trench around the base of the stockpile. A tarp or temporary seeding also can provide adequate cover for a soil stockpile. Stockpiles should not be placed near the perimeter of the site, near a waterbody or storm drain inlet, or within 10 feet of an infiltration/exfiltration system.

4.3 Stabilized Construction Exit



Definition

A stabilized pad located at points where vehicles enter and leave a construction site.

Purpose

To reduce the amount of sediment transported onto public roads by motor vehicles or runoff.

Conditions Where Practice Applies

Wherever traffic will be leaving a construction site and moving directly onto a public road or other paved area.

Planning Considerations

Construction entrances provide an area where mud can be removed from construction vehicle tires before they enter a public road. If the action of the vehicle traveling over the stabilized pad is not sufficient to remove most of the mud, then the tires must be washed before the vehicle enters a public road. If tire washing is provided, provisions must be made to intercept the wash water and trap the sediment before it is carried offsite. Construction entrances should be used in conjunction with the stabilization of construction roads to reduce the amount of mud picked up by construction vehicles.

Design Criteria

Aggregate Size

If stone is utilized, FDOT No. 1 Coarse Aggregate, 1½ to 3½ inch (4 to 9 cm) stone is suggested. Wood chips may be used for single-family residential construction, provided that they can be prevented from floating away during a storm event. Manufactured products also are available to prevent or reduce the amount of sediment tracked onto

roadways. If a stabilized exit is not sufficient, street sweeping can be provided as an additional measure.

Dimensions

If stone is used, then the aggregate layer must be at least 6 inches (15 cm) thick. It must extend the **FULL WIDTH** of the vehicular ingress and egress area. The length of the entrance must be at least 50 feet (20 m). The exit should widen at its connection to the roadway to accommodate the turning radius of large trucks (see **Figure 4.3a**).

Washing

If conditions on the site are such that most of the mud is not removed by the vehicles traveling over the stone, then the vehicle tires must be washed before entering a public road. Wash water must be carried away from the entrance to a settling area to remove sediment (see **Figure 4.3b**). A wash rack may also be used to make washing more convenient and effective (see **Figure 4.3c**).

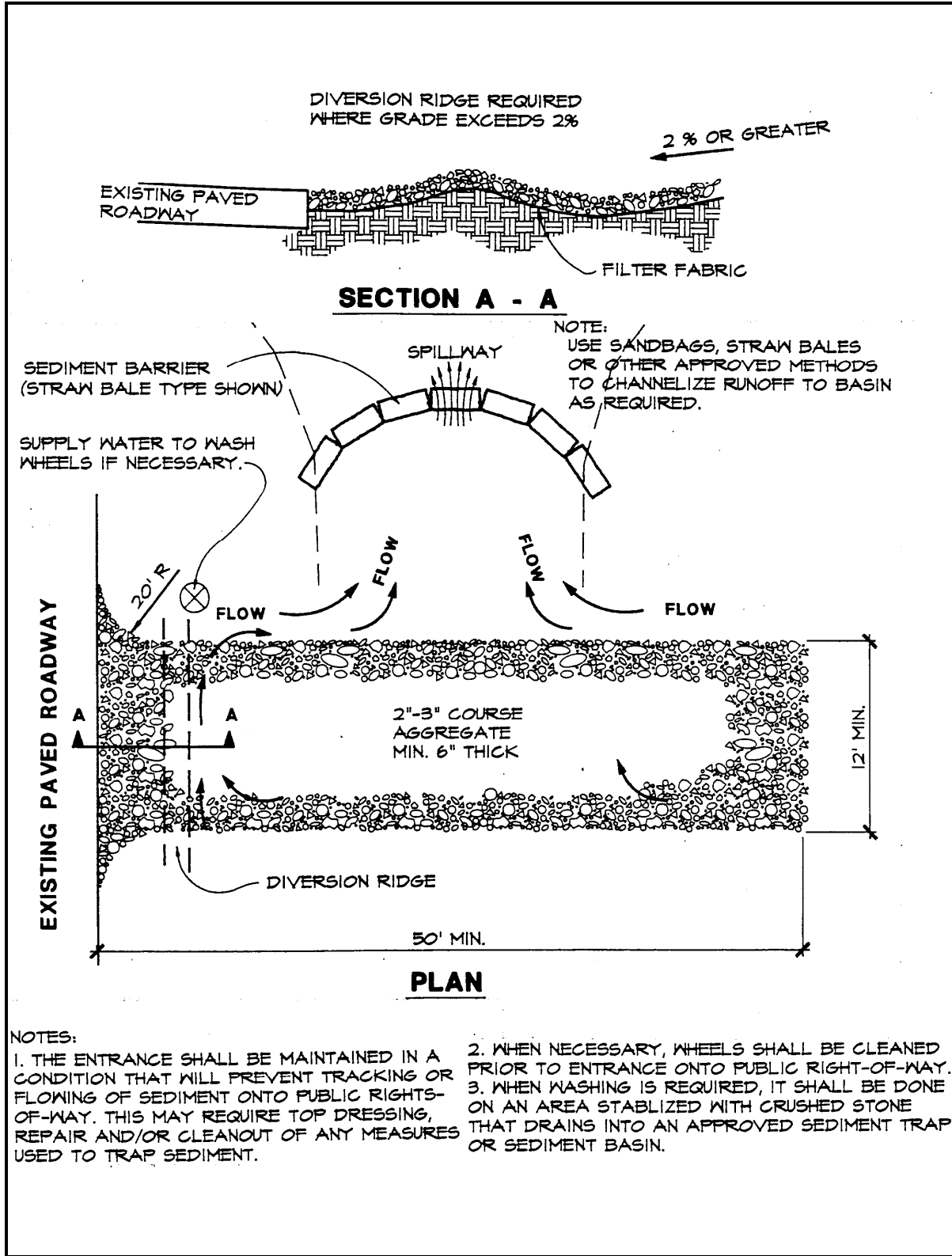

Figure 4.3a. Temporary Gravel Construction Entrance

Source: Erosion Draw

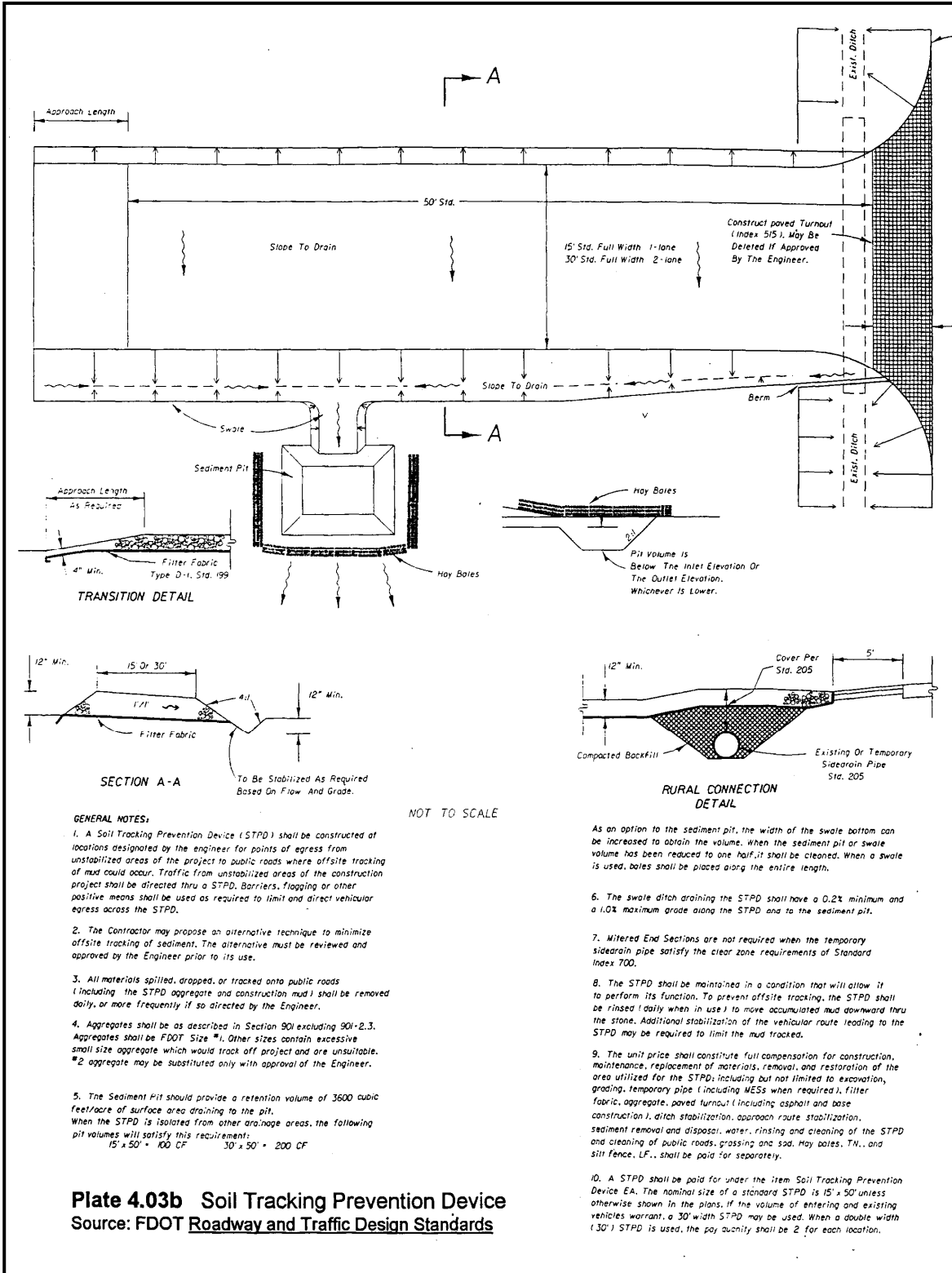

Figure 4.3b. Soil Tracking Prevention Device

Source: FDOT Roadway and Traffic Design Standards

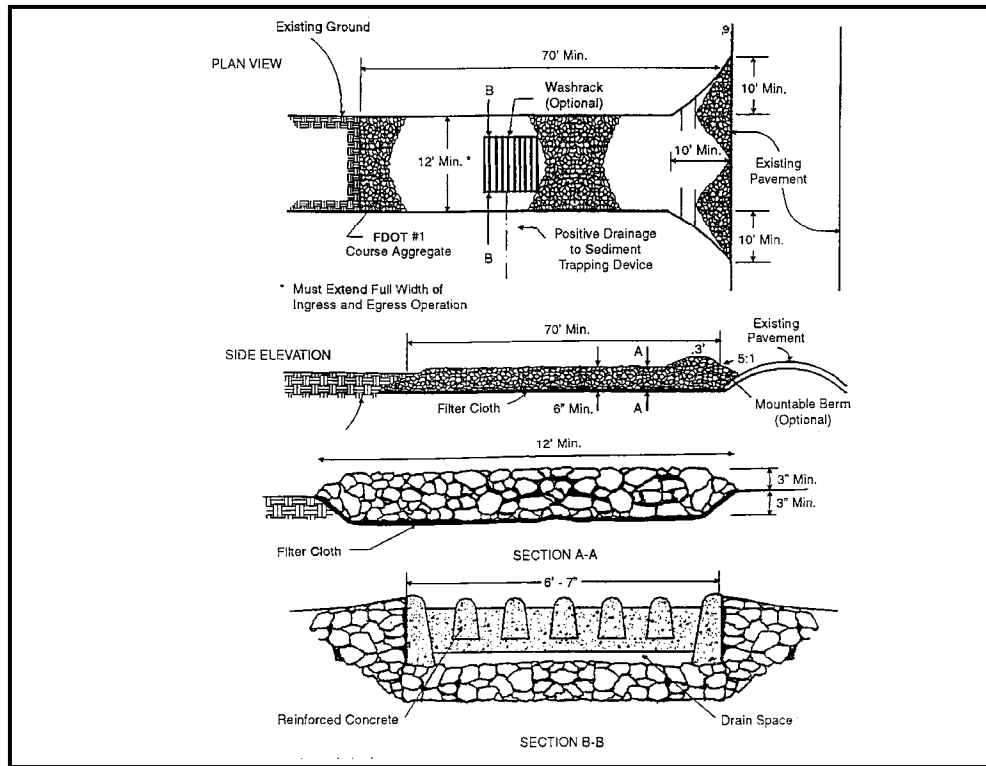

Figure 4.3c. Construction Entrance with Wash Rack

Source: 1983 Maryland Standards for Soil Erosion and Sediment Control

Location

The entrance should be located to provide for maximum utility by all construction vehicles.

Construction Specifications

The entrance area should be cleared of all vegetation, roots, and other objectionable material. A geotextile should be laid down to improve stability and simplify maintenance when gravel is used. The gravel shall then be placed over the geotextile to the specified dimensions.



Maintenance

The stabilized construction exit shall be maintained in a condition that will prevent the tracking or flow of mud onto public rights of way. This may require periodic maintenance as conditions demand, and the repair and/or cleanout of any structures used to trap sediments. All materials spilled, dropped, washed, or tracked from vehicles onto roadways or into storm drains must be removed immediately. Look for signs of trucks and trailered equipment "cutting corners" where the construction exit meets the roadway. Sweep the paved road as needed.

4.4 Perimeter Controls

Overview

Perimeter controls intercept and detain small amounts of sediment from disturbed areas during construction operations. These measures include silt fences, filter socks, temporary diversion berms, temporary fill diversions, temporary slope drains, and floating turbidity barriers. They are the last line of defense and one of the most visible and maintenance-intensive BMPs on an active construction site.

These measures reduce the potential for sediment to enter offsite areas such as roadways, storm drains, or adjacent properties. They are used under the following conditions:

- 1. Below disturbed areas where erosion would occur in the form of sheet and rill erosion.*
- 2. Where the size of the drainage area is no more than ¼ acre per 100 feet of perimeter control measure; the maximum slope length behind the barrier is 100 feet; and the maximum gradient behind the barrier is 50% (2:1).*

These measures should be installed before clearing and grading activities begin. They typically remain installed and maintained until the contributing drainage area is stabilized.

4.4.1 Silt Fence

Definition

A temporary sediment barrier consisting of a filter fabric stretched across and attached to supporting posts and entrenched. Some silt fence is wire reinforced for support.



Purpose

The purpose of a silt fence is to slow the velocity of water and retain sediment onsite.

Conditions Where Practice Applies

A silt fence should only be installed for sediment capture under sheetflow conditions. It should not be installed for channel flow conditions or in live streams or waterways.

Planning Considerations

Silt fences can trap a much higher percentage of suspended sediments than straw bales and are preferable to straw barriers in many cases. The most effective application is to install two parallel silt fences spaced a minimum of three feet apart. The installation and maintenance methods outlined here can improve performance.

Silt fences composed of a wire support fence with attached synthetic filter fabric slow the flow rate significantly and have high filtering efficiency. Both woven and nonwoven synthetic fabrics are commercially available. The woven fabrics are generally stronger than the nonwoven fabrics. When tested under acid and alkaline water conditions, most of the woven fabrics increase in strength. There is a variety of reactions among the nonwoven fabrics. The same is true of testing under extensive ultraviolet radiation. Permeability rates vary regardless of fabric type. While all of the fabrics demonstrate high filtering efficiencies for sandy sediments, there is considerable variation among both woven and nonwoven fabrics when filtering finer silt and clay particles.

Design Criteria

- 1. No formal design is required for many small projects and for minor and incidental applications.*
- 2. Silt fences shall have an expected usable life of six months. They are applicable around perimeters and stockpiles, and at temporary locations where continuous construction changes the earth contour and runoff characteristics.*
- 3. Silt fences have limited applicability to situations in which only sheet or overland flows are expected. They normally cannot filter the volumes of water generated by channel flows, and many fabrics do not have sufficient structural strength to support the weight of water ponded behind the fence line.*

Construction Specifications

Materials

1. *Synthetic filter fabric shall be a pervious sheet of propylene, nylon, polyester, or polyethylene yarn. It shall contain ultraviolet ray inhibitors and stabilizers to provide a minimum of 6 months of expected usable construction life at a temperature range of 0°F. to 120°F. (-17°C. to 49°C.).*
2. *The stakes for a silt fence shall be 1 x 2 inches (2.5 x 5 cm) wood (preferred), or equivalent metal with a minimum length of 3 feet (90 cm).*
3. *Wire fence reinforcement for silt fences using standard-strength filter cloth shall be a minimum of 36 inches (90 cm) in height, shall be a minimum of 14 gauge, and shall have a maximum mesh spacing of 6 inches (15 cm).*

Sheetflow Application: Silt Fence

This sediment barrier uses standard-strength or extra-strength synthetic filter fabrics. It is designed for situations in which only sheet or overland flows are expected (see **Figures 4.4a** and **4.4b**):

1. *The height of a silt fence shall not exceed 36 inches (90 cm). Higher fences may impound volumes of water sufficient to cause failure of the structure.*
2. *The filter fabric shall be purchased in a continuous roll cut to the length of the barrier to avoid the use of joints. When joints are necessary, filter cloth shall be spliced as described in Item 8 below.*
3. *Posts shall be spaced a maximum of 10 feet (3 m) apart at the barrier location and driven securely into the ground a minimum of 12 inches (30 cm). When extra-strength fabric is used without the wire support fence, post spacing shall not exceed 6 feet (1.8 m).*
4. *A trench shall be excavated approximately 4 inches (10 cm) wide and 4 inches (10 cm) deep along the line of posts and upslope from the barrier.*
5. *When standard-strength filter fabric is used, a wire mesh support fence shall be fastened securely to the upslope side of the posts using heavy-duty wire staples at least 1 inch (25 mm) long, tie wires, or hog rings. The wire shall extend into the trench a minimum of 2 inches (5 cm) and shall not extend more than 36 inches (90 cm) above the original ground surface.*
6. *The standard-strength filter fabric shall be stapled or wired to the fence, and 8 inches (20 cm) of the fabric shall be extended into the trench. The fabric shall not extend more than 36 inches (90 cm) above the original ground surface.*
7. *When extra-strength filter fabric and closer post spacing are used, the wire mesh support fence may be eliminated. In this case, the filter fabric is stapled or wired directly to the posts with all other provisions of Item 6 applying.*

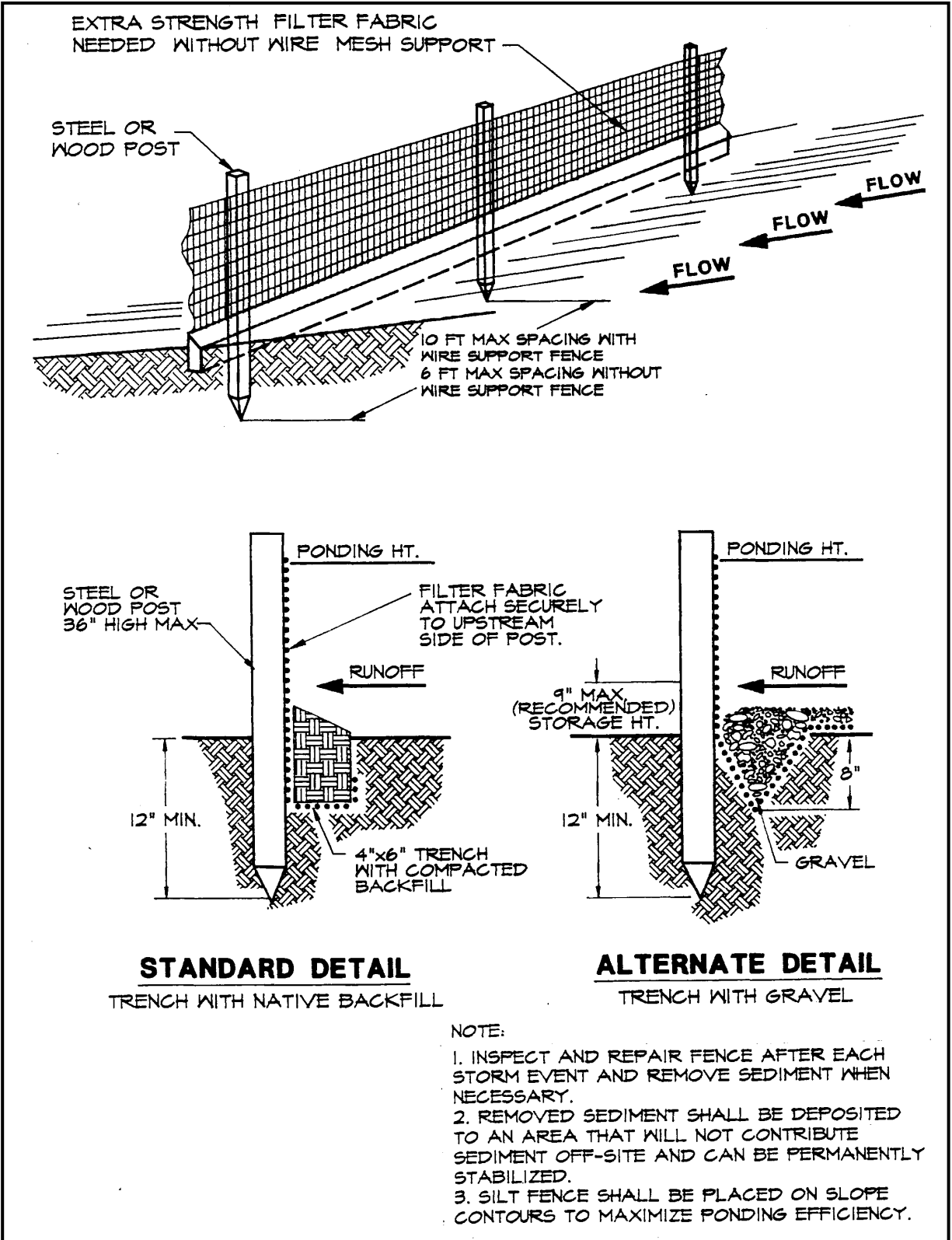

Figure 4.4a. Silt Fence

Source: Erosion Draw

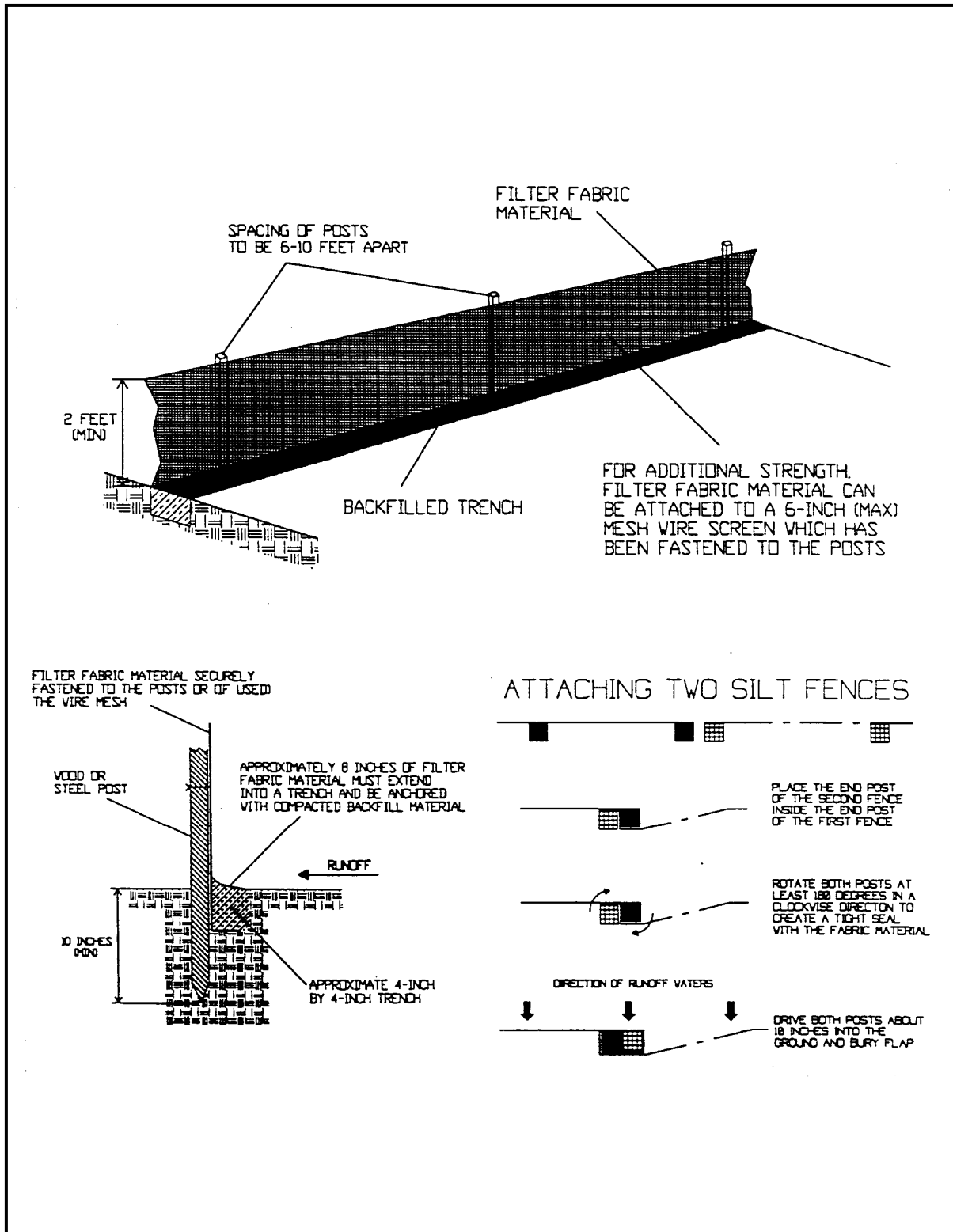

Figure 4.4b. Installing a Filter Fabric Silt Fence

Source: HydroDynamics, Inc.

8. *When attaching 2 silt fences together, place the end post of the second fence inside the end post of the first fence. Rotate both posts at least 180 degrees in a clockwise direction to create a tight seal with the filter fabric. Drive both posts into the ground and bury the flap (see **Figure 4.4b**).*
9. *The trench shall be backfilled and the soil compacted over the filter fabric.*
10. *The most effective application consists of a double row of silt fences spaced a minimum of 3 feet apart, so that if the first row collapses it will not fall on the second row. Wire or synthetic mesh may be used to reinforce the first row (see **Figure 4.4c**).*
11. *When used to control sediments from a steep slope, silt fences should be placed away from the toe of the slope for increased holding capacity (see **Figure 4.4d**).*
12. *Silt fences shall be removed when they have served their useful purpose, but not before the upslope area has been permanently stabilized.*

Maintenance

1. *Silt fences shall be inspected within 24 hours after each ½-inch rainfall event and at least once a week. Any required repairs shall be made immediately.*
2. *Should the fabric on a silt fence decompose or become ineffective before the end of the expected usable life and the barrier is still necessary, the fabric shall be replaced promptly.*
3. *Sediment deposits should be removed when deposits reach approximately one-half the height of the barrier.*
4. *Any sediment deposits remaining in place after the silt fence is no longer required shall be dressed to conform with the existing grade, prepared, and seeded.*

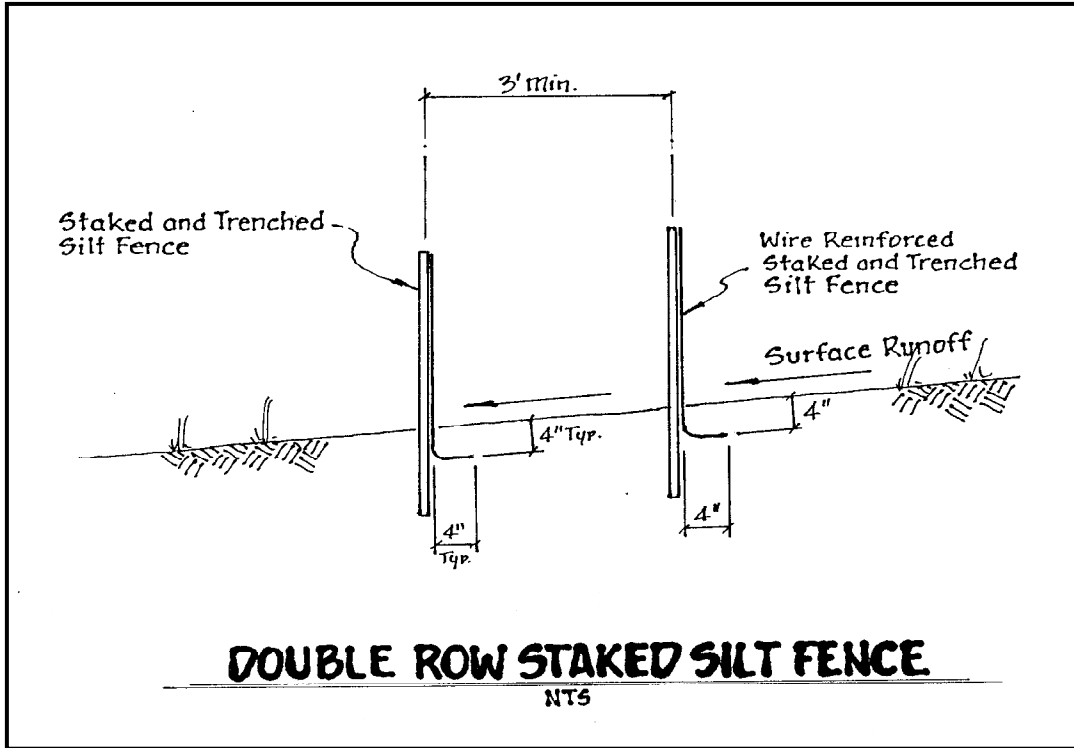

Figure 4.4c. Double Row Staked Silt Fence

Source: Reedy Creek Improvement District

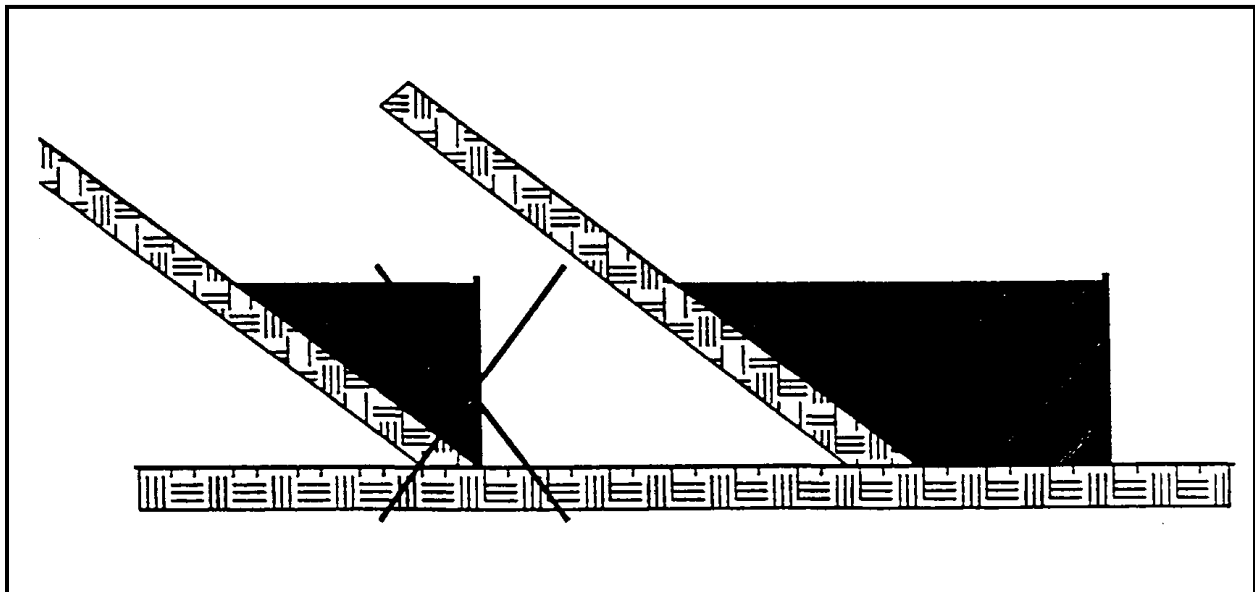

Figure 4.4d. Proper Placement of a Silt Fence at the Toe of a Slope

Source: HydroDynamics, Inc.

4.4.2 Filter Sock

Definition

A filter sock is a three-dimensional, tubular sediment control and stormwater runoff filtration device, typically used for the perimeter control of sediment and soluble pollutants.

Purposes

- 1. To trap sediment and soluble pollutants by filtering runoff water as it passes through the fiber matrix, allowing the deposition of suspended solids.*
- 2. To decrease the velocity of sheetflows and low- to moderate-level channel flows.*



Conditions Where Practice Applies

- 1. Site perimeters.*
- 2. Below disturbed areas where erosion would occur in the form of sheet and rill erosion.*
- 3. Above and below exposed and erodible slopes.*
- 4. Around curb and drop inlets.*
- 5. Along the toe of stream and channel banks.*
- 6. Where the size of the drainage area is no more than ¼ acre per 100 feet (1.3 ha/100 m) of silt fence length, the maximum slope length behind the barrier is 100 feet (30 m), and the maximum gradient behind the barrier is 50% (2:1).*
- 7. Around sensitive trees where the trenching of a silt fence is not beneficial for tree survival or may unnecessarily disturb established vegetation.*
- 8. In areas where it is necessary to minimize the obstruction of wildlife movement and migration.*

Planning Considerations

A filter sock can be easily implemented as a BMP within a treatment train onsite. The filter sock is installed on top of the soil and does not require soil disturbance for installation and removal. A filter sock contains organic material that can be direct seeded at the time of application to provide greater stability and filtration capacity once vegetation is established. The mesh socks are biodegradable or photodegradable and can be left onsite after construction activity. Filter sock performance depends on ground surface contact and may not be suitable for an extremely bumpy or rocky land surface.

Design Criteria

1. *No formal design is required for many small projects and for minor and incidental applications.*
2. *Filter socks shall have an expected usable life of 9 months. They are applicable in ditch lines, around drop inlets, and at temporary locations where continuous construction changes the earth contour and runoff characteristics, and where low or moderate flows (not exceeding 1 cubic foot per second [cfs]) (0.03 cubic meters per second [m^3/sec]) are expected.*
3. *Filter socks also are applicable where sheet or overland flows are expected. They can be used in channel flow applications to slow the water down and allow time for sediment to settle out of suspension.*

Construction Specifications

Materials

1. *A synthetic filter sock shall be a photodegradable or biodegradable mesh netting material providing a minimum of 9 months of expected usable life at a temperature range of 0°F. to 120°F. (-17°C. to 49°C.).*
2. *The media within the filter sock shall contain composted material suitable for removing solids and soluble pollutants from stormwater runoff.*
3. *Socks are available in 9-inch, 12-inch, 18-inch, and 24-inch diameters for a variety of applications and may be stacked for increased storage capacity.*
4. *Posts for the filter sock shall be 2 x 2 inches (2.5 x 5 cm) wood (preferred), or equivalent metal with a maximum height of 3 feet.*

Installation

1. *Posts shall be spaced a maximum of 10 feet (3 m) apart at the barrier location and driven securely into the ground a minimum of 8 inches (30 cm) in clay soils or 12 inches for sand soils. For use on pavement, heavy concrete blocks shall be used behind the filter socks for stabilization.*
2. *When joining two filter socks together, overlap the two sections by about a foot. Drive a stake into the ground through each filter sock.*
3. *Filter socks shall be removed or cut open when they have served their useful purpose, but not before the upslope area is permanently stabilized.*
4. *Filter socks shall not be used in perennial, ephemeral, or intermittent streams.*

Maintenance

1. *Filter socks shall be inspected at least once per week and within 24 hours of each ½ inch or greater rainfall event. Replacements and repairs must be made within a maximum of 7 days.*
2. *Sediment deposits should be removed when deposits reach approximately one-half the height of the barrier.*

4.4.3 Temporary Diversion Berm

Definition

A temporary ridge of compacted soil located at the top or base of a sloping, disturbed area.

Purposes

- 1. To divert storm runoff from higher drainage areas away from unprotected slopes to a stabilized outlet.*
- 2. To divert sediment-laden runoff from a disturbed area to a sediment-trapping facility.*



Condition Where Practice Applies

Wherever stormwater runoff must be temporarily diverted to protect disturbed slopes or retain sediments onsite during construction. These structures generally have a life expectancy of 18 months or less.

Planning Considerations

A temporary diversion berm is intended to divert overland sheetflow to a stabilized outlet or a sediment-trapping facility during the establishment of permanent stabilization on sloping, disturbed areas. When used at the top of a slope, the structure protects exposed slopes by keeping upland runoff away. When used at the base of a slope, the structure protects adjacent and downstream areas by diverting sediment-laden runoff to a sediment-trapping facility.

If the berm is going to remain in place for longer than 30 days, it is very important that it be established with temporary or permanent vegetation. The slope behind the berm is also an important consideration. The berm must have a positive grade to ensure drainage, but if the slope is too great, precautions must be taken to prevent erosion from high-velocity flow behind the berm.

This practice is considered economical because it uses material available onsite and can usually be constructed with equipment needed for site grading. The useful life of the practice can be extended by stabilizing the berm with vegetation.

As specified here, this practice is intended to be temporary. However, with more stringent design criteria, it can be made permanent in accordance with **DIVERSION (Chapter 6)**.

Design Criteria

No formal design is required. The following criteria must be met:

Drainage Area

The maximum allowable drainage area is 5 acres (2 ha).

Dimensions

The minimum allowable height measured from the upslope side of the berm is 18 inches (45 cm). The top width shall be a minimum of 2 feet (60 cm) with a minimum base width of 4½ feet (1.4 m) (see **Figure 4.4e**).

Side Slopes

3:1 or flatter.

Grade

The channel behind the berm shall have a positive grade to a stabilized outlet. If the channel slope is less than or equal to 2%, no stabilization is usually required. If the slope is greater than 2%, the channel shall be stabilized in accordance with **STORMWATER CONVEYANCE CHANNEL (Chapter 6)**.

Outlet

- 1. The diverted runoff, if free of sediment, must be released through a stabilized outlet or channel.*
- 2. Sediment-laden runoff must be diverted and released through a sediment-trapping facility.*

Construction Specifications

- 1. Whenever feasible, the berm should be built before construction begins on the project.*
- 2. The berm should be adequately compacted to prevent failure.*
- 3. Temporary or permanent seeding and mulch shall be applied to the berm within 15 days of construction.*
- 4. The berm should be located to minimize damage by construction operations and traffic.*

Maintenance

The berm shall be inspected after every storm and repairs made to the berm, flow channel, and outlet, as necessary. Approximately once a week, whether a storm has occurred or not, the berm shall be inspected and repairs made if needed. Damage caused by construction traffic or other activity must be repaired before the end of each working day.

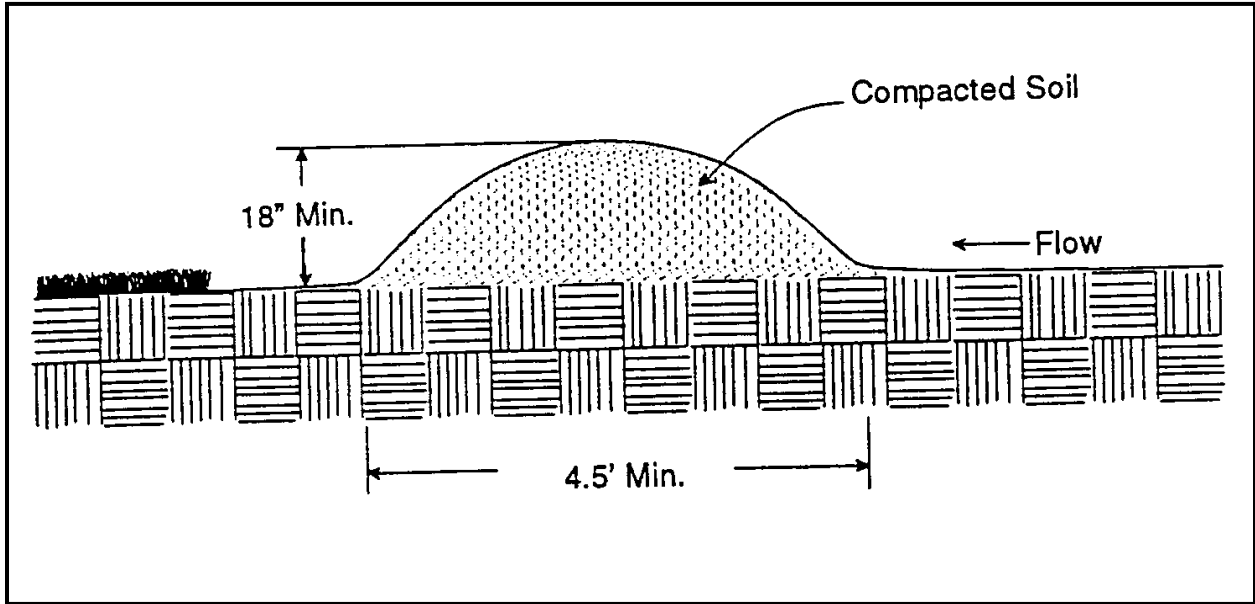

Figure 4.4e. Temporary Diversion Berm

Source: Virginia Division of Soil and Water Conservation (DSWC)

4.4.4 Temporary Fill Diversion

Definition

A channel with a supporting ridge on the lower side cut along the top of an active earth fill.

Purpose

To divert storm runoff away from the unprotected slope of the fill to a stabilized outlet or sediment-trapping facility

Conditions Where Practice Applies

Where the drainage area at the top of an active earth fill slopes toward the exposed slope and where continuous fill operations make the use of a **DIVERSION (Chapter 6)** unfeasible. This temporary structure should remain in place for less than one week.

Planning Considerations

One important principle of erosion and sediment control is to keep stormwater runoff away from exposed slopes. This is often accomplished by installing a berm, diversion, or paved ditch at the top of a slope to carry the runoff away from the slope to a stabilized outlet or downdrain. In general, these measures are installed after the final grade has been reached. On cuts, the measures may be installed at the beginning, since the work proceeds from the top and the measures have little chance of being covered or damaged. On fills, the work proceeds from the bottom to the top and the elevation changes daily. It is therefore not feasible to construct a compacted berm or permanent diversion that may be covered by the next day's activity.

The temporary fill diversion is intended to provide some slope protection on a daily basis until final elevations are reached and a more permanent measure can be constructed. This measure can be carried out using a motor grader or one of the smaller bulldozers. To shape the diversion, the piece of machinery used may run near the edge of the fill with its blade tilted to form the channel, as described in **Figure 4.4f**. This work should be done at the end of the working day and should provide a channel with a berm on the lower side to protect the slope. Wherever possible, the temporary diversion should be sloped to direct water to a stabilized outlet. If the runoff is diverted over the fill itself, the practice may cause more problems than it solves by concentrating water at a single point.

Good timing is essential to fill construction. The filling operation should be completed as quickly as possible and the permanent slope protection measures and slope stabilization measures installed as soon after completion as possible. With quick and proper construction, the developer or contractor will save both time and money in building, repairing, and stabilizing the fill area. The longer the period for construction and stabilization, the more prone the fill operation is to erosion damage. Repairing the damage adds time and expense to the project.

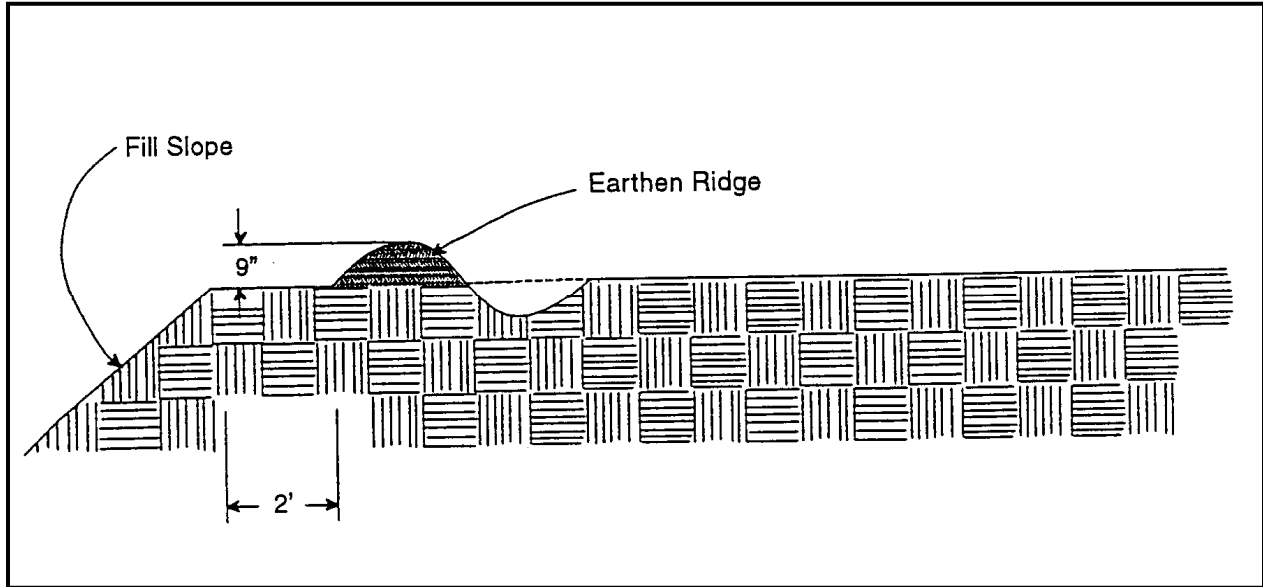

Figure 4.4f. Temporary Fill Diversion

Source: Virginia DSWC

Design Criteria

No formal design is required. The following criteria shall be met:

Drainage Area

The maximum allowable drainage area is 5 acres (2 ha).

Height

The minimum height of the supporting ridge shall be 9 inches (23 cm) (see **Figure 4.4f**).

Grade

The channel shall have a positive grade to a stabilized outlet.

Outlet

The diverted runoff should be released through a stabilized outlet, slope drain, or sediment-trapping measure.

Construction Specifications

1. *The diversion shall be constructed at the top of the fill at the end of each workday as needed.*
2. *The diversion shall be located at least 2 feet (60 cm) inside the top edge of the fill (see **Figure 4.4f**).*
3. *The supporting ridge of the lower side shall be constructed with a uniform height along its entire length.*

Maintenance

Since the diversion is temporary and under most situations will be covered the next workday, the maintenance required should be low. If it is to remain in use for more than one day, the structure must be inspected at the end of each workday and repairs made if needed. The contractor should avoid placing any material over the structure while it is in use. Construction traffic should not be permitted to cross the diversion.

4.4.5 Temporary Slope Drain

Definition

A flexible tubing or conduit extending from the top to the bottom of a cut or fill slope.

Purpose

To temporarily convey concentrated stormwater runoff safely down the face of a cut or fill slope without causing erosion problems on or below the slope.



Conditions Where Practice Applies

On cut or fill slopes before permanent stormwater drainage structures are installed.

Planning Considerations

There is often a significant lag between the completion of a cut or fill slope and the installation of a permanent drainage system. During this period, the slope is usually not stabilized and is particularly vulnerable to erosion. This situation also occurs on slope construction that is temporarily delayed before final grade is reached. Temporary slope drains can provide valuable protection of exposed slopes until permanent drainage structures can be installed.

When used in conjunction with diversion berms, temporary slope drains can be used to convey stormwater from the entire drainage area above a slope to the base of the slope without erosion. It is very important that these temporary structures be installed properly, since their failure will often result in severe gully erosion. The entrance section must be securely entrenched, all connections must be watertight, and the conduit must be staked securely.

Design Criteria

Drainage Area

The maximum allowable drainage area per drain is 5 acres (2 ha).

Flexible Conduit

- 1. The slope drain shall consist of heavy-duty flexible material designed for this purpose. The diameter of the slope drain shall be equal over its entire length. Reinforced hold-down grommets shall be spaced at 10 foot (3 m) maximum intervals.*
- 2. Slope drains shall be sized according to the specifications in **Table 4.1**.*

Overside Drain

For small flows and/or short slopes, an open top chute may be used in place of a pipe (see **Figure 4.4g**).

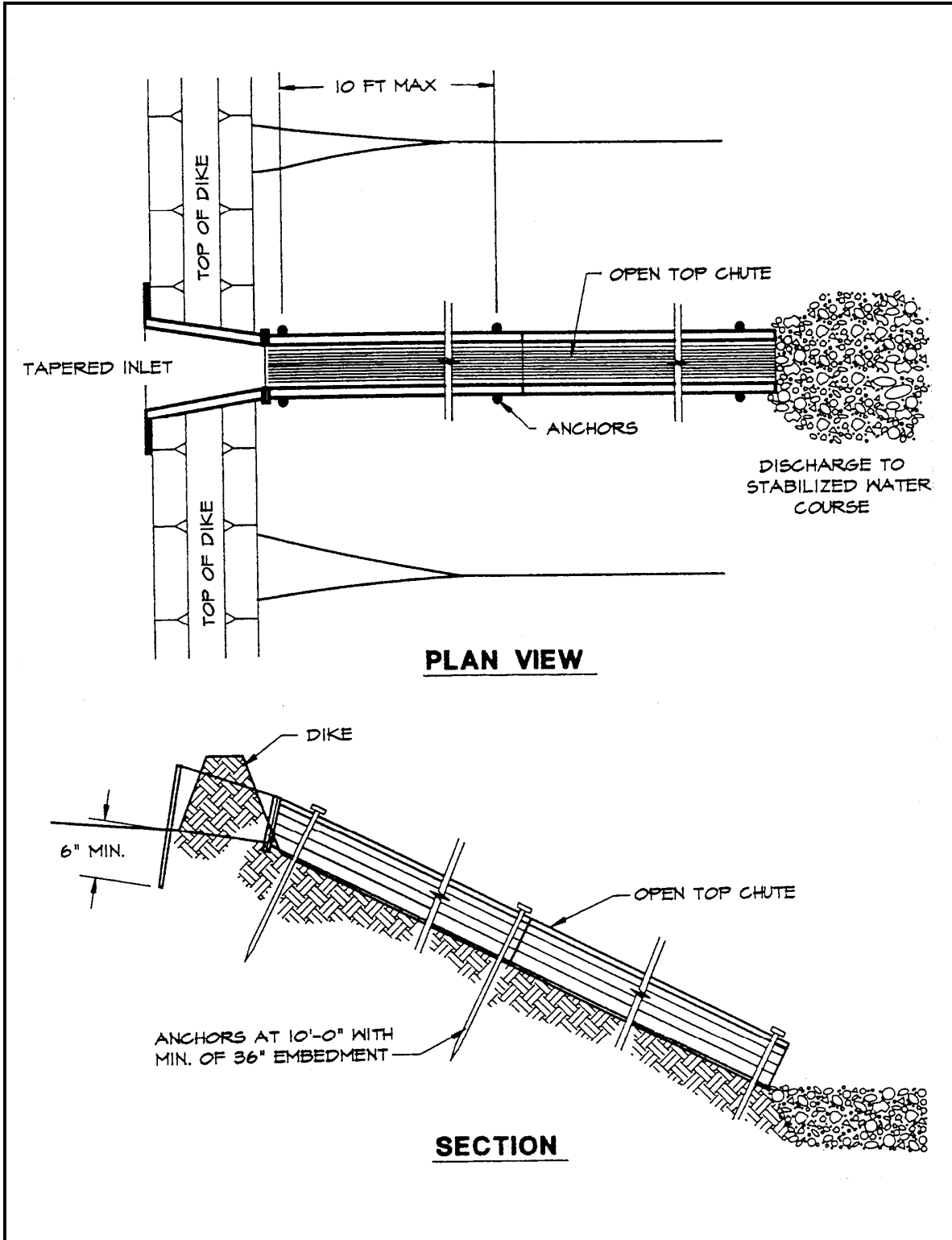

Figure 4.4g. Oversedrain

Source: Erosion Draw

Table 4.1. Size of Slope Drain

Maximum Drainage Area (acres)	Pipe Diameter (inches)
0.5	12
1.5	18
2.5	21
3.5	24
5.0	30

Entrance Sections

The entrance to the slope drain shall consist of a standard FDOT "Flared End-Section for Metal Pipe Culverts." Extension collars shall consist of 12 inch (30 cm) long corrugated metal pipe. Watertight fittings shall be provided (see **Figures 4.4h** and **4.4i**).

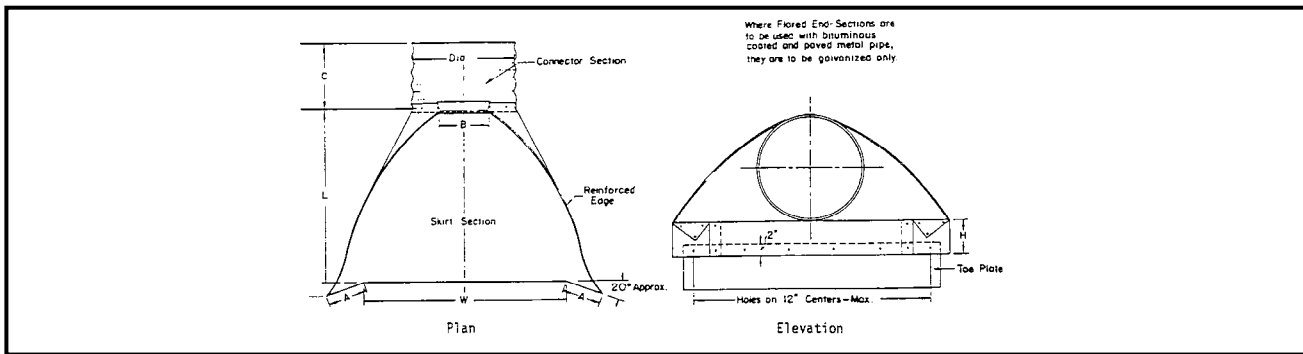

Figure 4.4h. Flared End Section Schematic

Source: Virginia Department of Highways and Transportation (DH&T) Road Designs and Standards

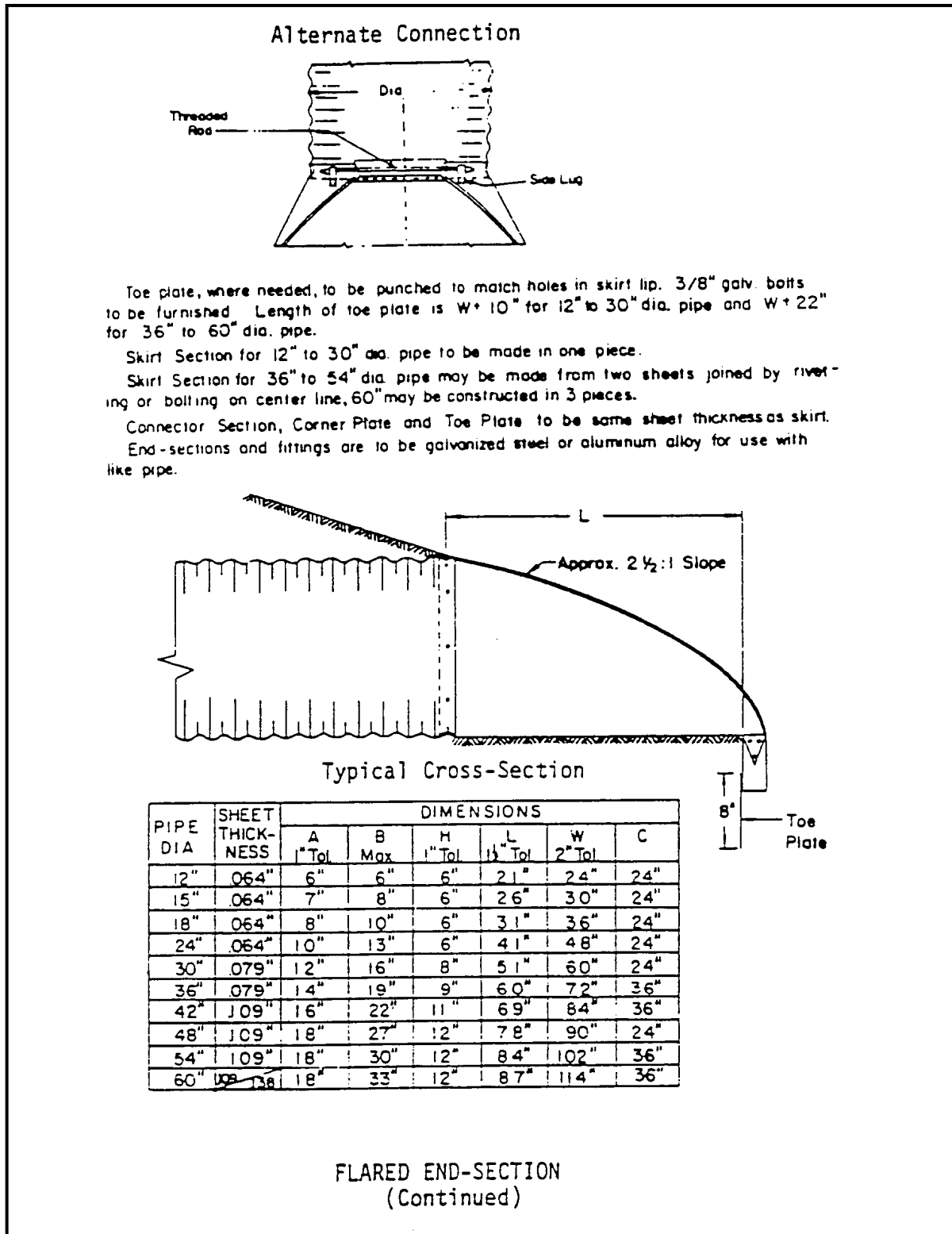

Figure 4.4i. Flared End Section Specifications

Source: Virginia DH&T Road Designs and Standards

Berm Design

1. An earthen berm shall be used to direct stormwater runoff into the temporary slope drain and shall be constructed according to **DIVERSION (Chapter 6)** (see **Figure 4.4j**).
2. The height of the berm at the center line of the inlet shall be equal to the diameter of the pipe (D) plus 6 inches (15 cm). Where the berm height is greater than 18 inches (45 cm) at the inlet, it shall be sloped at the rate of 3:1 or flatter to connect with the remainder of the berm (see **Figure 4.4j**).

Outlet Protection

The outlet of the slope drain shall be protected from erosion according to **OUTLET PROTECTION (Chapter 6)** (see **Figure 4.4k**).

Construction Specifications

1. The measure shall be placed on undisturbed soil or well-compacted fill.
2. The entrance section shall slope toward the slope drain at the minimum rate of $\frac{1}{2}$ inch per foot (4 cm/m).
3. The soil around and under the entrance section shall be hand-tamped in 8 inch (20 cm) lifts to the top of the berm to prevent piping failure around the inlet.
4. The slope drain shall be securely staked to the slope at the grommets provided.
5. The slope drain sections shall be securely fastened together and have watertight fittings.

Maintenance

The slope drain structure shall be inspected weekly and after every storm, and shall have repairs made if necessary. The contractor should avoid the placement of any material on and prevent construction traffic across the slope drain.

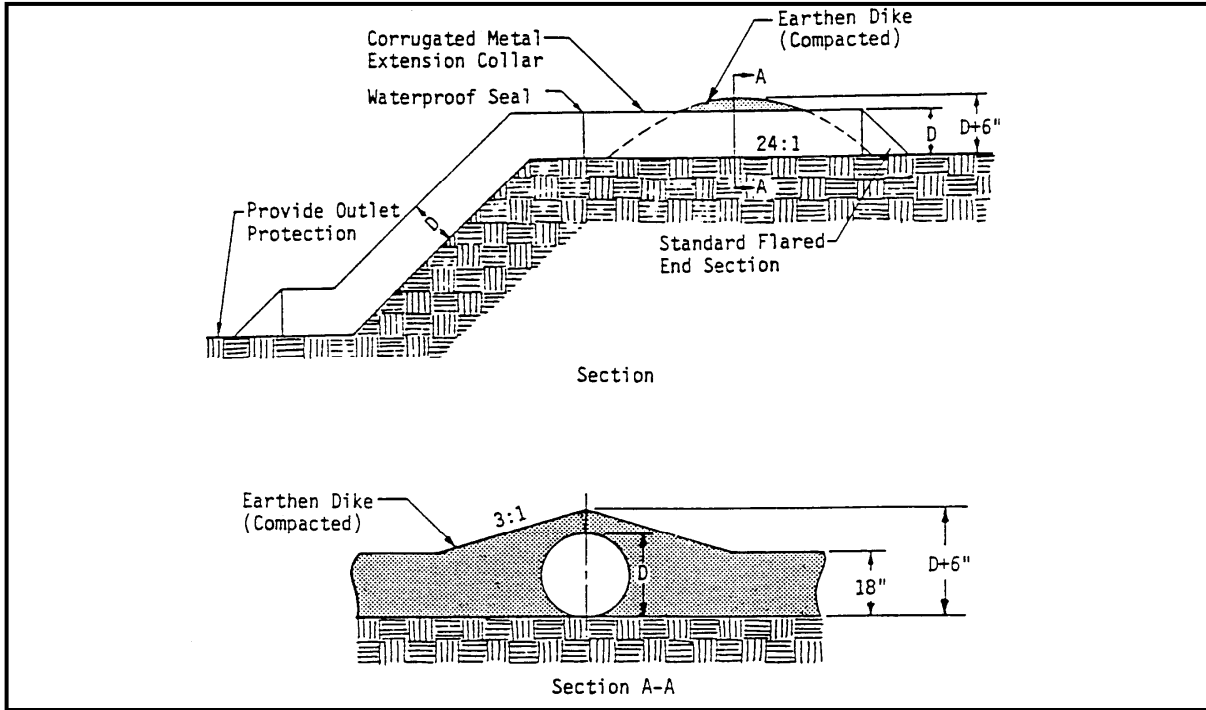

Figure 4.4j. Temporary Slope Drain

Source: Virginia Soil and Water Conservation Commission (SWCC)

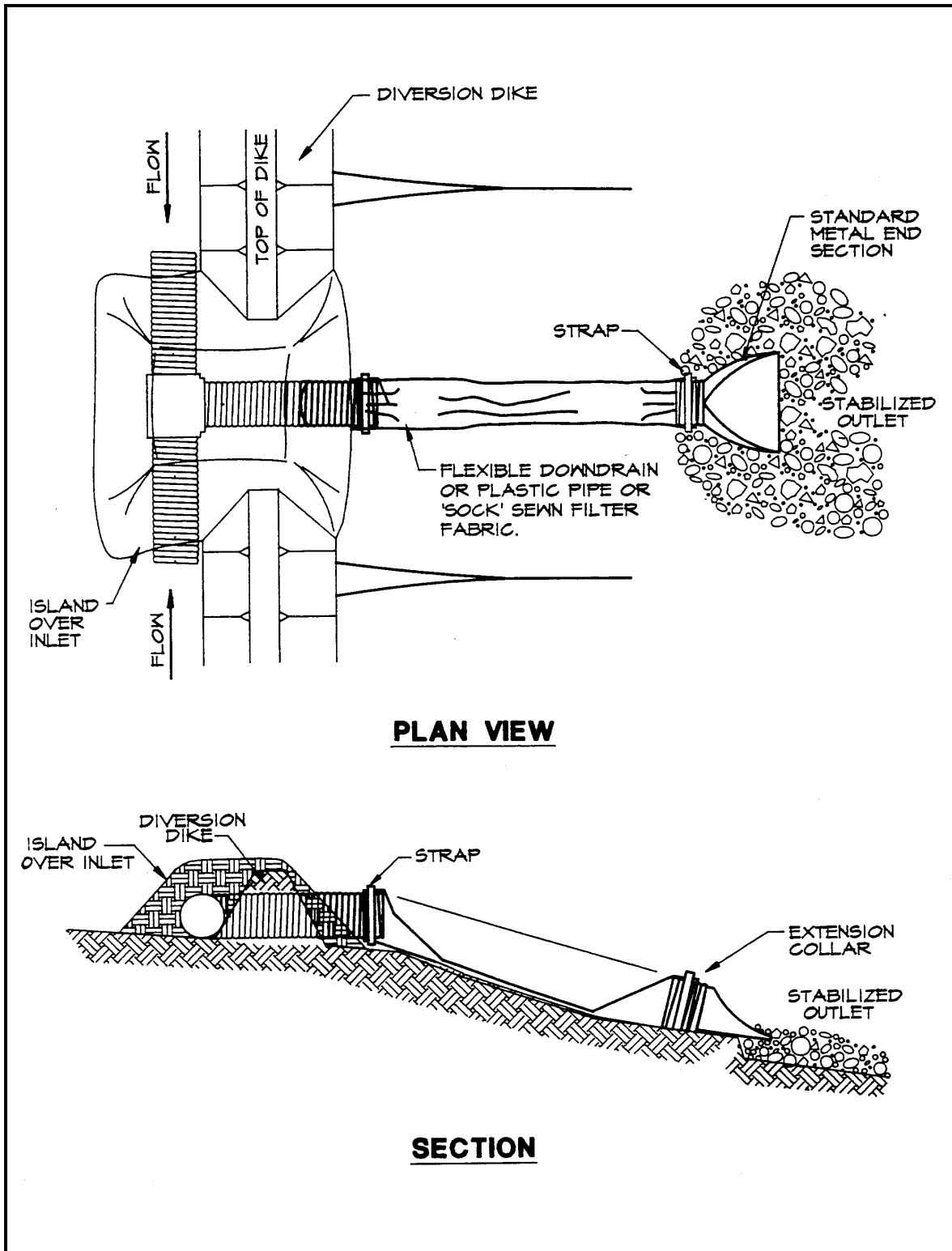

Figure 4.4k. Slope Drain

Source: Erosion Draw

4.4.6 Floating Turbidity Barrier

Definition

A floating geotextile material that minimizes sediment transport from a disturbed area adjacent to or within a waterbody.

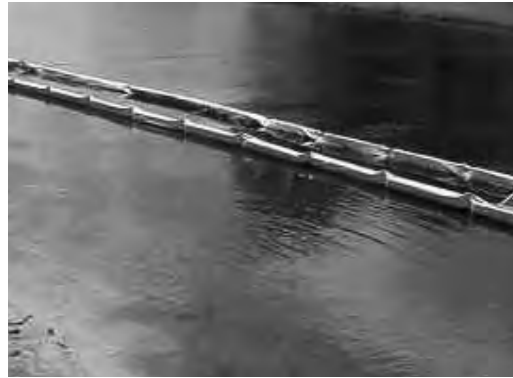

Purpose

To provide sedimentation protection for a watercourse from upslope land disturbance where conventional erosion and sediment controls cannot be used, or from dredging or filling within the watercourse.

Conditions Where Practice Applies

Applicable to nontidal and tidal watercourses where intrusion into the watercourse by construction activities has been permitted and subsequent sediment movement is unavoidable.

Planning Considerations

Soil loss into a watercourse results in the long-term suspension of sediment. In time, the suspended sediment may travel long distances and affect widespread areas. A turbidity curtain is designed to deflect and contain sediment within a limited area and provide enough residence time so that soil particles will fall out of suspension and not travel to other areas.

Turbidity curtain types must be selected based on the flow conditions in the waterbody, whether a flowing channel, lake, pond, or tidal watercourse. The specifications in this measure pertain to minimal and moderate flow conditions where the velocity of flow may reach 5 feet (1.5 m) per second (or a current of approximately 3 knots). For situations where there are greater flow velocities or currents, a qualified engineer and product manufacturer should be consulted.

Consideration must also be given to the direction of water movement in channel flow situations. Turbidity curtains are not designed to act as water impoundment dams and cannot be expected to stop the flow of a significant volume of water. They are designed and installed to trap sediment, not to halt the movement of water itself. **In most situations, turbidity curtains should not be installed across channel flows.**

In tidal or moving water conditions, provisions must be made to allow the volume of water contained within the curtain to change. Since the bottom of the curtain is weighted and external anchors are frequently added, the volume of water contained within the curtain will be much greater at high tide vs. low tide, and measures must be taken to prevent the curtain from submerging.

In addition to allowing slack in the curtain to rise and fall, water must be allowed to flow through the curtain, if the curtain is to remain in roughly the same place and maintain the same shape. Normally, this is achieved by constructing part of the curtain from a heavy,

woven filter fabric. The fabric allows the water to pass through the curtain but retains the sediment particles. Consideration should be given to the volume of water that must pass through the fabric and sediment particle size when specifying fabric permeability.

Sediment that has been deflected and settled out by the curtain **may be removed** if so directed by the onsite inspector or the permitting agency. However, the probable outcome of the procedure must be considered—**will it create more of a sediment problem by the resuspension of particles and by accidental dumping of the material through the equipment involved?**

It is, therefore, recommended that the soil particles trapped by a turbidity curtain only be removed if there has been a significant change in the original contours of the affected area in the watercourse. Regardless of the decision made, soil particles should always be allowed to settle for a **minimum of 6 to 12 hours** before their removal by equipment or before the removal of a turbidity curtain.

It is imperative that the intended function of the other controls in this chapter, **to keep sediment out of the watercourse**, be the strategy used in every erosion control plan. However, when proximity to the watercourse makes successfully mitigating sediment loss impossible, the use of the turbidity curtain during land disturbance is essential. **Under no circumstances shall permitted land-disturbing activities create violations of water quality standards!**

Design Criteria

1. *Type I configuration (see **Figure 4.4I**) should be used in protected areas where there is no current and the area is sheltered from wind and waves.*
2. *Type II configuration (see **Figure 4.4I**) should be used in areas where there may be low to moderate current running (up to 2 knots or 3.5 feet [1 m] per second) and/or wind and wave action can affect the curtain.*
3. *Type III configuration (see **Figure 4.4m**) should be used in areas where considerable current (up to 3 knots or 5 feet [1.5 m] per second) may be present, where tidal action may be present, and/or where the curtain may be subject to wind and wave action.*
4. *Turbidity curtains should extend the entire depth of the watercourse whenever it is not subject to tidal action and/or significant wind and wave forces. This prevents silt-laden water from escaping under the barrier, scouring and resuspending additional sediments.*
5. *In situations with tidal and/or wind and wave action, the curtain should never be so long as to touch the bottom. There should be a minimum 1 foot (30 cm) gap between the weighted lower end of the skirt and the bottom at mean low water. The movement of the lower skirt over the bottom due to tidal reverses or wind and wave action on the flotation system may fan and stir sediments already settled out.*
6. *In situations with tidal and/or wind and wave action, it is seldom practical to extend a turbidity curtain lower than 10 to 12 feet (3 to 4 m) below the surface, even in deep water. Curtains that are installed deeper than this will be subject to very large loads with consequent strain on curtain materials and the mooring system. In addition, a curtain installed in this*

manner can "billow up" toward the surface under the pressure of the moving water, resulting in an effective depth that is significantly less than the skirt depth.

7. Turbidity curtains should be located parallel to the direction of flow of a moving body of water. **They should not be placed across the main flow of a significant body of moving water.**
8. When sizing the length of the floating curtain, allow an additional 10 to 20% variance in the straight-line measurements. This will allow for measuring errors, make installation easier, and reduce stress from potential wave action during high winds.
9. An attempt should be made to avoid an excessive number of joints in the curtain; a minimum continuous span of 50 feet (15 m) between joints is a good rule of thumb.
10. To maintain stability, a maximum span of 100 feet (30 m) between anchor or stake locations is also a good rule to follow.
11. The ends of the curtain, both floating upper and weighted lower, should extend well up into the shoreline, especially if high-water conditions are expected. The ends should be secured firmly to the shoreline to fully enclose the area where sediment may enter the water.
12. When there is a specific need to extend the curtain to the bottom of the watercourse in tidal or moving water conditions, a heavy, woven, pervious filter fabric may be substituted for the normally recommended impervious geotextile. This creates a "flow-through" medium that significantly reduces the pressure on the curtain and helps to keep it in the same relative location and shape during the rise and fall of tidal waters.
13. **Figure 4.4m** shows the typical alignments of turbidity curtains. The number and spacing of external anchors may vary depending on current velocities and potential wind and wave action; the manufacturer's recommendations should be followed.
14. Be certain that the type, location, and installation of the barrier are as shown on the approved plan and permit. Additional permits may be required in navigable waterways, especially when the barrier creates an obstruction.

Construction Specifications

Materials

1. Barriers should be a bright color (yellow or "international" orange are recommended) that will attract the attention of nearby boaters.
2. The curtain fabric must meet the minimum requirements.
3. Seams in the fabric shall be either vulcanized welded or sewn, and shall develop the full strength of the fabric.
4. Flotation devices shall be flexible, buoyant units contained in an individual flotation sleeve or collar attached to the curtain. Buoyancy provided by

*the flotation units shall be sufficient to support the weight of the curtain and maintain a freeboard of at least 3 inches (8 cm) above the water surface level (see **Figure 4.4n**).*

5. *Load lines must be fabricated into the bottom of all floating turbidity curtains. Types II and III must have load lines also fabricated into the top of the fabric. The top load line shall consist of woven webbing or vinyl-sheathed steel cable and shall have a break strength in excess of 10,000 pounds (4.5 tonnes [t]). The supplemental (bottom) load-line shall consist of a chain incorporated into the bottom hem of the curtain of sufficient weight to serve as ballast to hold the curtain in a vertical position. Additional anchorage shall be provided as necessary. The load lines shall have suitable connecting devices that develop the full breaking strength for connecting to load lines in adjacent sections (see **Figures 4.4l** and **4.4m**, which portray this orientation).*
6. *External anchors may consist of 2 x 4 inch (5 x 10 cm) or 2 ½ inch (6 cm) minimum diameter wooden stakes, or 1.33 pounds per linear foot (2 kilograms [kg]/m) steel posts when Type I installation is used; with Type II or Type III installations, bottom anchors should be used.*
7. *Bottom anchors must be sufficient to hold the curtain in the same position relative to the bottom of the watercourse without interfering with the action of the curtain. The anchor may dig into the bottom (grappling hook, plow or fluke-type) or may be weighted (mushroom-type) and should be attached to a floating anchor buoy via an anchor line. The anchor line then runs from the buoy to the top load line of the curtain. When used with Type III installations, these lines must contain enough slack to allow the buoy and curtain to float freely with tidal changes without pulling the buoy or curtain down, and must be checked regularly to make sure they do not become entangled with debris. As previously noted, anchor spacing varies with current velocity and expected wind and wave action; the manufacturer's recommendations should be followed (see the orientation of external anchors and anchor buoys for tidal installation in **Figure 4.4m**).*

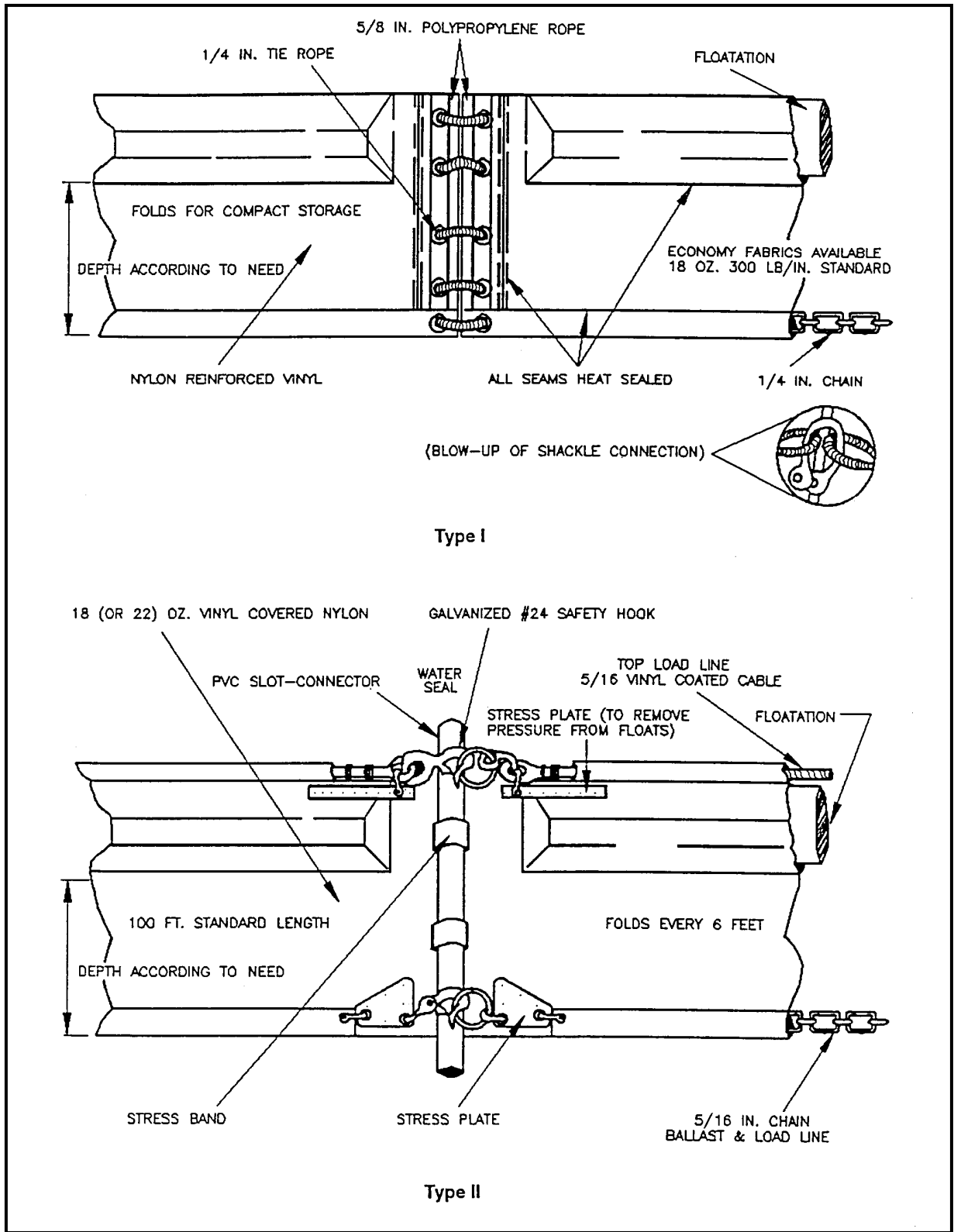

Figure 4.4l. Type I and II Floating Turbidity Barriers

Source: American Boom and Barrier Corporation

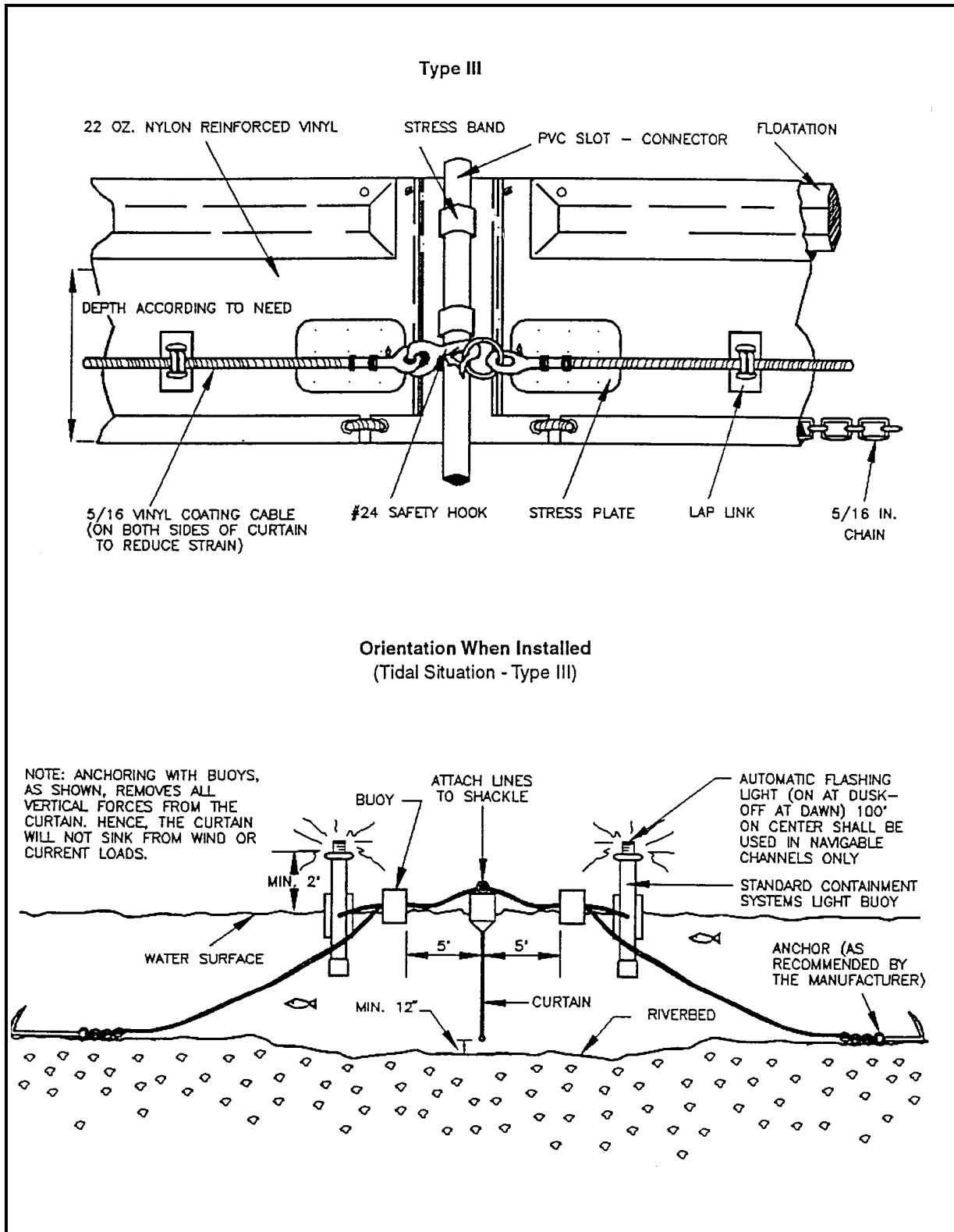

Figure 4.4m. Type III Floating Turbidity Barrier

Source: American Boom and Barrier Corporation and Virginia Department of Transportation (DOT) Standard Sheets

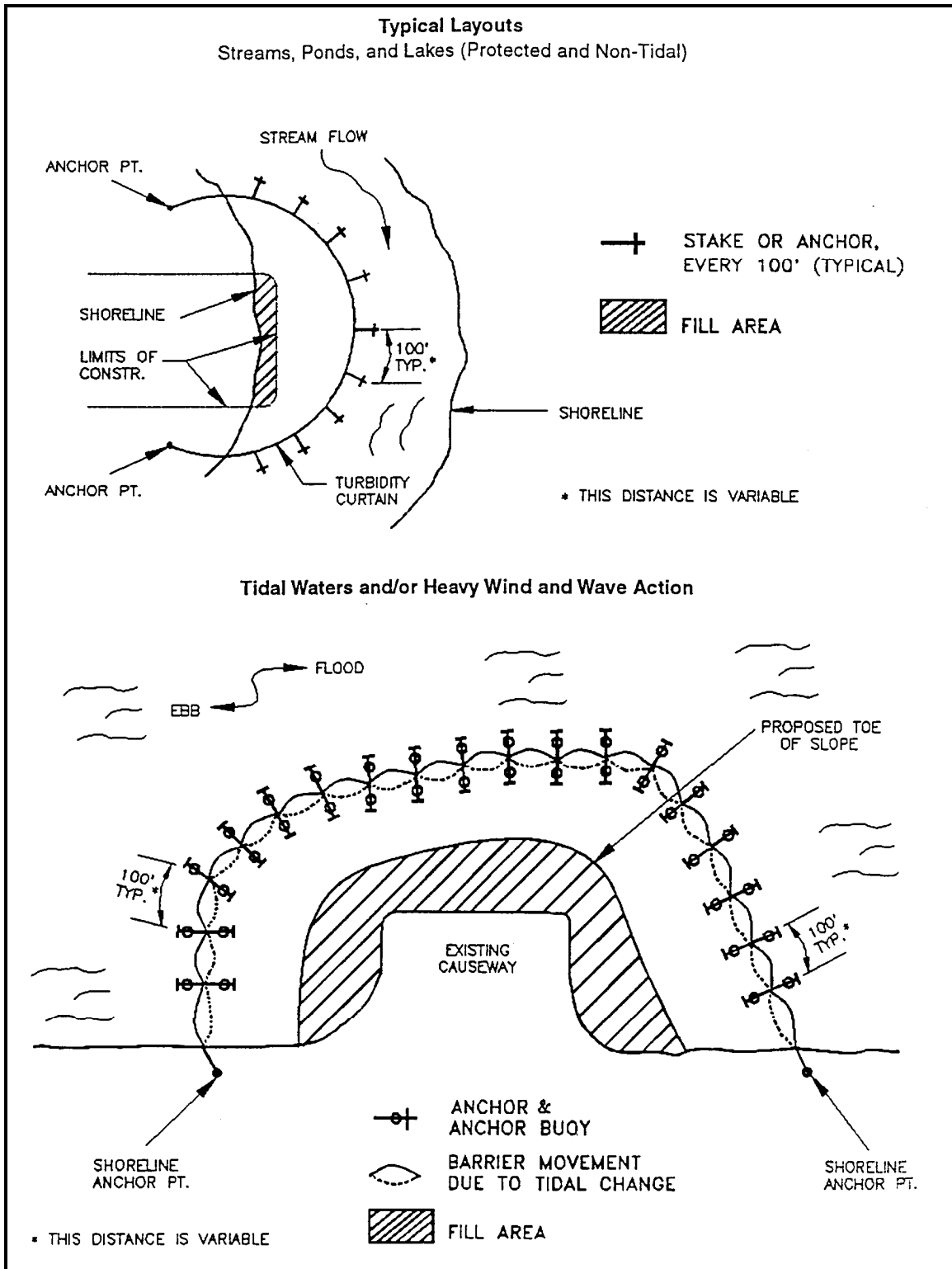

Figure 4.4n. Typical Installation Layouts

Source: FDOT Roadway and Traffic Design Standards

Installation

1. *In the calm water of lakes or ponds (Type I installation), it is usually sufficient to merely set the curtain end stakes or anchor points (using anchor buoys if bottom anchors are employed), then tow the curtain **in the furled condition** out and attach it to these stakes or anchor points. Following this, any additional stakes or buoyed anchors required to maintain the desired location of the curtain may be set and these anchor points made fast to the curtain. **Only then** should the furling lines be cut to let the curtain skirt drop.*
2. *In rivers or in other moving water (Type II and III installations), it is important to set all the curtain anchor points. Care must be taken to ensure that anchor points are of sufficient holding power to retain the curtain under the expected current conditions, before putting the furled curtain into the water. Anchor buoys should be employed on all anchors to prevent the current from submerging the flotation at the anchor points. If the moving water into which the curtain is being installed is tidal and will subject the curtain to currents in both directions as the tide changes, it is important to provide anchors on both sides of the curtain for two reasons, as follows:*
 - a. *Curtain movement will be minimized during tidal current reversals, and*
 - b. *The curtain will not overrun the anchors or pull them out when the tide reverses.*

When the anchors are secure, the furled curtain should be secured to the upstream anchor point and then sequentially attached to each next downstream anchor point until the entire curtain is in position. At this point, and before unfurling, the "lay" of the curtain should be assessed and any necessary adjustments made to the anchors. Finally, when the desired location is achieved, the furling lines should be cut to allow the skirt to drop.

3. **Always attach anchor lines to the flotation device, not to the bottom of the curtain.** *The anchoring line attached to the flotation device on the downstream side will provide support for the curtain. Attaching the anchors to the bottom of the curtain could cause premature failure of the curtain due to the stresses imparted on the middle section of the curtain.*
4. *There is an exception to the rule that turbidity curtains should not be installed across channel flows: when there is a danger of creating a silt buildup in the middle of a watercourse, thus blocking access or creating a sandbar. Curtains have been used effectively in large areas of moving water by forming a very long-sided, sharp "V" to deflect clean water around a work site, confine a large part of the silt-laden water to the work area inside the "V," and direct much of the silt toward the shoreline. Care must be taken, however, not to install the curtain perpendicular to the water current.*
5. *See **Figure 4.4n** for typical installation layouts.*
6. *The effectiveness of the barrier can be increased by installing 2 parallel curtains, separated at regular intervals by 10 foot (3 m) long wooden boards or lengths of pipe.*

Removal

1. *Care should be taken to protect the skirt from damage as the turbidity curtain is dragged from the water.*
2. *The site selected to bring the curtain ashore should be free of sharp rocks, broken cement, debris, etc., to minimize damage when hauling the curtain over the area.*
3. *If the curtain has a deep skirt, it can be further protected by running a small boat along its length with a crew installing furling lines before attempting to remove the curtain from the water.*

Maintenance

1. *The developer/owner shall be responsible for maintaining the filter curtain for the duration of the project to ensure the continuous protection of the watercourse.*
2. *Should repairs to the geotextile fabric become necessary, repair kits are normally available from the manufacturer; the manufacturer's instructions must be followed to ensure the adequacy of the repair.*
3. *When the curtain is no longer required as determined by the inspector, the curtain and related components shall be removed in a manner that minimizes turbidity. Sediment shall be removed and the original depth (or plan elevation) restored before removing the curtain. The remaining sediment shall be sufficiently settled before the curtain is removed. Any spoils must be taken to an upland area and stabilized.*

4.5 Storm Drain Inlet Protection

Definition

A sediment filter or an excavated impounding area around a storm drain drop inlet or curb inlet.

Purpose

To prevent sediment from entering stormwater conveyance systems prior to permanent stabilization of the disturbed area.

Condition Where Practice Applies

Where storm drain inlets are to be made operational before permanent stabilization of the disturbed drainage area. Different types of structures are applicable to different conditions (see **Figures 4.5a** through **4.5j**).

Planning Considerations

Storm sewers that are made operational before their drainage area is stabilized can convey large amounts of sediment to receiving waters. In the case of extreme sediment loading, the storm sewer itself may clog and lose most of its capacity. To avoid these problems, it is necessary to prevent sediment from entering the system at the inlets.

There are several types of inlet filters and traps, which have different applications depending on the site conditions and type of inlet. Other innovative techniques for accomplishing the same purpose are encouraged, but only after specific plans and details are submitted to and approved by the stormwater permitting agency.

Note that these various inlet protection devices are for drainage areas of **less than 1 acre (0.4 ha)**. Runoff from large, disturbed areas should be routed through a **TEMPORARY SEDIMENT TRAP (Chapter 4)**.

Design Criteria

- 1. The drainage area shall be no greater than 1 acre (0.4 ha).*
- 2. The inlet protection device shall be constructed to facilitate the cleanout and disposal of trapped sediment and to minimize interference with construction activities.*
- 3. The inlet protection devices shall be constructed so that any resultant ponding or stormwater will not cause excessive inconvenience or damage to adjacent areas or structures.*
- 4. **Figures 4.5a** through **4.5j** provide specific design criteria for each particular inlet protection device.*

Construction Specifications

Fabric Drop Inlet Sediment Filter

1. Fabric shall be cut from a continuous roll to avoid joints.
2. Stakes shall be 2 x 4 inches (5 x 10 cm) wood (preferred) or equivalent metal with a minimum length of 3 feet (90 cm) (see **Figure 4.5a**).
3. Staples shall be of heavy duty wire at least ½ inch (13 mm) long.
4. Stakes shall be spaced around the perimeter of the inlet a maximum of 3 feet (90 cm) apart and securely driven into the ground a minimum of 8 inches (20 cm). A frame of 2 x 4 inches (5 x 10 cm) of wood shall be constructed around the top of the stakes for proper stability.
5. A trench shall be excavated approximately 4 inches (10 cm) wide and 4 inches (10 cm) deep around the outside perimeter of the stakes (see **Figure 4.5b**).
6. The fabric shall be stapled to the wooden stakes, and 8 inches (20 cm) of the fabric shall be extended into the trench. The height of the filter barrier shall be a minimum of 15 inches (38 cm) and shall not exceed 18 inches (45 cm).
7. The trench shall be backfilled and the soil compacted over the fabric.



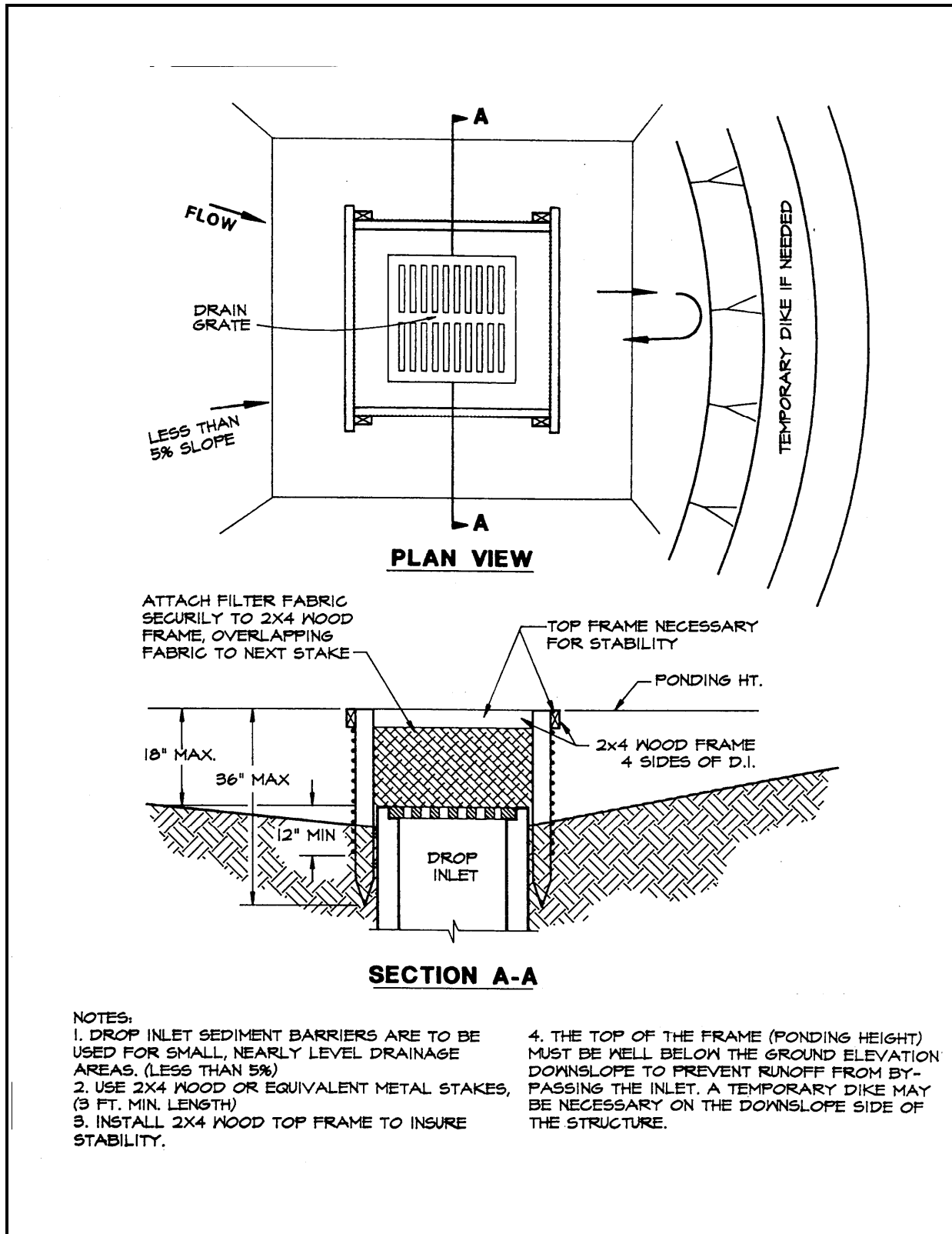

Figure 4.5a. Silt Fence Drop Inlet Sediment Barrier

Source: Erosion Draw

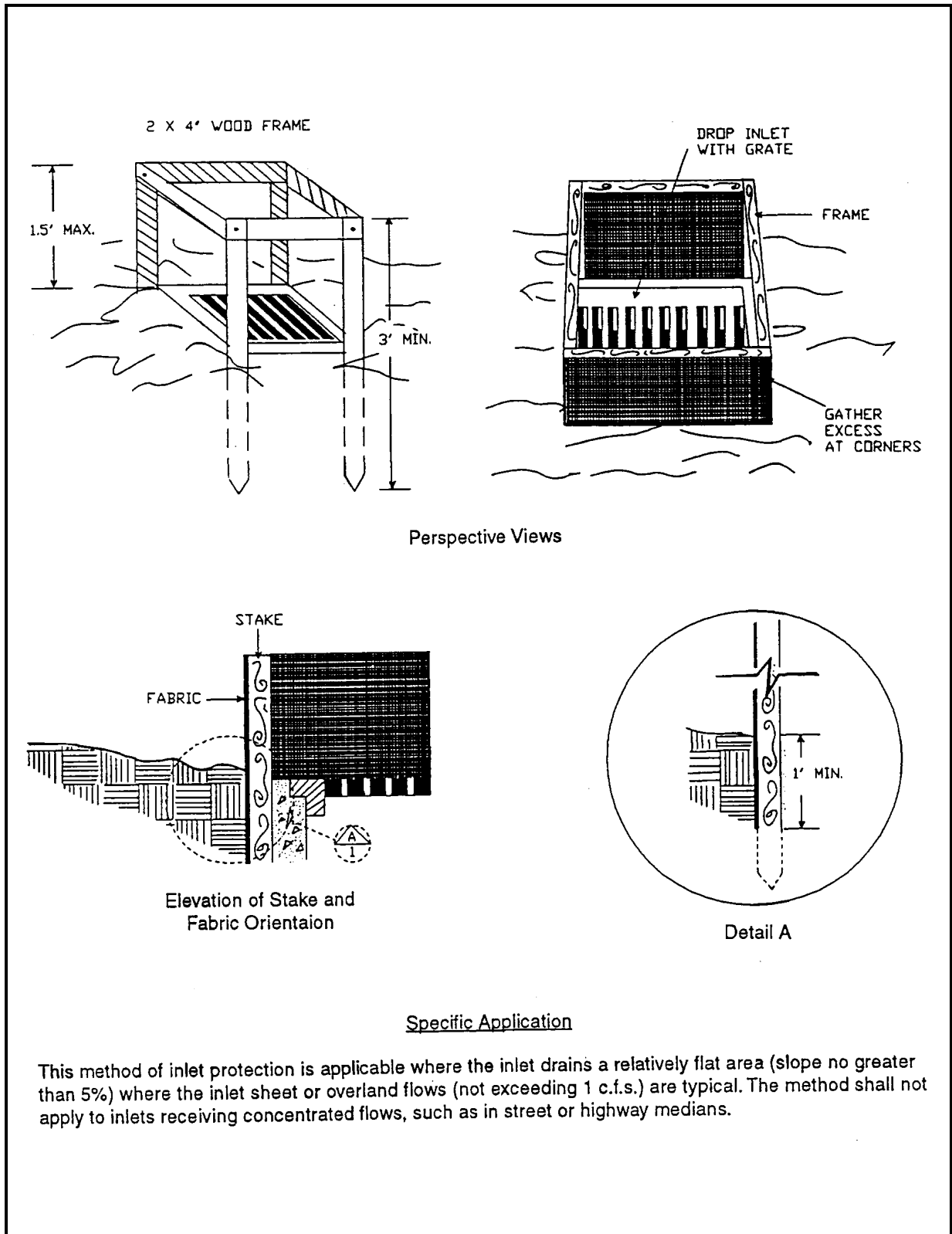

Figure 4.5b. Filter Fabric Drop Inlet Sediment Filter

Source: North Carolina Erosion and Sediment Control Manual

Gravel and Wire Mesh Drop Inlet Sediment Filter

1. *Wire mesh shall be laid over the drop inlet so that the wire extends a minimum of 1 foot (30 cm) beyond each side of the inlet structure. Hardware cloth or comparable wire mesh with ½ inch (13 mm) openings shall be used. If more than 1 strip of mesh is necessary, the strips shall be overlapped at least 1 foot (30 cm).*



2. *FDOT No. 1 Coarse Aggregate (1.5 to 3.5 inch) (4 to 9 cm) stone shall be placed over the wire mesh, as shown in **Figure 4.5c**. The depth of the stone shall be at least 12 inches (30 cm) over the entire inlet opening. The stone shall extend beyond the inlet opening at least 18 inches (45 cm) on all sides (see **Figure 4.5c**).*
3. *If the stone filter becomes clogged with sediment so that it no longer adequately performs its function, the stones must be pulled away from the inlet, cleaned, and replaced.*

NOTE: *This filtering device has no overflow mechanism. Therefore, ponding is likely, especially if sediment is not removed regularly. This type of device must **NEVER** be used where overflow may endanger an exposed fill slope. Consideration should also be given to the possible effects of ponding on traffic movement, nearby structures, working areas, adjacent property, etc.*

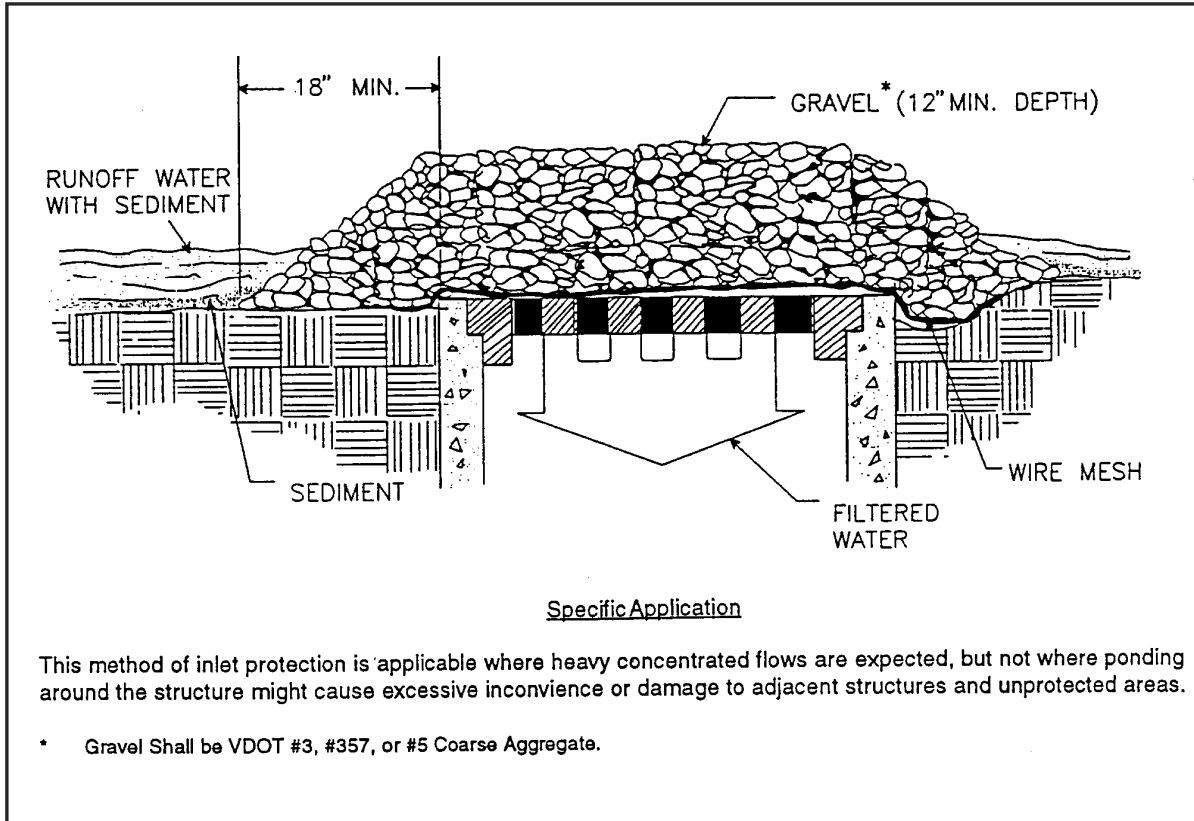

Figure 4.5c. Gravel and Wire Mesh Drop Inlet Sediment Filter

Source: Virginia DSWC

Block and Gravel Drop Inlet Sediment Filter

1. Place concrete blocks lengthwise on their sides in a single row around the perimeter of the inlet, with the ends of adjacent blocks abutting. The height of the barrier can be varied, depending on design needs, by stacking combinations of 4, 8, and 12 inch wide (10, 20, and 30 cm) blocks. The barrier of blocks shall be at least 12 inches (30 cm) high and no greater than 24 inches (60 cm) high.
2. Wire mesh shall be placed over the outside vertical face (webbing) of the concrete blocks to prevent stone from being washed through the holes in the blocks. Hardware cloth or comparable wire mesh with ½ inch (13 mm) openings shall be used (see **Figure 4.5d**).
3. Stone shall be piled against the wire to the top of the block barrier. Suitable coarse aggregate shall be used (see **Figure 4.5d**).
4. If the stone filter becomes clogged with sediment so that it no longer adequately performs its function, the stone must be pulled away from the blocks, cleaned, and replaced.

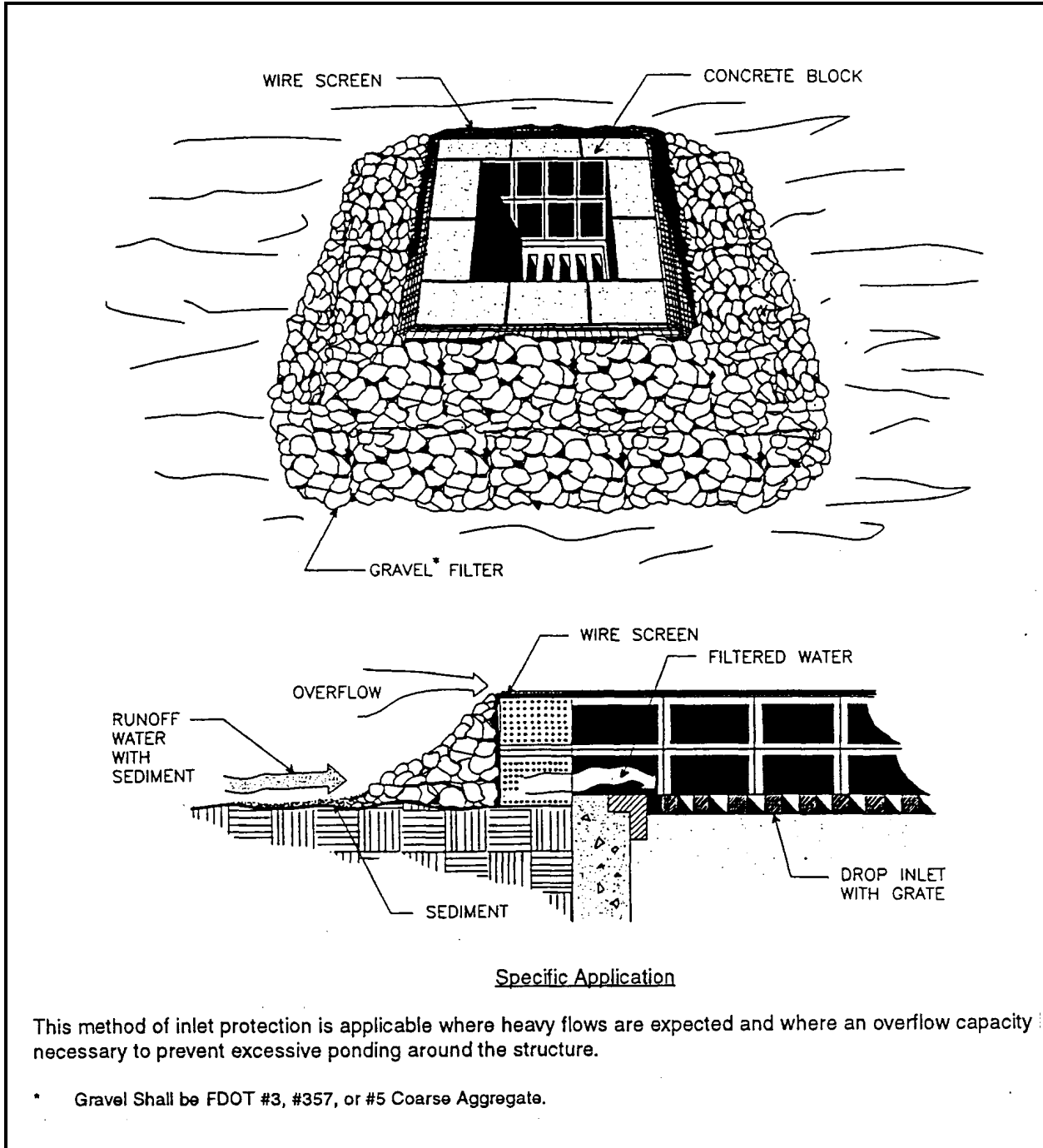

Figure 4.5d. Block and Gravel Drop Inlet Sediment Filter

Source: Michigan Soil Erosion and Sedimentation Control Guidebook

5. As a very temporary alternative, pervious burlap bags filled with gravel may be placed around the inlet, provided that there are no gaps between the bags (see **Figure 4.5e**).
6. Either of these two practices may be installed on pavement or bare ground.

Sod Drop Inlet Sediment Filter

1. Soil shall be prepared and sod installed according to the specifications in **SODDING (Chapter 7)**.
2. Sod shall be placed to form a turf mat covering the soil for a distance of 4 feet (1.2 m) from each side of the inlet structure (see **Figure 4.5f**).



Prefabricated Drop Inlet Internal Filter Bag

1. Remove the grate over the catch basin and insert the filter device, then replace the grate to hold the device in position.
2. When sediments have accumulated to within 1 foot (30 cm) of the grate, the filter insert must be removed by a front-end loader or forklift. The filter may be discarded and replaced, or it may be emptied, cleaned, and reused.

Filter Sock Drop Inlet Filter

1. The filter sock should be placed around the entire circumference of the drop inlet and should allow for at least 1 foot of overlap on either side of the opening being protected. Stakes should be used to keep the sock in place.
2. Under low-flow conditions, a 9-inch or 12-inch sock diameter should suffice.
3. Sediment will collect around the outside of the filter sock and should be removed when the sediment reaches one-half of the sock height.



Prefabricated Drop Inlet External Filter

1. *Place the device over the inlet. If the inlet has a grate, the device shall be secured to the grate by means of a long toggle bolt. If the grate is not present, the device shall be bolted directly to the concrete.*
2. *Sediments shall be removed when they have accumulated to within 1 foot (30 cm) of the top of the device. The filter fabric elements shall be cleaned or replaced at that time.*



NOTE: *This segment does not constitute a product endorsement.*

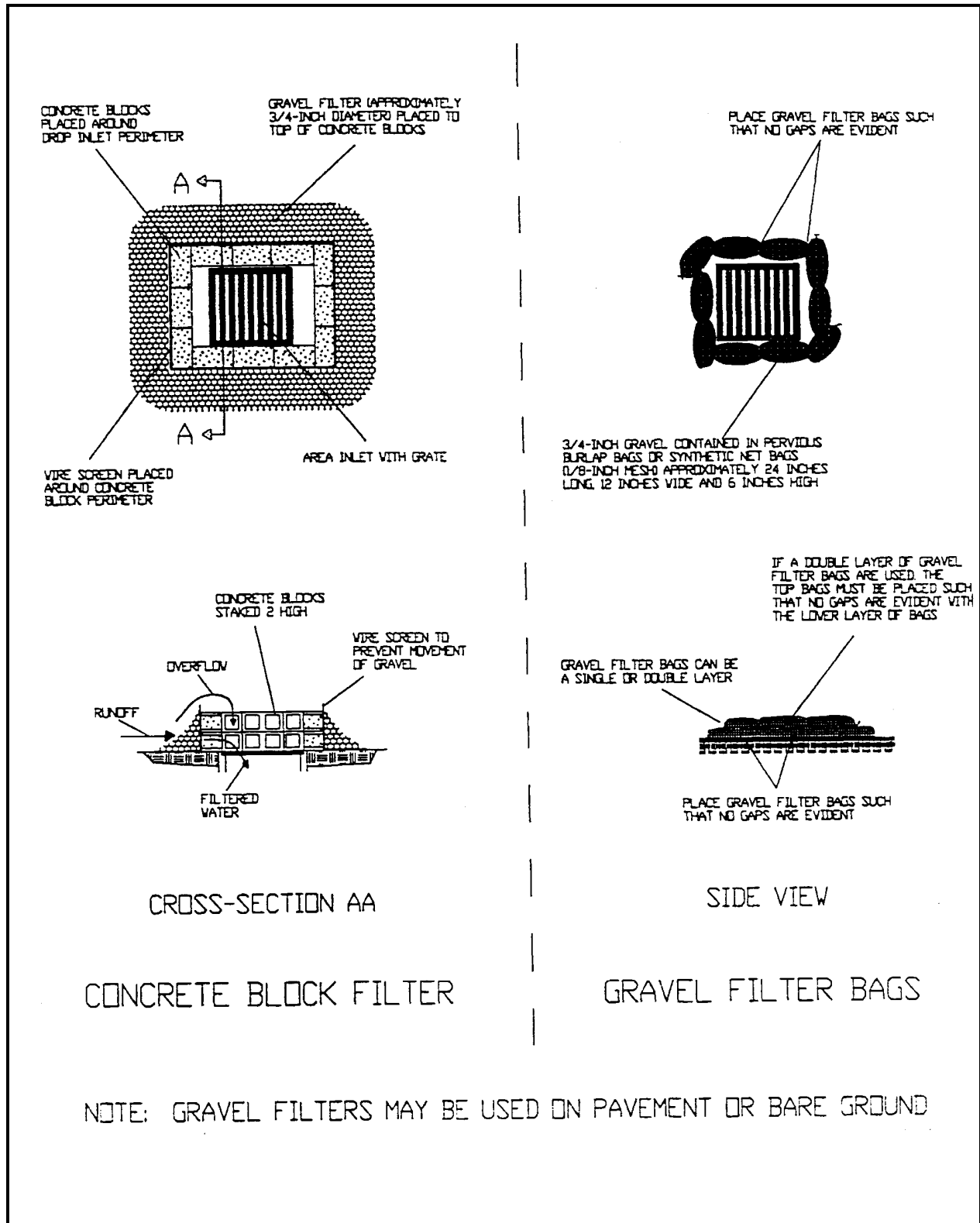

Figure 4.5e. Gravel Filters for Area Inlets

Source: HydroDynamics, Inc.

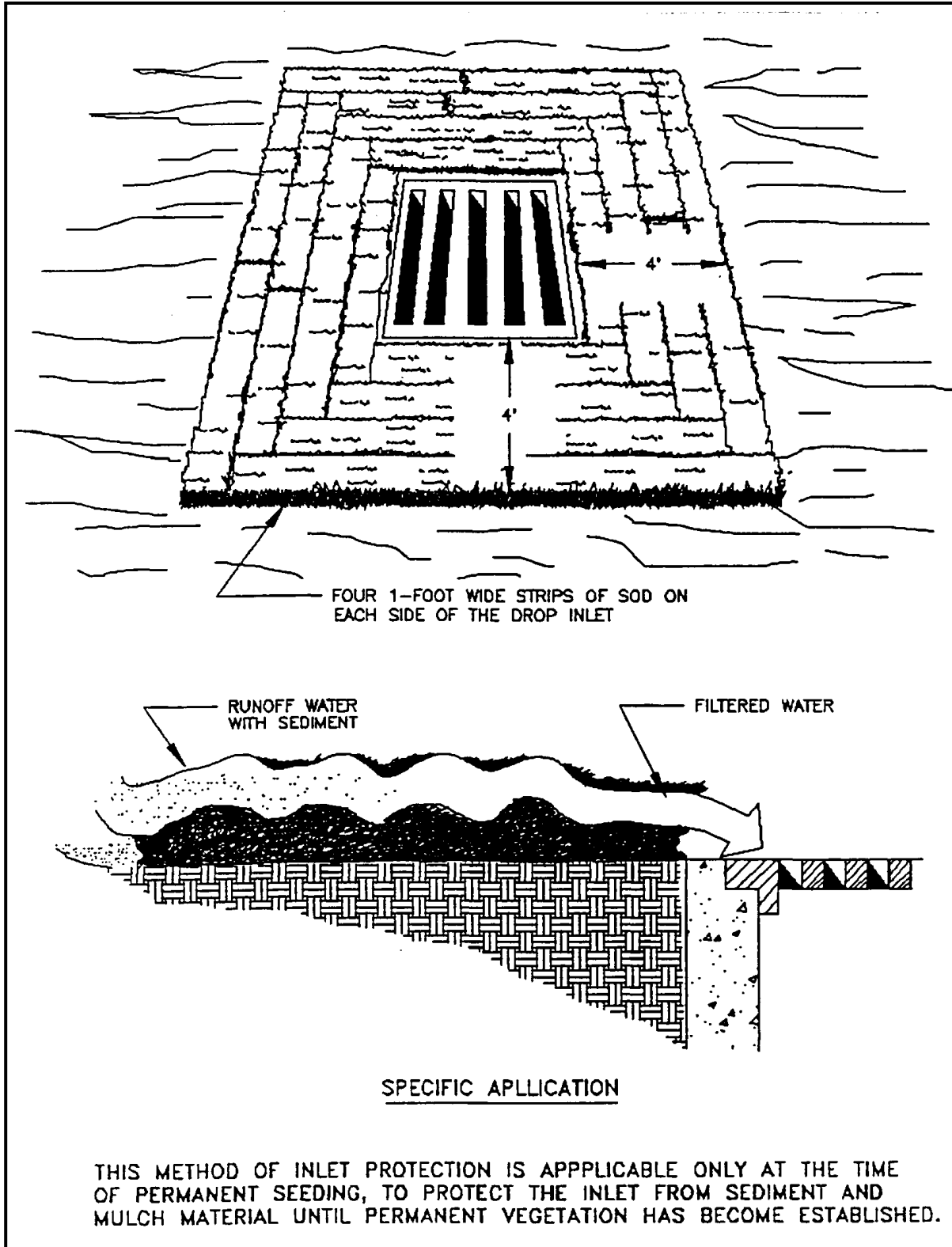

Figure 4.5f. Sod Drop Inlet Sediment Filter

Source: Virginia DSWC

Gravel Curb Inlet Sediment Filter

1. *Hardware cloth or comparable wire mesh with ½ inch (13 mm) openings shall be placed over the curb inlet opening so that at least 12 inches (30 cm) of wire extends across the top of the inlet cover and at least 12 inches (30 cm) of wire extends across the concrete gutter from the inlet opening (see **Figure 4.5g**).*
2. *Stone shall be piled against the wire so as to anchor it against the gutter and inlet cover and to cover the inlet opening completely. FDOT No. 1 Coarse Aggregate shall be used.*
3. *An overflow weir can be constructed of 2 x 4 inch (5 x 10 cm) boards to lessen ponding from this practice (see **Figure 4.5h**).*
4. *If the stone filter becomes clogged with sediment so that it no longer adequately performs its function, the stone must be pulled away from the block, cleaned, and replaced.*

Block and Gravel Curb Inlet Sediment Filter

1. *Two concrete blocks shall be placed on their sides abutting the curb at either side of the inlet opening (see **Figure 4.5i**).*
2. *A 2 x 4 inch (5 x 10 cm) board shall be cut and placed through the outer holes of each spacer block to help keep the front blocks in place.*
3. *Concrete blocks shall be placed on their sides across the front of the inlet and abutting the spacer blocks (see **Figure 4.5j**).*
4. *Wire mesh shall be placed over the outside vertical face (webbing) of the concrete blocks to prevent stone from being washed through the holes in the blocks. Hardware cloth with ½ inch (13 mm) openings shall be used.*
5. *FDOT No. 1 Coarse Aggregate shall be piled against the wire to the top of the barrier.*

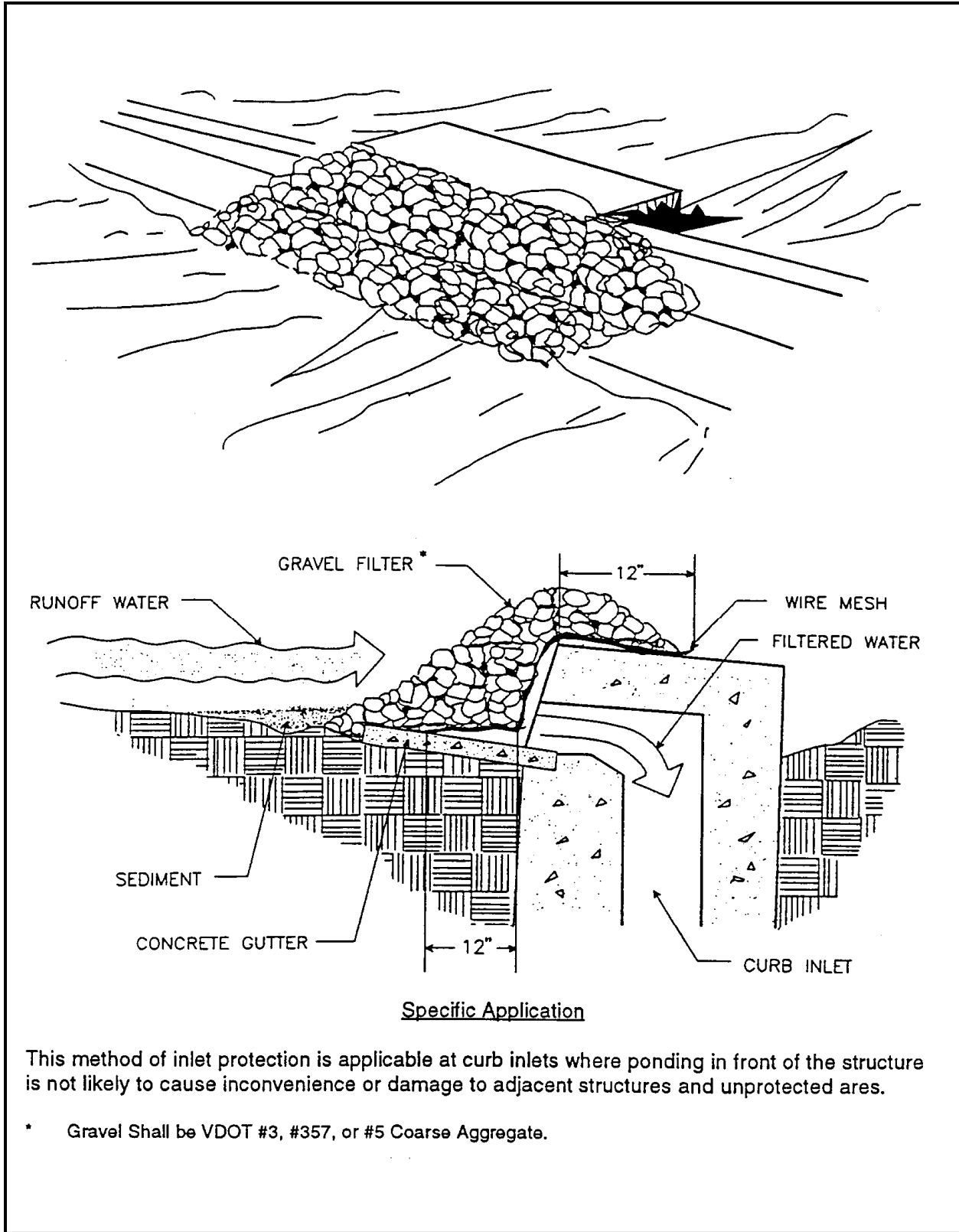

Figure 4.5g. Gravel Curb Inlet Sediment Filter

Source: Virginia DSWC

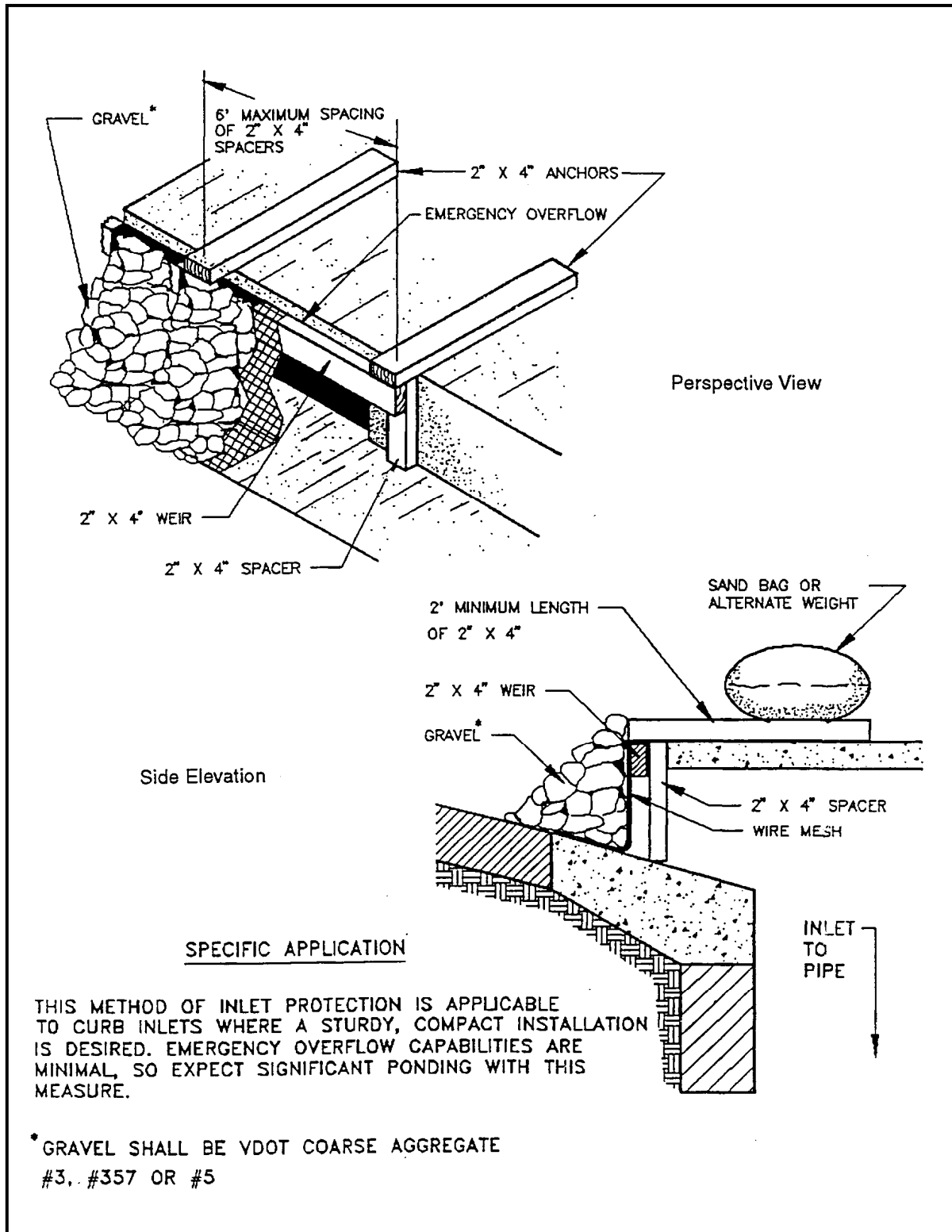

Figure 4.5h. Gravel Curb Inlet Sediment Filter with Overflow Weir

Source: Maryland Standards and Specifications for Soil Erosion and Sediment Control

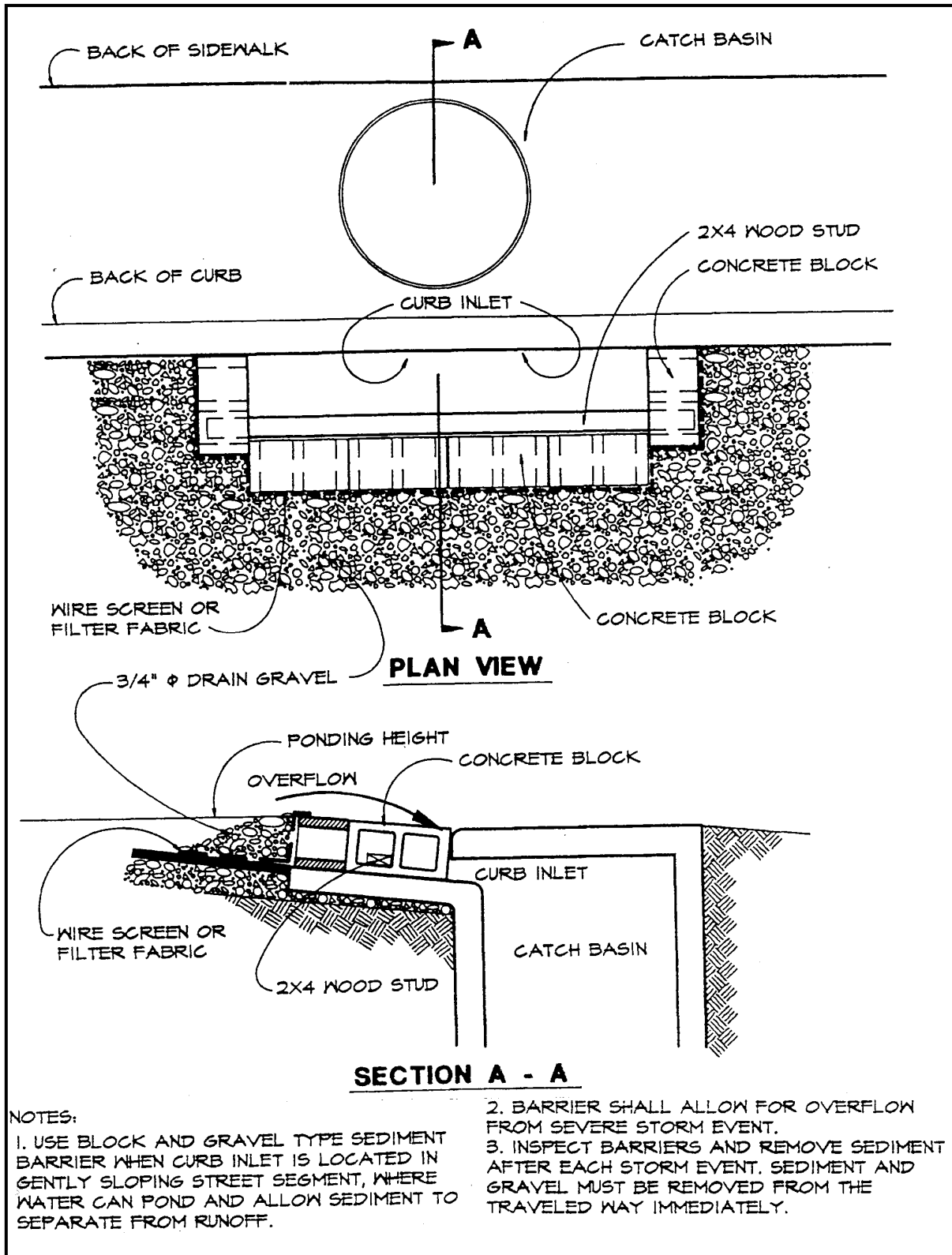

Figure 4.5i. Block and Gravel Curb Inlet Sediment Barrier

Source: Erosion Draw

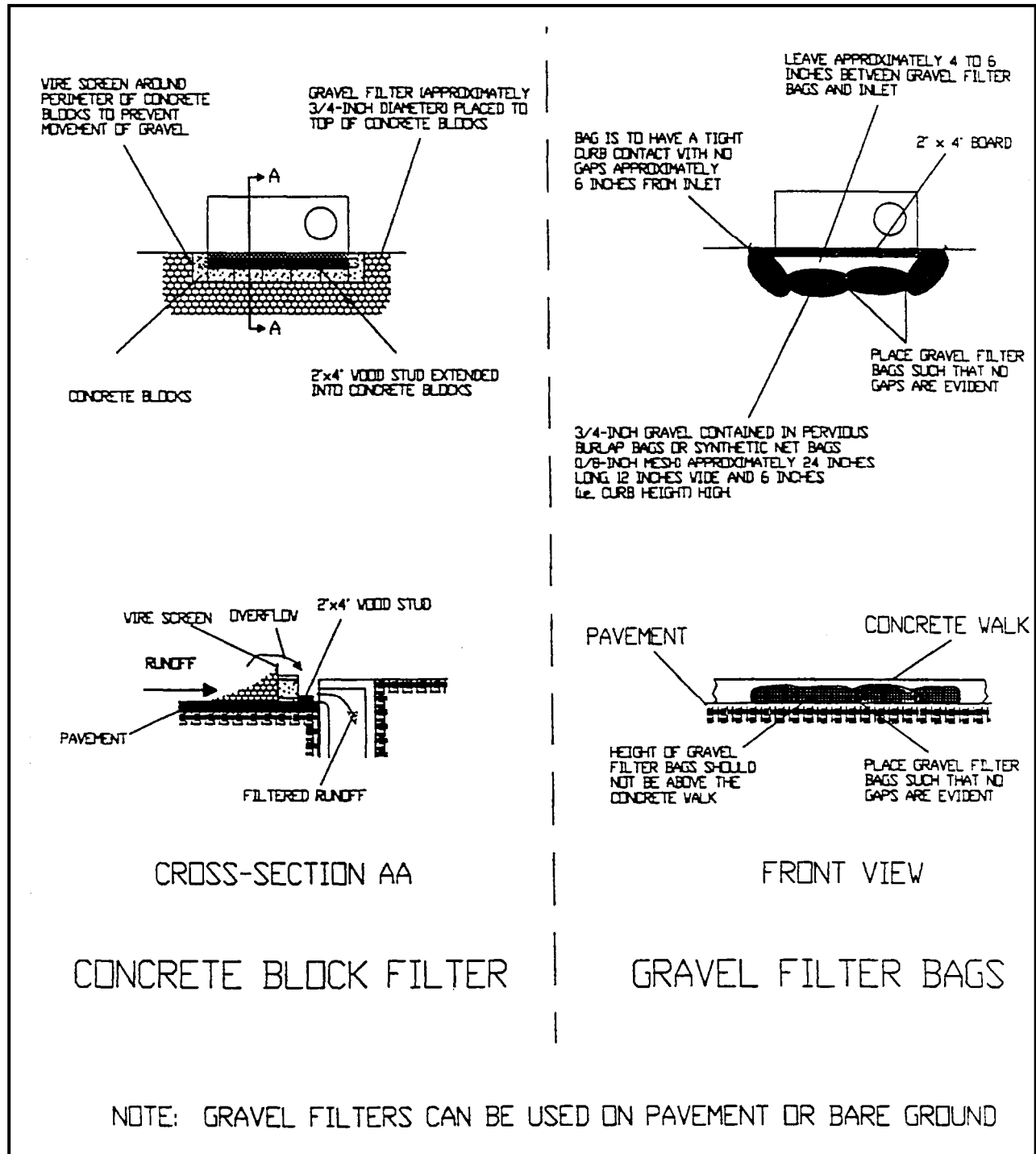

Figure 4.5j. Curb Inlet Gravel Filters

Source: HydroDynamics, Inc.

6. *If the stone filter becomes clogged with sediment so that it no longer adequately performs its function, the stone must be pulled away from the block, cleaned, and replaced.*
7. *As an alternative, gravel-filled burlap bags may be stacked tightly around the curb inlet (see **Figures 4.5k** and **4.5l**).*

Curb and Gutter Sediment Barrier

1. *Place gravel-filled burlap bags on gently sloping street segments according to the spacing chart (see **Figure 4.5m**).*
2. *Place two or more bags at each interval in a manner that provides maximum support.*
3. *When stacking several bags high, leave a one-bag gap to provide an overflow spillway (see **Figure 4.5m**).*
4. *Sediments must be removed after each rain event.*



Maintenance

1. *The structure shall be inspected after each rain and repairs made as needed.*
2. *The sediment shall be removed and the trap restored to its original dimensions when the sediment has accumulated to one-half of the design depth of the trap. The removed sediment shall be deposited in a suitable area and in such a manner that it will not erode.*
3. *Structures shall be removed and the area stabilized when the remaining drainage area has been properly stabilized.*

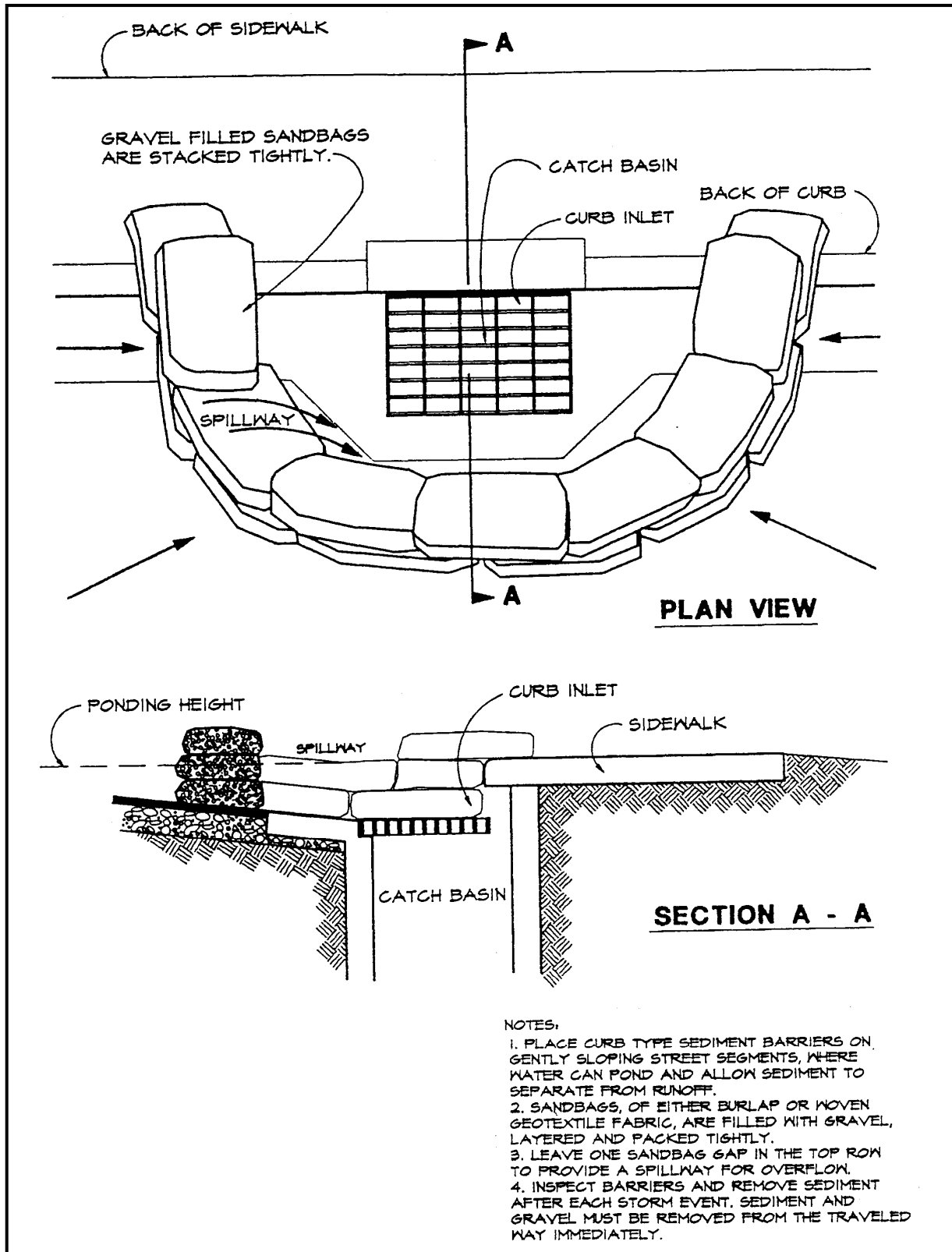

Figure 4.5k. Curb Inlet Sediment Barrier

Source: Erosion Draw

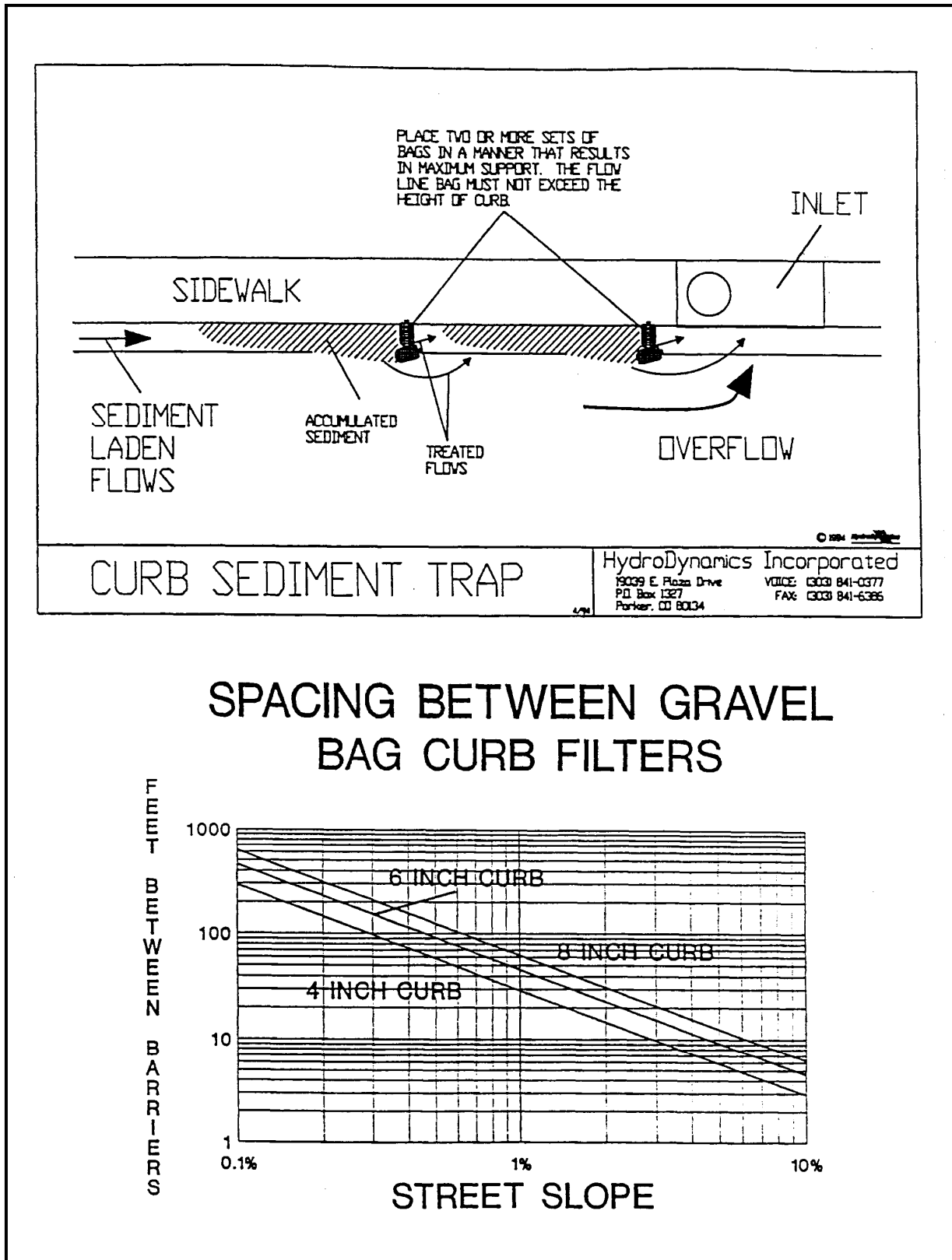

Figure 4.5I. Gravel Bag Curb Sediment Filters

Source: HydroDynamics, Inc.

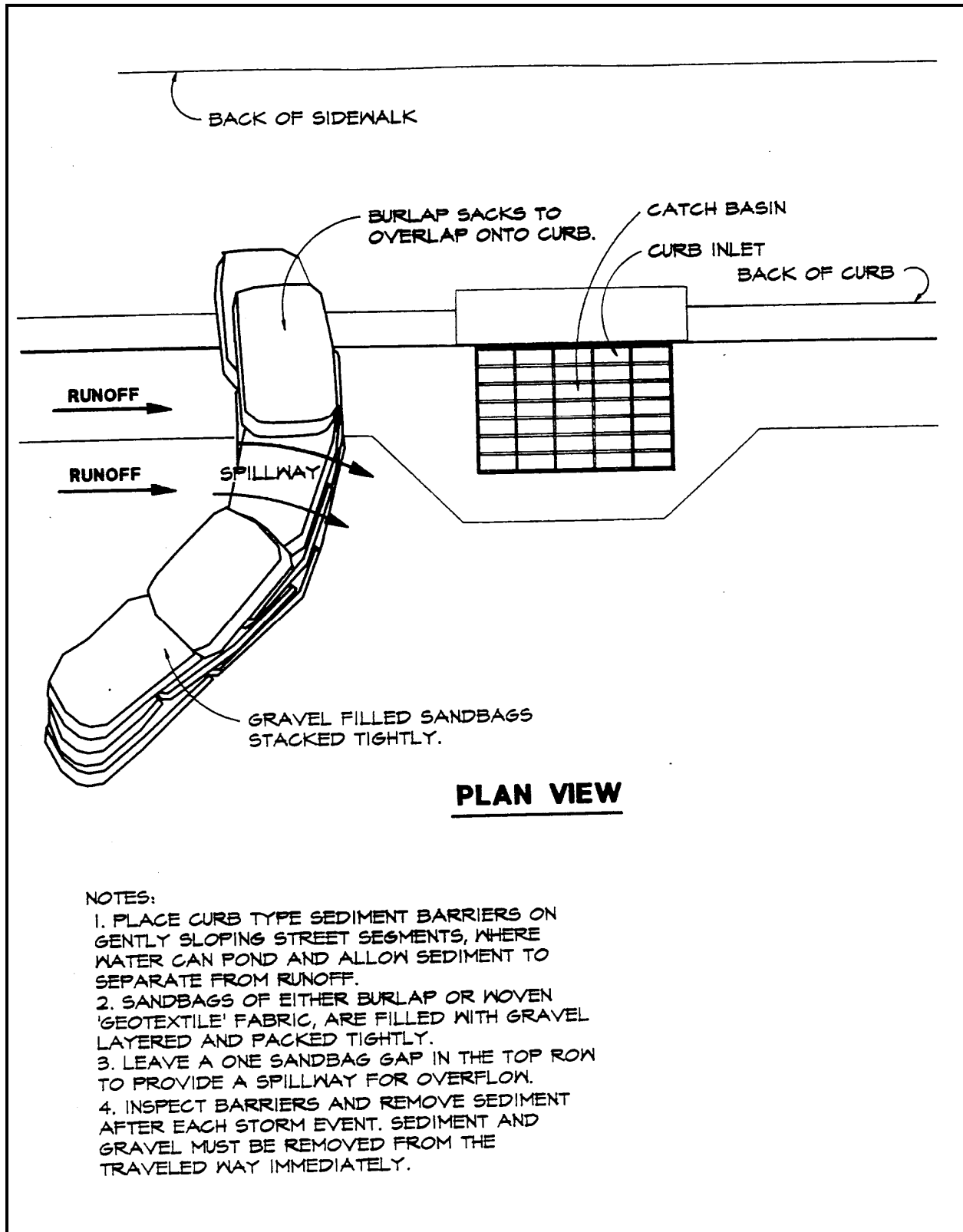

Figure 4.5m. Curb and Gutter Sediment Barrier

Source: Erosion Draw

4.6 Temporary Sediment Trap

Definition

A small, temporary ponding area formed by excavation and/or an embankment across a drainageway.

Purpose

To detain sediment-laden runoff from small disturbed areas long enough to allow most of the sediment to settle out, thus protecting drainageways, properties, and rights of way from sedimentation.



Conditions Where Practice Applies

1. *A sediment trap is usually installed in a drainageway, at a storm drain inlet, or at other points of discharge from a disturbed area.*
2. *It is installed below drainage areas of 5 acres (2 ha) or less.*
3. *It is installed where the sediment trap will be used less than 18 months.*
4. *The sediment trap may be constructed either independently or in conjunction with **TEMPORARY DIVERSION BERM** (Chapter 4).*

Planning Considerations

The sediment trap should be located to obtain the maximum storage benefit from the terrain, for ease of cleaning out and disposing of the trapped sediment and to minimize interference with construction activities.

Sediment traps should be used only for small drainage areas. If the contributing drainage area is greater than 5 acres (2 ha), refer to **Temporary Sediment Basin** (listed under **PERIMETER CONTROLS** in **Chapter 4**).

Sediment must be periodically removed from the trap. Plans should detail how this sediment is to be disposed of, such as by use in fill areas onsite or removal to an approved offsite dump.

Sediment traps, along with other perimeter controls, shall be installed before any land disturbance takes place in the drainage area.

Design Criteria

Trap Capacity

The sediment trap must have an initial storage volume of 134 cubic yards, or 3,600 cubic feet per acre (252 m³/ha) of drainage area, measured from the low point of the ground to

the crest of the gravel outlet. Sediment should be removed from the basin when the volume is reduced by one-half.

For a natural basin, the volume may be approximated as follows:

$$V = 0.4 \times A \times D$$

where:

V = the storage volume in cubic feet (ft³).

A = the surface area of the flood area at the crest of the outlet, in square feet (ft²).

D = the maximum depth, measured from low point in trap to crest of outlet, in ft.

Excavation

If excavation is necessary to attain the required storage volume, the side slopes should be no steeper than 2:1.

Embankment Cross-Section

The maximum height of the sediment trap embankment shall be 5 feet (1.5 m) as measured from the low point. **Table 4.2** shows minimum top widths (W) and outlet heights (Ho) for various embankment heights (H). The side slopes of the embankment shall be 2:1 or flatter.

Table 4.2. Minimum Top Width (W) and Outlet Height (Ho) Required for Sediment Trap Embankment According to Height of Embankment (feet)

H	Ho	W
2.0	1.0	2.0
2.5	1.5	2.5
3.0	2.0	2.5
3.5	2.5	3.0
4.0	3.0	3.0
4.5	3.5	4.0
5.0	4.0	4.5

Outlet

The outlets shall be designed, constructed, and maintained so that sediment does not leave the trap and erosion of the outlet does not occur. A trap may have several different outlets, with each outlet conveying part of the flow based on the criteria below. The combined outlet capacity shall be sufficient for the drainage area. For example, a 12 foot (3.6 m) earth outlet, adequate for 2 acres (0.8 ha), and a 12 inch (30 cm) pipe outlet, adequate for 1 acre (0.4 ha), could be used for a 3 acre (1.2 ha) drainage area.

There are four types of outlets for sediment traps. Each sediment trap is named according to the type of outlet that it has. Each type has different design criteria and will be discussed separately. The types are as follows:

1. **An Earth Outlet Sediment Trap** consists of a basin formed by excavation and/or an embankment. The trap has a discharge point over or cut into natural ground. The outlet width (feet) shall be equal to 6 times the drainage area (acres). If an embankment is used, the outlet crest shall be at least 1 foot (30 cm) below the top of the embankment. The outlet shall be free of any restriction to flow. The earthen embankment shall be seeded with temporary or permanent vegetation (see **Chapter 7**) within 15 days of construction (see **Figure 4.6a**).
2. **A Pipe Outlet Sediment Trap** consists of a basin formed by an embankment, or an excavation and an embankment. The outlet for the trap is through a perforated riser and a pipe through the embankment. The outlet pipe and riser shall be made of corrugated metal. The riser diameter shall be of the same or larger diameter than the pipe. The top of the embankment shall be at least 1½ feet (45 cm) above the crest of the riser. At least the top two-thirds of the riser shall be perforated with ½ inch (13 mm) diameter holes spaced 8 inches (20 cm) vertically and 10 to 12 inches (25 to 30 cm) horizontally. All pipe connections shall be watertight (see **Figure 4.6b**). Select the pipe diameter from the specifications listed in **Table 4.3**.

Table 4.3. Minimum Pipe Diameter for Pipe Outlet Sediment Trap According to Maximum Size of Drainage Area

Minimum Pipe Diameter in Inches (cm)	Maximum Drainage Area in Acres (ha)
12 (30 cm)	1 (0.4 ha)
18 (45 cm)	2 (0.8 ha)
21 (53 cm)	3 (1.2 ha)
24 (60 cm)	4 (1.6 ha)
30 (75 cm)	5 (2.0 ha)

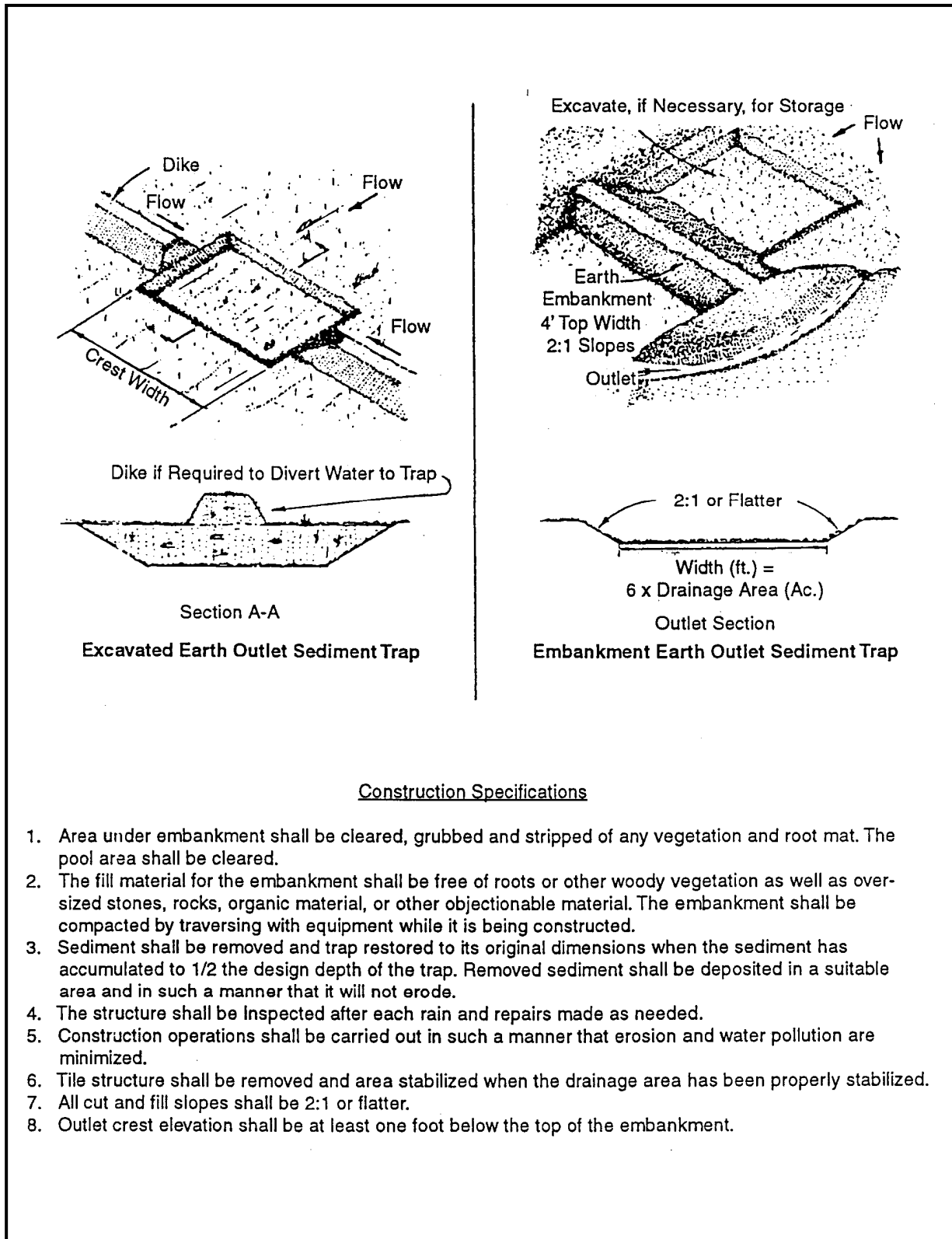

Construction Specifications

1. Area under embankment shall be cleared, grubbed and stripped of any vegetation and root mat. The pool area shall be cleared.
2. The fill material for the embankment shall be free of roots or other woody vegetation as well as oversized stones, rocks, organic material, or other objectionable material. The embankment shall be compacted by traversing with equipment while it is being constructed.
3. Sediment shall be removed and trap restored to its original dimensions when the sediment has accumulated to 1/2 the design depth of the trap. Removed sediment shall be deposited in a suitable area and in such a manner that it will not erode.
4. The structure shall be inspected after each rain and repairs made as needed.
5. Construction operations shall be carried out in such a manner that erosion and water pollution are minimized.
6. The structure shall be removed and area stabilized when the drainage area has been properly stabilized.
7. All cut and fill slopes shall be 2:1 or flatter.
8. Outlet crest elevation shall be at least one foot below the top of the embankment.

Figure 4.6a. Earth Outlet Sediment Trap

Source: NRCS

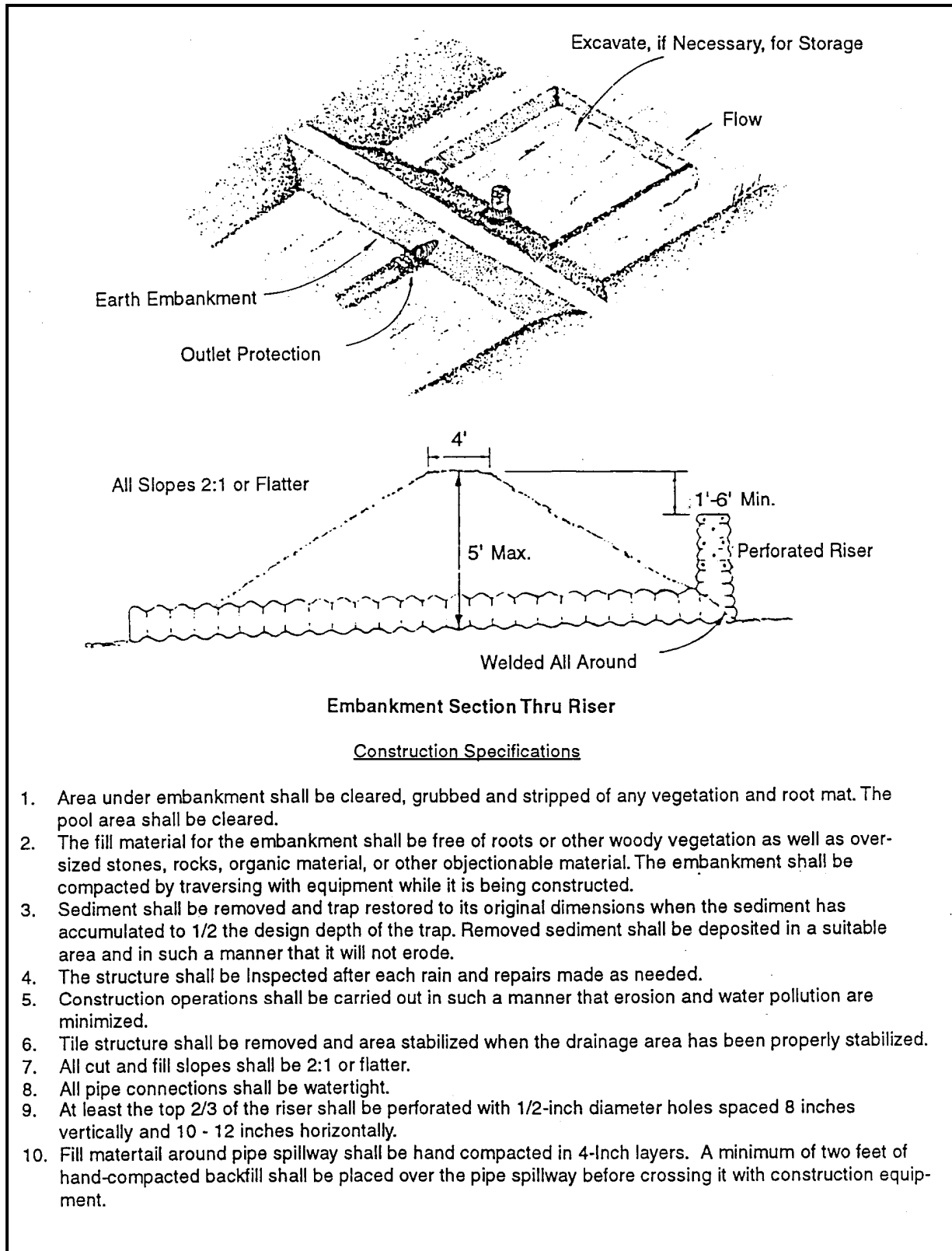
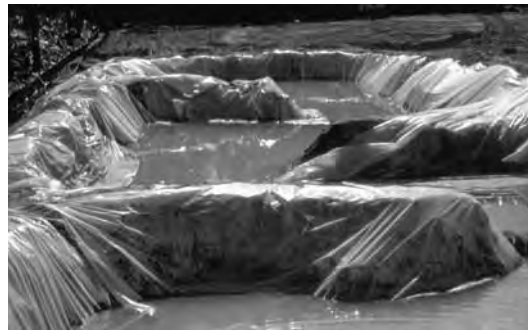

Figure 4.6b. Pipe Outlet Sediment Trap

Source: NRCS

3. **A Stone Outlet Sediment Trap** consists of a basin formed by an embankment or excavation and an embankment. The outlet for the sediment trap shall consist of a crushed stone section of the embankment located at the low point in the basin. The minimum length of the outlet shall be 6 feet times the acreage of the drainage area (4.5 m x ha). The crest of the outlet must be at least 1 foot (30 cm) below the top of the embankment, to ensure that the flow will travel over the stone and not the embankment. The outlet shall be constructed of FDOT No. 1 size crushed stone (see **Figure 4.6c**).
4. **A Storm Inlet Sediment Trap** consists of a basin formed by excavation or natural ground that discharges through an opening in a storm drain inlet structure. This opening can either be the inlet opening or a temporary opening made by omitting bricks or blocks in the inlet. The trap shall be between 1 and 2 feet (30 to 60 cm) deep, measured from the low point of the inlet. A yard drain inlet or an inlet in the median strip of a dual highway would use the inlet opening for an outlet (see **Figure 4.6e**). A curb inlet would require a temporary opening (see **Figure 4.6f**). The trap should be out of the roadway to avoid interference with construction. Placing the trap on the opposite side of the opening and diverting water from the roadway to the trap is one means of accomplishing this.
5. **Other Applications.** At times a small trap may be constructed in a drainage channel using the culvert for a road crossing. Straw bales or gravel-filled bags may be used, provided that there are no gaps in the installation (see **Figures 4.6g** and **4.6h**). In larger traps, baffles may be required to ensure adequate flow length and prevent short-circuiting).



Construction Specifications

1. The area under the embankment shall be cleared, grubbed, and stripped of any vegetation and root mat. To facilitate cleanout, the pool area should be cleared.
2. Fill material for the embankment shall be free of roots or other woody vegetation, organic material, large stones, and other objectionable material. The embankment should be compacted in 8 inch (20 cm) layers by traversing it with construction equipment.
3. The earthen embankment shall be seeded with temporary or permanent vegetation (see **Chapter 7**) within 15 days of construction.
4. Construction operations shall be carried out so that erosion and water pollution are minimized.
5. The structure shall be removed and the area stabilized when the upslope drainage area has been stabilized.

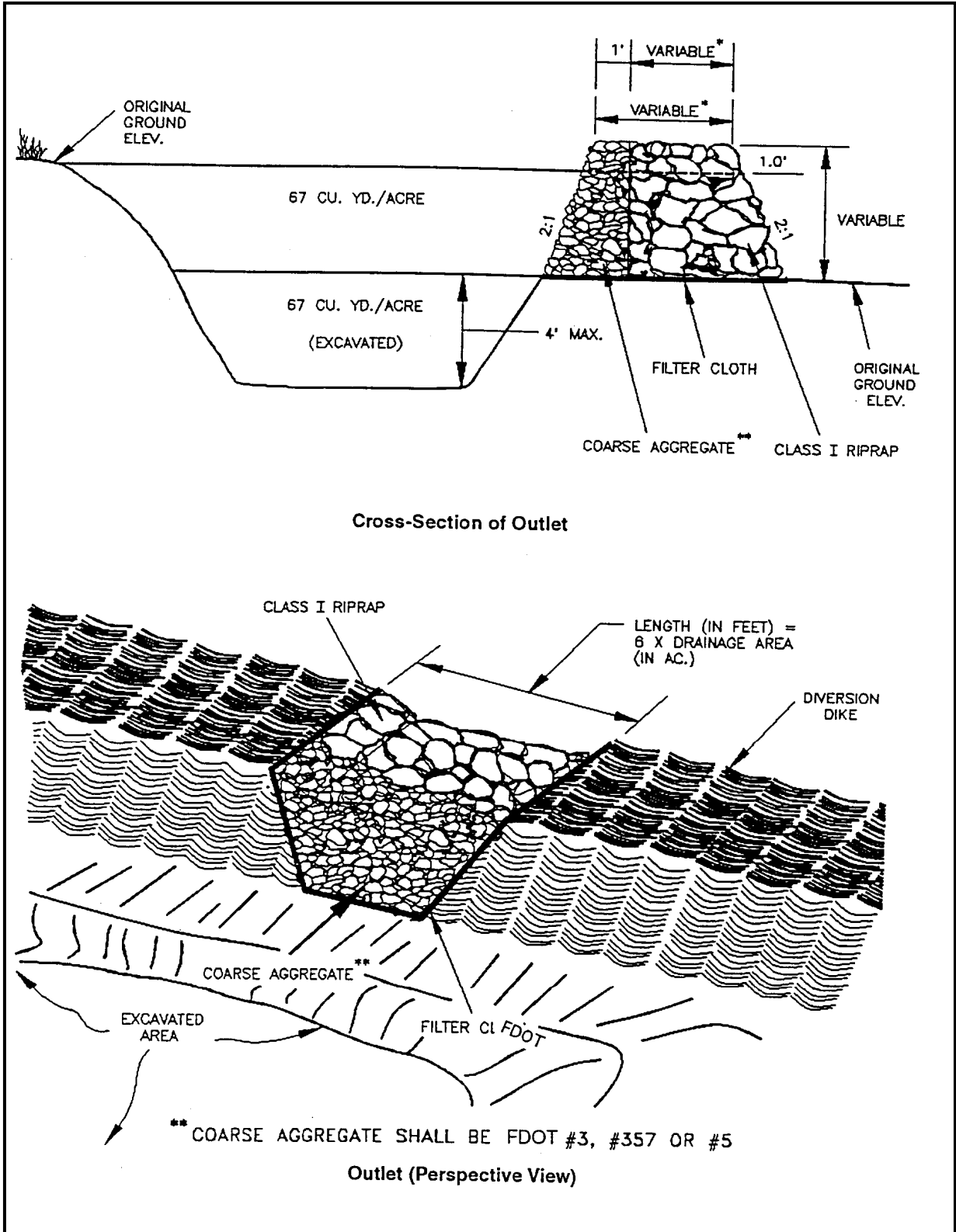

Figure 4.6c. Stone Outlet Sediment Trap

Source: NRCS

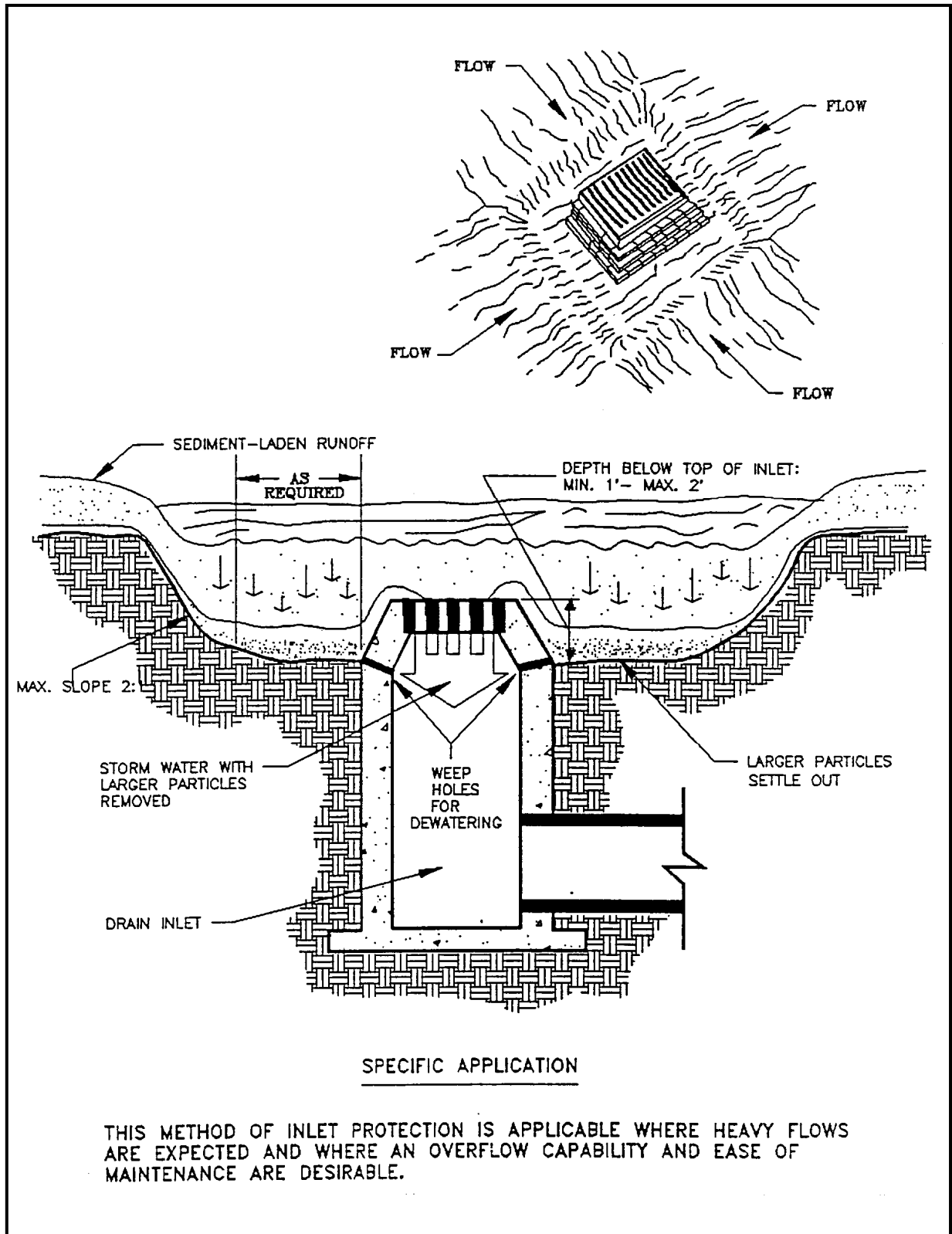

Figure 4.6e. Excavated Drop Inlet Sediment Trap

Source: Michigan Soil Erosion and Sedimentation Control Guidebook

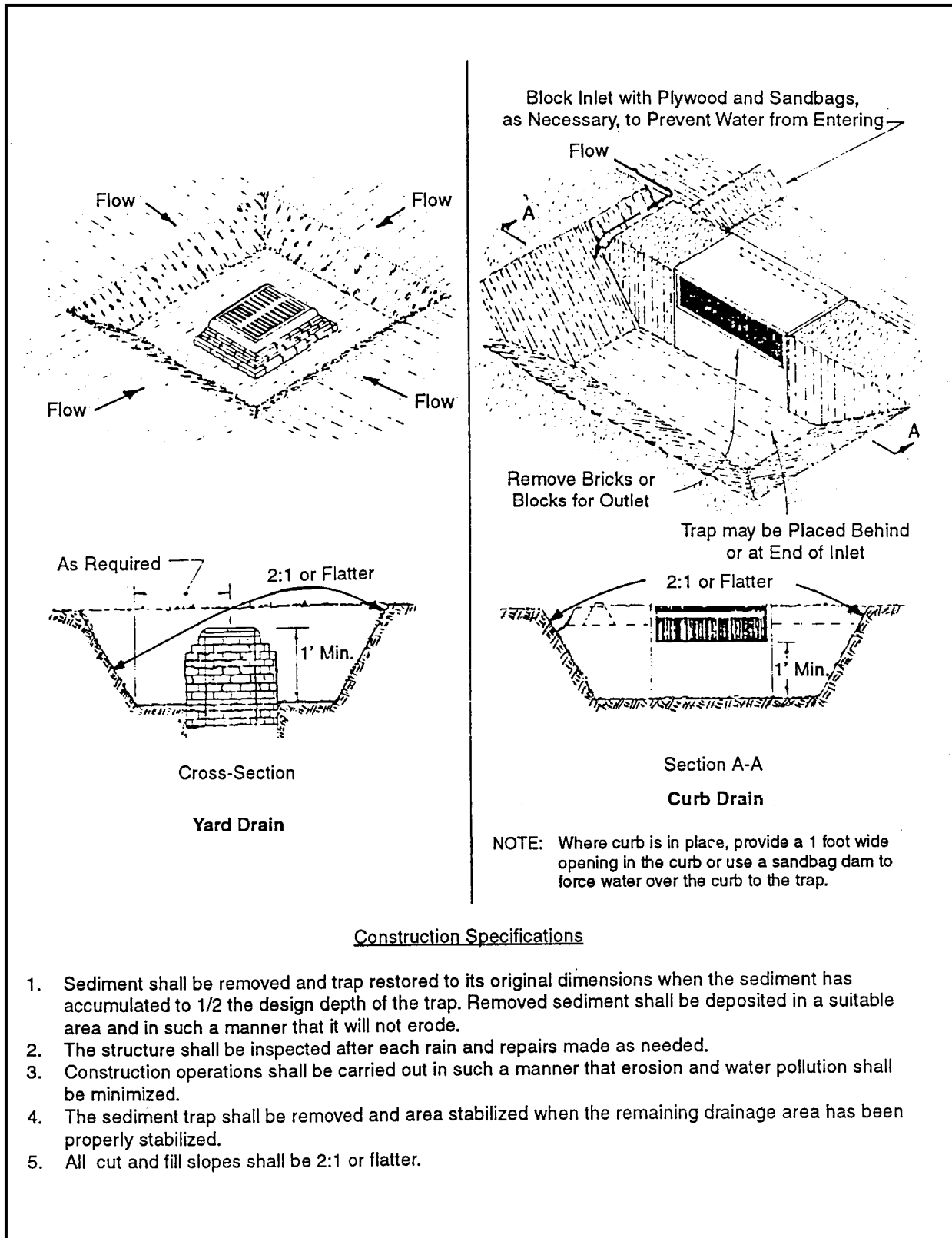

Figure 4.6f. Storm Inlet Sediment Trap

Source: NRCS

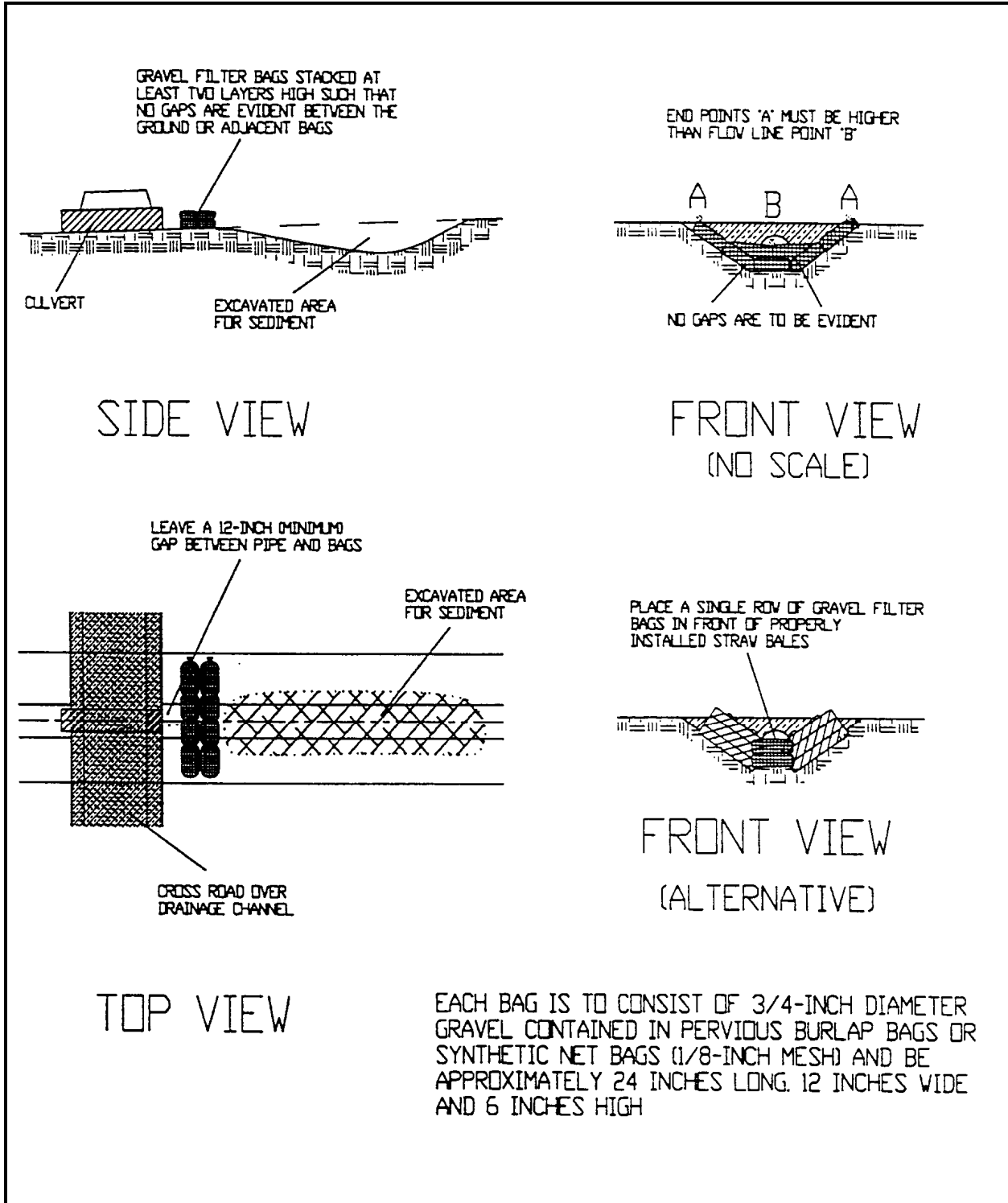

Figure 4.6g. Small Sediment Trap Located in a Stormwater Conveyance Channel

Source: HydroDynamics, Inc.

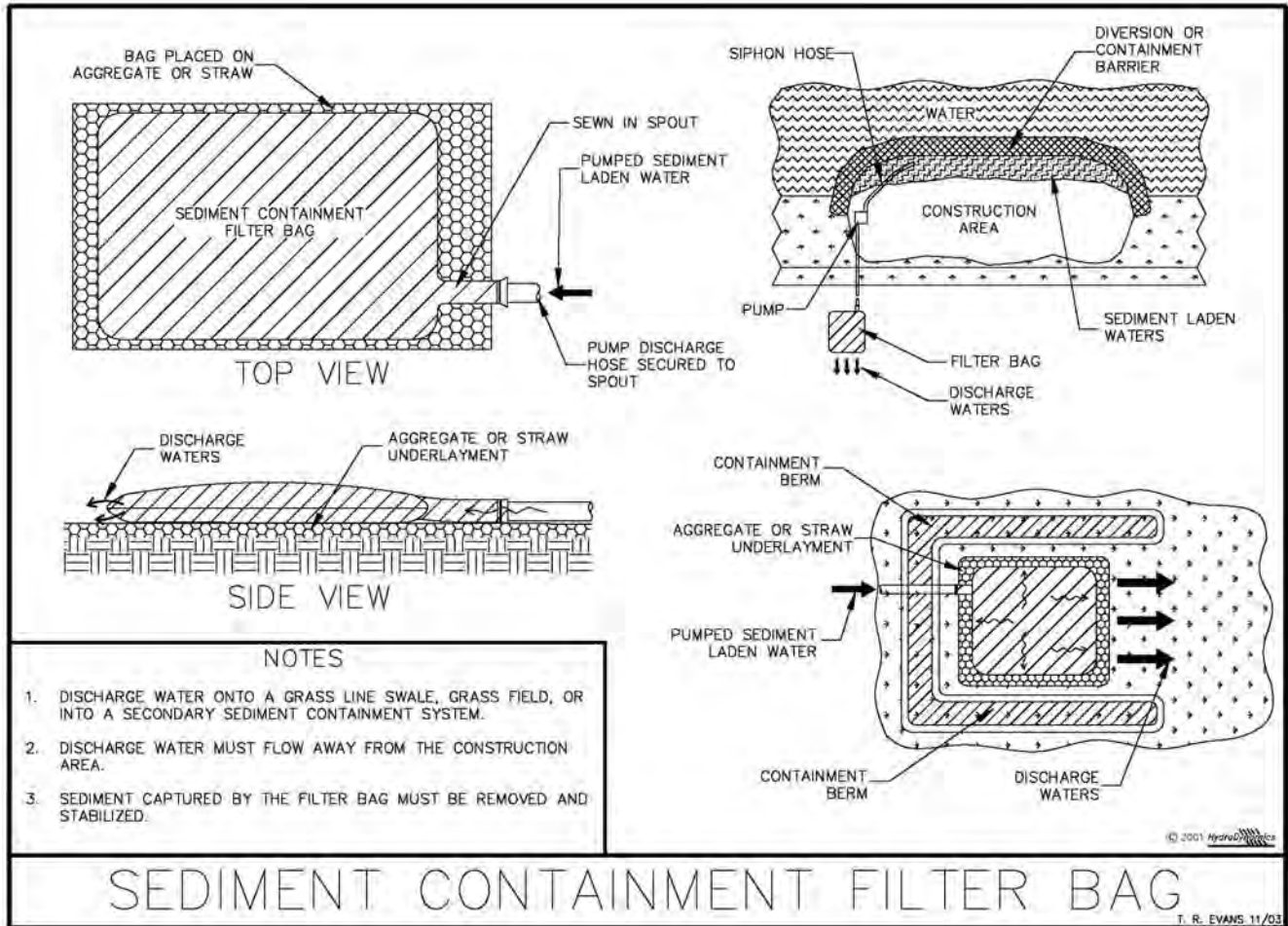

Figure 4.6h. Sediment Containment Filter Bag

Maintenance

1. Sediment shall be removed and the trap restored to its original dimensions when the sediment has accumulated to one-half the design volume of the trap. Sediment removed from the basin shall be deposited in a suitable area and in such a manner that it will not erode.
2. The structure should be checked regularly to ensure that it is structurally sound and has not been damaged by erosion or construction equipment. The height of the outlet should be checked to ensure that its center is at least 1 foot (30 cm) below the top of the embankment.

Removal

Sediment traps must be removed after the contributing drainage area is stabilized. Plans should show how the site of the sediment trap is to be graded and stabilized after removal.

4.7 Temporary Sediment Basin

Definition

A temporary basin with a controlled stormwater release structure, formed by constructing an embankment of compacted soil across a drainageway.

Purpose

To detain sediment-laden runoff from disturbed areas long enough for most of the sediment to settle out.

Conditions Where Practice Applies

Suggested for drainage areas greater than 5 acres (2 ha). There must be sufficient space and appropriate topography for the construction of a temporary impoundment. These structures are limited to a useful life of 18 months unless they are designed as permanent ponds by a qualified professional engineer.

Planning Considerations

Effectiveness

Sediment basins are at best only 70 to 80% effective in trapping sediment that flows into them. Therefore, they should be used together with erosion control practices such as temporary seeding, mulching, diversion berms, etc., to reduce the amount of sediment flowing into the basin.

Location

To improve the effectiveness of the basin, it should be located so as to intercept the largest possible amount of runoff from the disturbed area. The best locations are generally low areas and natural drainageways below disturbed areas. Drainage into the basin can be improved by the use of diversion berms and ditches. The basin must not be located in a live stream but should be located to trap sediment-laden runoff **BEFORE** it enters the stream. The basin should not be located where its failure would result in the loss of life, damage to adjacent properties, or interruption of the use of public utilities or roads.

Multiple Use

Sediment basins may be designed as permanent structures to remain in place after construction is completed. The Stormwater Rule (Rule 62-25, F.A.C.) makes the use of these structures desirable for stormwater detention purposes. Always leave the bottom of the sediment basin 6 to 12 inches higher than the eventual bottom of a retention basin. This will ensure the removal of accumulated fine sediments that could prematurely clog the retention basin. Wherever these structures are to become permanent, or if they exceed the size limitations of the design criteria, they must be designed as permanent ponds by a qualified professional engineer. Permanent ponds are beyond the scope of this BMP.

Design Criteria

Maximum Drainage Area

Unless the structure is designed as a permanent pond by a qualified professional engineer, the maximum allowable drainage area into the basin shall be 150 acres (61 ha).

Basin Capacity

The design capacity of the basin must be at least 134 cubic yards or 3,600 cubic feet per acre (252 m³/ha) of drainage area measured from the bottom of the basin to the crest of the principal spillway (riser pipe). Sediment should be removed from the basin when the volume of the basin has been reduced to 55 cubic yards per acre (104 m³/ha) of drainage area. The elevation of the sediment cleanout level should be calculated and clearly marked on the riser. In no case shall the sediment cleanout level be higher than 1 foot (30 cm) below the top of the riser (see **Figure 4.7a**).

Basin Shape

To improve the sediment-trapping efficiency of the basin, the effective flow length must be twice the effective flow width. This basin shape may be attained by properly selecting the site of the basin, by excavation, or by the use of baffles (see **Figure 4.7b**). See Appendix 1.26A of the *Florida Development Manual* for design details.

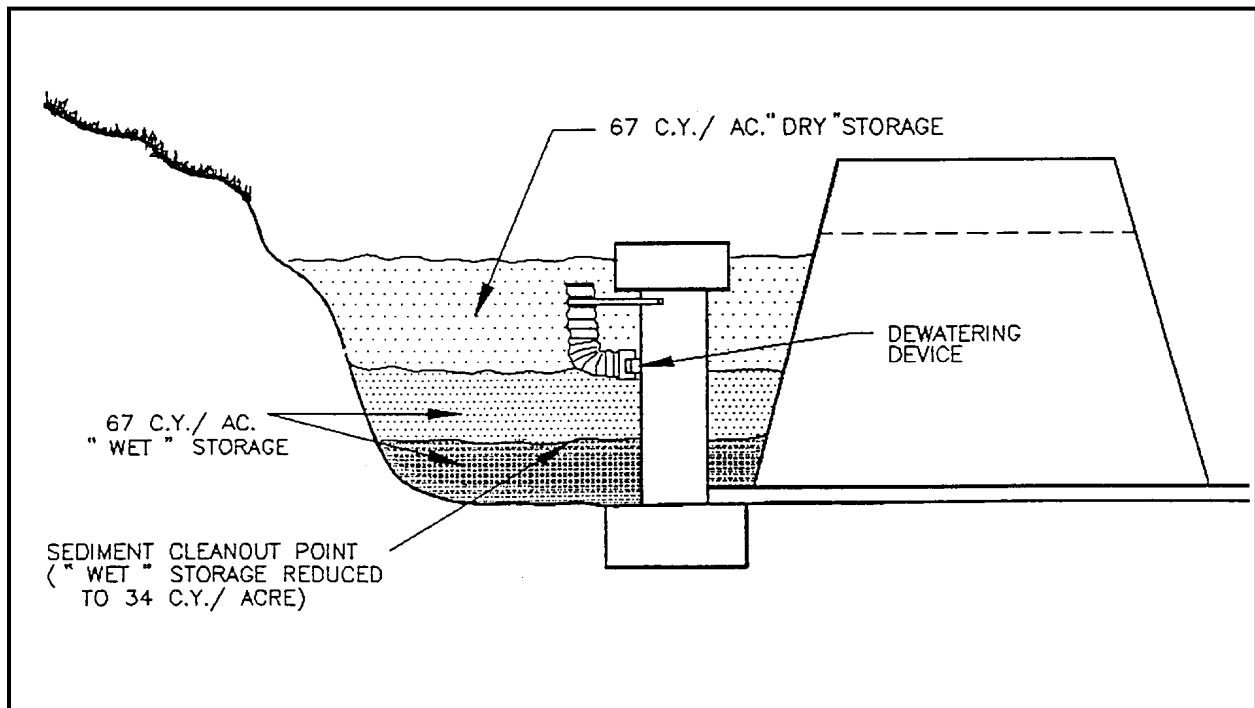

Figure 4.7a. Sediment Basin Storage Volumes

Source: Virginia DSWC

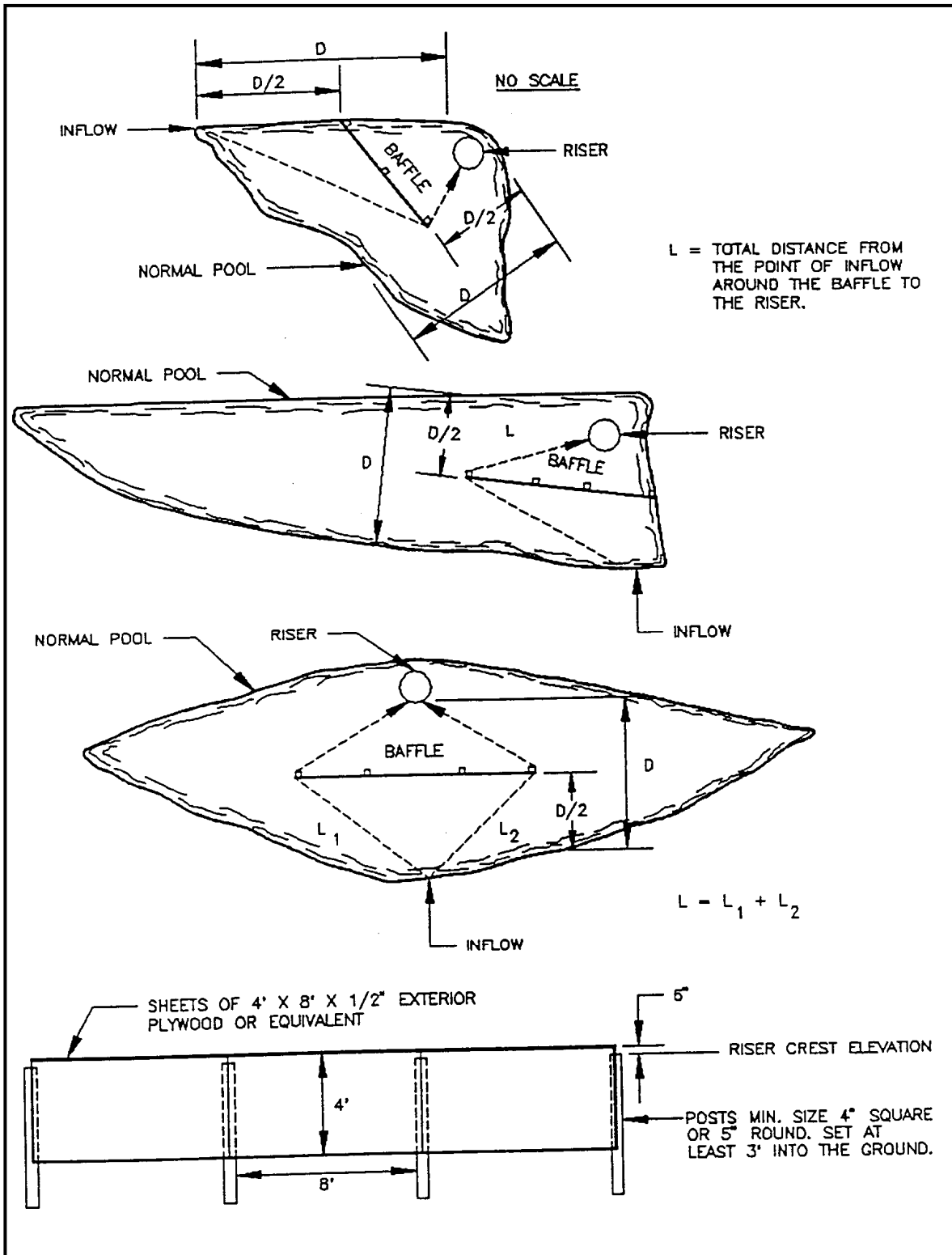

Figure 4.7b. Sample Plan View of Baffle Locations in Sediment Basins

Embankment Cross-Section

The embankment must have a minimum top width of 8 feet (2.5 m). The side slopes must be 2:1 or flatter. The embankment may have a maximum height of 10 feet (3 m) if the side slopes are 2:1. If the side slopes are 2.5:1 or flatter, the embankment may have a maximum height of 15 feet (4.5 m).

Spillway Design

The outlets for the basin may consist of a combination of principal and emergency spillways or a principal spillway alone. In either case, the outlet(s) must pass the peak runoff expected from the drainage area for a ten-year storm without damage to the embankment of the basin. Runoff computations shall be based on the soil cover conditions that are expected to prevail during the life of the basin.

The spillways designed by the procedures contained in this BMP will **NOT** necessarily result in any reduction in the peak rate of runoff. If a reduction in peak runoff is needed, the appropriate hydrographs should be generated to choose the basin and outlet sizes.

To increase the efficiency of the basin, the spillway(s) must be designed to maintain a permanent pool of water between storm events.

Principal Spillway

The principal spillway shall consist of a solid (non-perforated), vertical pipe or box of corrugated metal or reinforced concrete joined by a watertight connection to a horizontal pipe (barrel) extending through the embankment, with an outlet beyond the downstream toe of the fill. If the principal spillway is used in conjunction with an emergency spillway, the principal spillway shall have a minimum capacity of 0.2 cfs per acre (0.015 m³/sec per ha) of drainage area when the water surface is at the crest of the emergency spillway. If no emergency spillway is used, the principal spillway must be designed to pass the entire peak flow expected from a 10-year storm. See Appendix 1.26A of the *Florida Development Manual* for design details.

Design Elevations

If the principal spillway is used together with an emergency spillway, the crest of the principal spillway shall be a minimum of 1 foot (30 cm) below the crest of the emergency spillway. If no emergency spillway is used, the crest of the principal spillway shall be a minimum of 3 feet (90 cm) below the top of the embankment (see **Figure 4.7c**). In either case, a minimum freeboard of 1 foot (30 cm) shall be provided between the design high water and the top of the embankment.

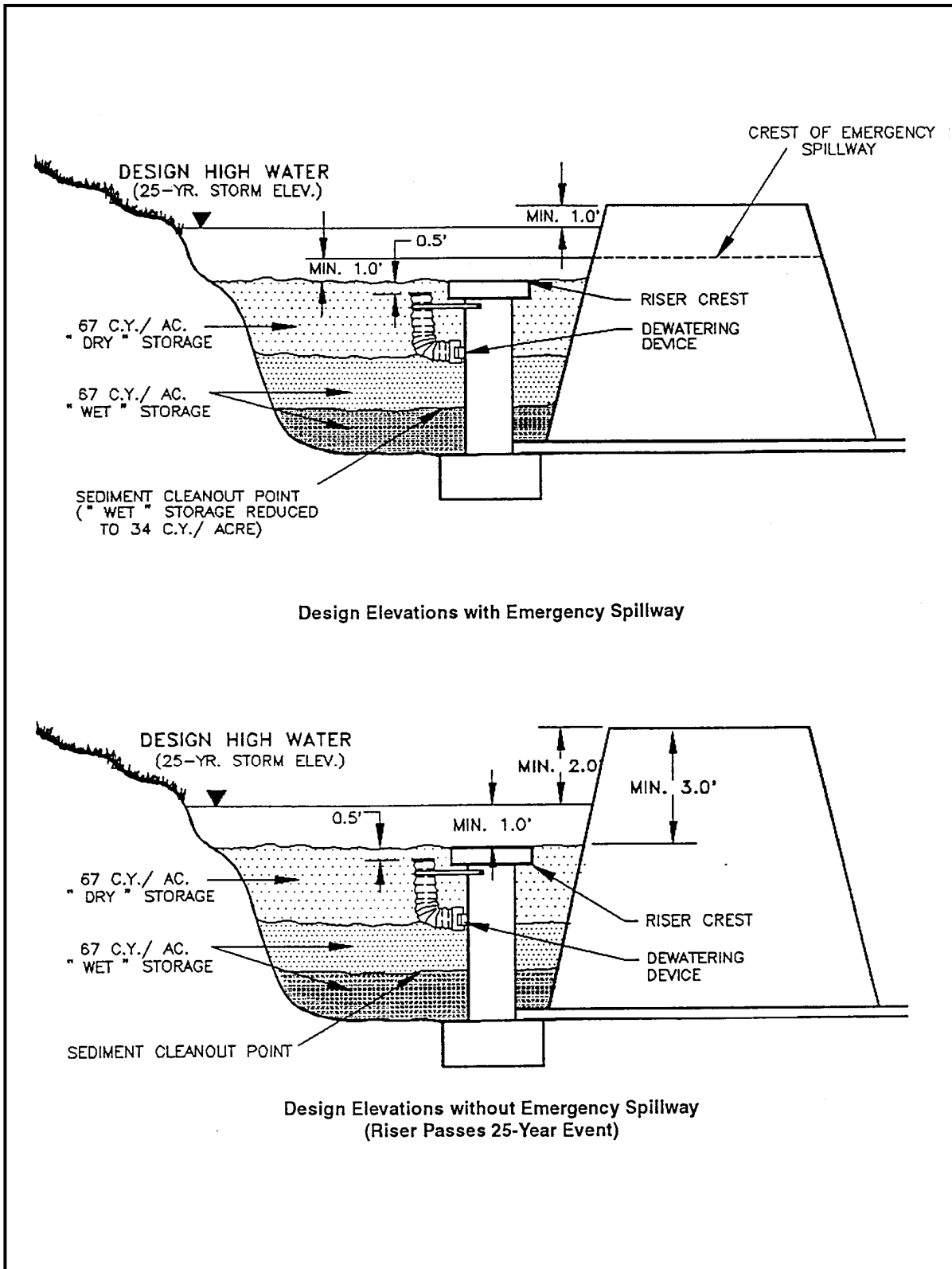

Figure 4.7c. Sediment Basin Schematic Elevations

Source: Virginia DSWC

Antivortex Device and Trash Rack

An antivortex device and trash rack shall be attached to the top of the principal spillway to improve the flow of water into the spillway and prevent floating debris from being carried out of the basin. The antivortex device shall be of the concentric type (see **Figure 4.7c**). See Appendix 1.26A of the *Florida Development Manual* for design procedures for the antivortex device and trash rack.

Dewatering

Dewatering shall be done in a way that removes the relatively clean water without removing any of the sediment that has settled out and without removing any appreciable quantities of floating debris. As a minimum, provisions shall be made to dewater the basin down to the sediment cleanout elevation. This can be accomplished by providing a hole at the maximum sediment retention elevation (see **Figure 4.7c**). The dewatering hole shall be no larger than 4 inches (10 cm) in diameter. **Chapter 5** outlines other means of dewatering.

It is also advantageous (but not required) to provide for dewatering of trapped sediment before cleanout. Basin underdrains are generally installed for this purpose.

Base

The base of the principal spillway must be firmly anchored to prevent it from floating. If the riser of the spillway is greater than 10 feet (3 m) in height, computations must be made to determine the anchoring requirements. As a minimum, a factor of safety of 1.25 shall be used (downward forces = 1.25 x upward forces).

For risers 10 feet (3 m) or less in height, the anchoring may be done in one of the two following ways:

1. A concrete base 18 inches (45 cm) thick and twice the width of riser diameter shall be used and the riser embedded 6 inches (15 cm) into the concrete (see **Figure 4.7e** and Appendix 1.26A of the *Florida Development Manual* for design details).
2. A square steel plate, a minimum of ¼ inch (6.5 mm) thick and having a width equal to twice the diameter of the riser, shall be welded to the base of the riser. The plate shall then be covered with 2½ feet (76 cm) of stone, gravel, or compacted soil to prevent flotation.

Barrel

The barrel of the principal spillway, which extends through the embankment, shall be designed to carry the flow provided by the riser of the principal spillway with the water level at the crest of the emergency spillway. The connection between the riser and the barrel must be watertight. The outlet of the barrel must be protected to prevent erosion or scour of downstream areas.

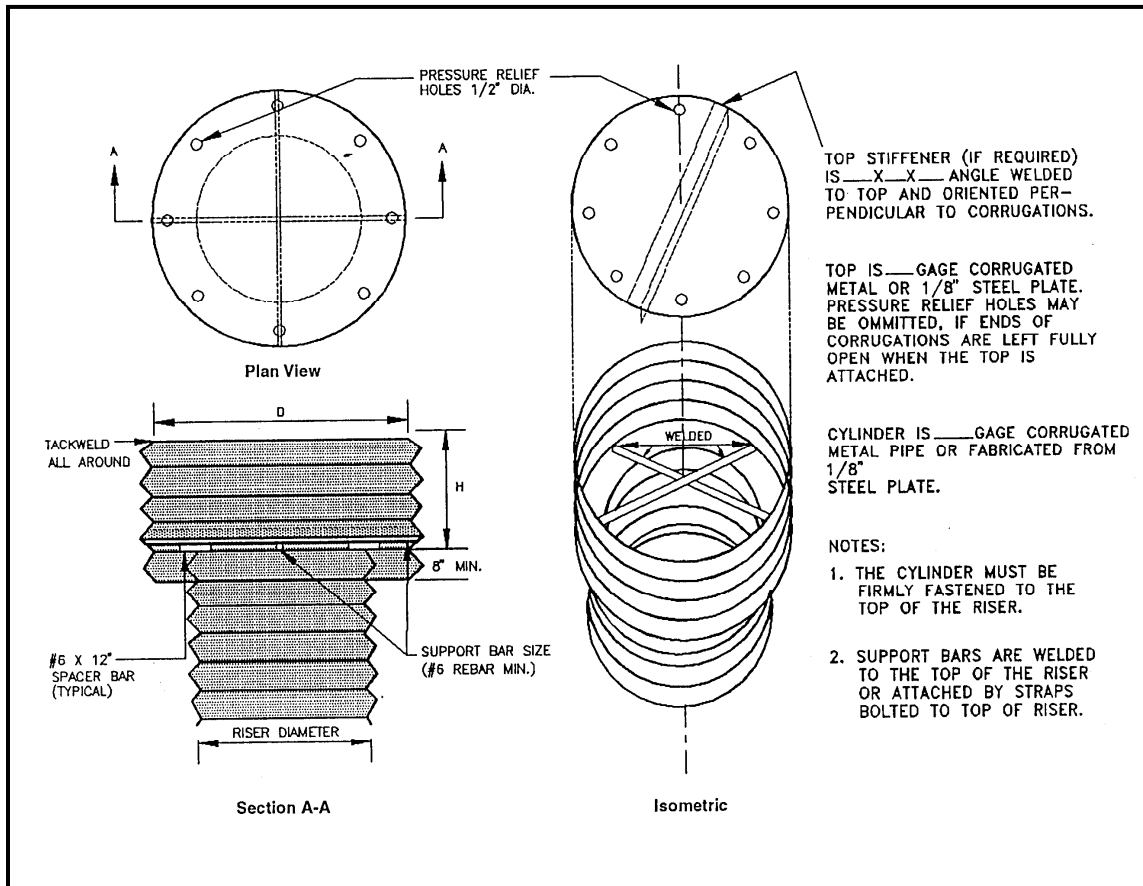

Figure 4.7d. Antivortex Device Design

Source: NRCS

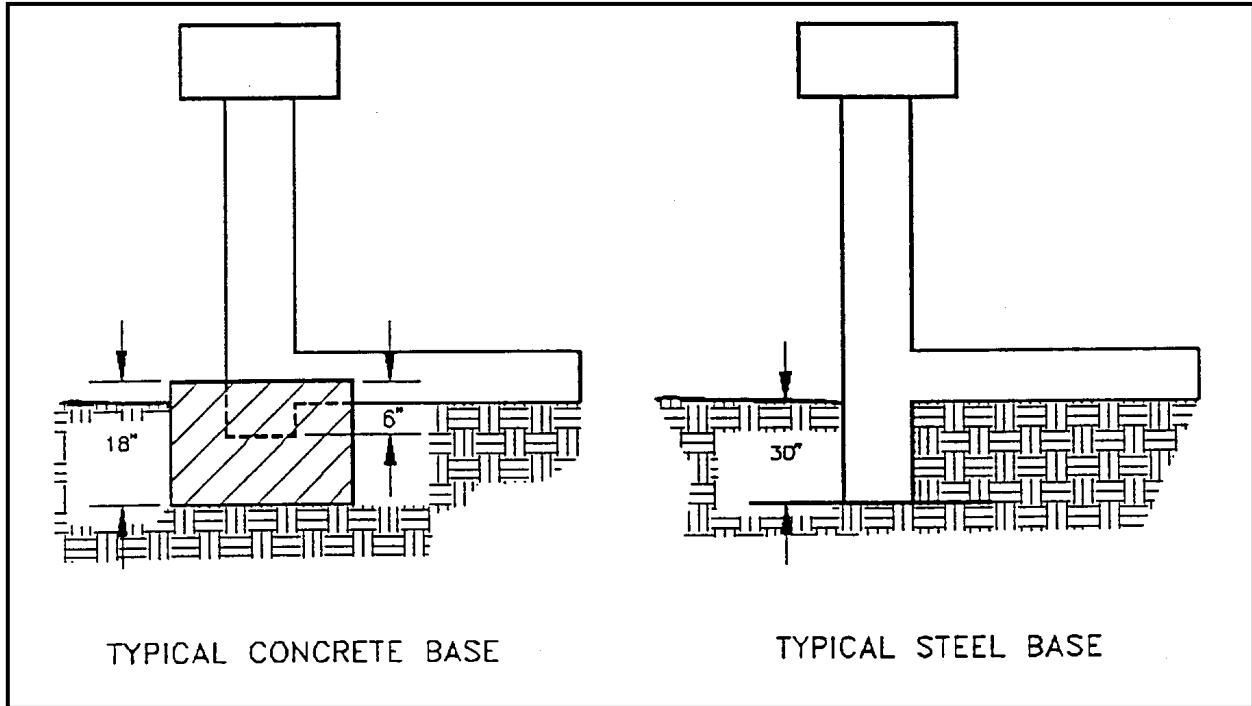

Figure 4.7e. Riser Pipe Conditions

Source: Virginia DSWC

Anti-seep Collars

Anti-seep collars shall be used on the barrel of the principal spillway within the normal saturation zone of the embankment to increase the seepage length by at least 10%, if either of the following two conditions is met:

1. The settled height of the embankment exceeds 10 feet (3 m), and
2. The embankment has a low silt-clay content (Unified Soil Classes SM or GM) and the barrel is greater than 10 inches (25 cm) in diameter.

The Anti-seep collars shall be installed within the saturated zone. The maximum spacing between collars shall be 14 times the projection of the collar above the barrel. Collars shall not be closer than 2 feet (60 cm) to a pipe joint. Collars should be placed sufficiently far apart to allow space for hauling and compacting equipment. Connections between the collars and the barrel shall be watertight (see **Figure 4.7f** and Appendix 1.26A of the *Florida Development Manual* for design procedure and details).

Emergency Spillway

The emergency spillway shall consist of an open channel constructed next to the embankment over undisturbed material or properly compacted fill. The spillway shall have a control section at least 20 feet (6 m) in length. The control section is a level portion of the spillway channel at the highest elevation in the channel (see **Figure 4.7g**). The primary spillway and the emergency spillway shall both discharge to stabilized outlets (see **Figure 4.7h**).

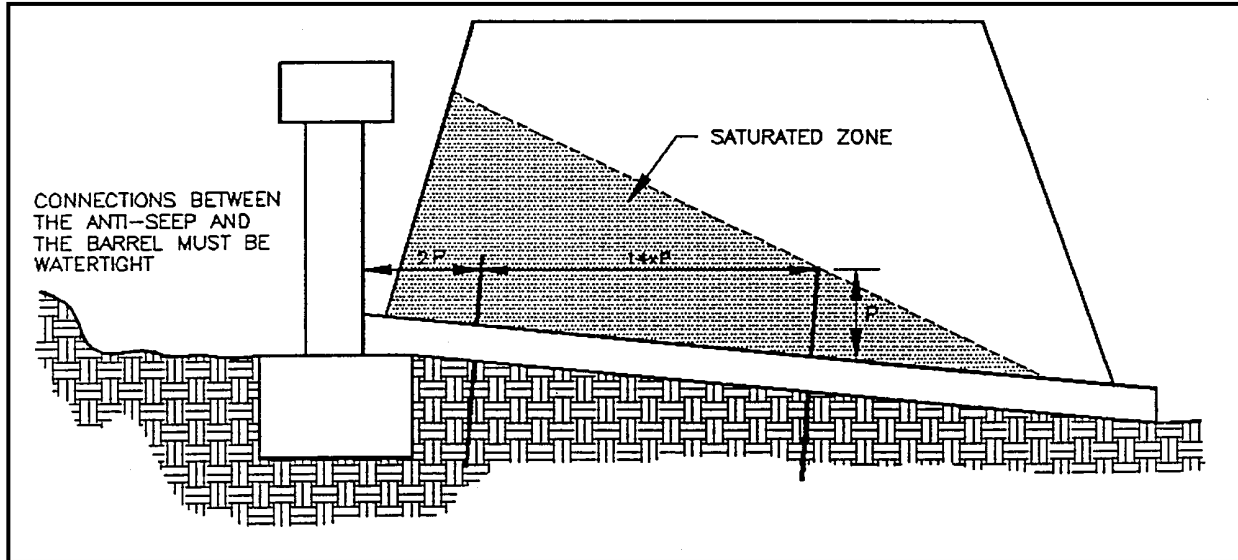

Figure 4.7f. Location of Anti-seep Collars

Source: Virginia DSWC

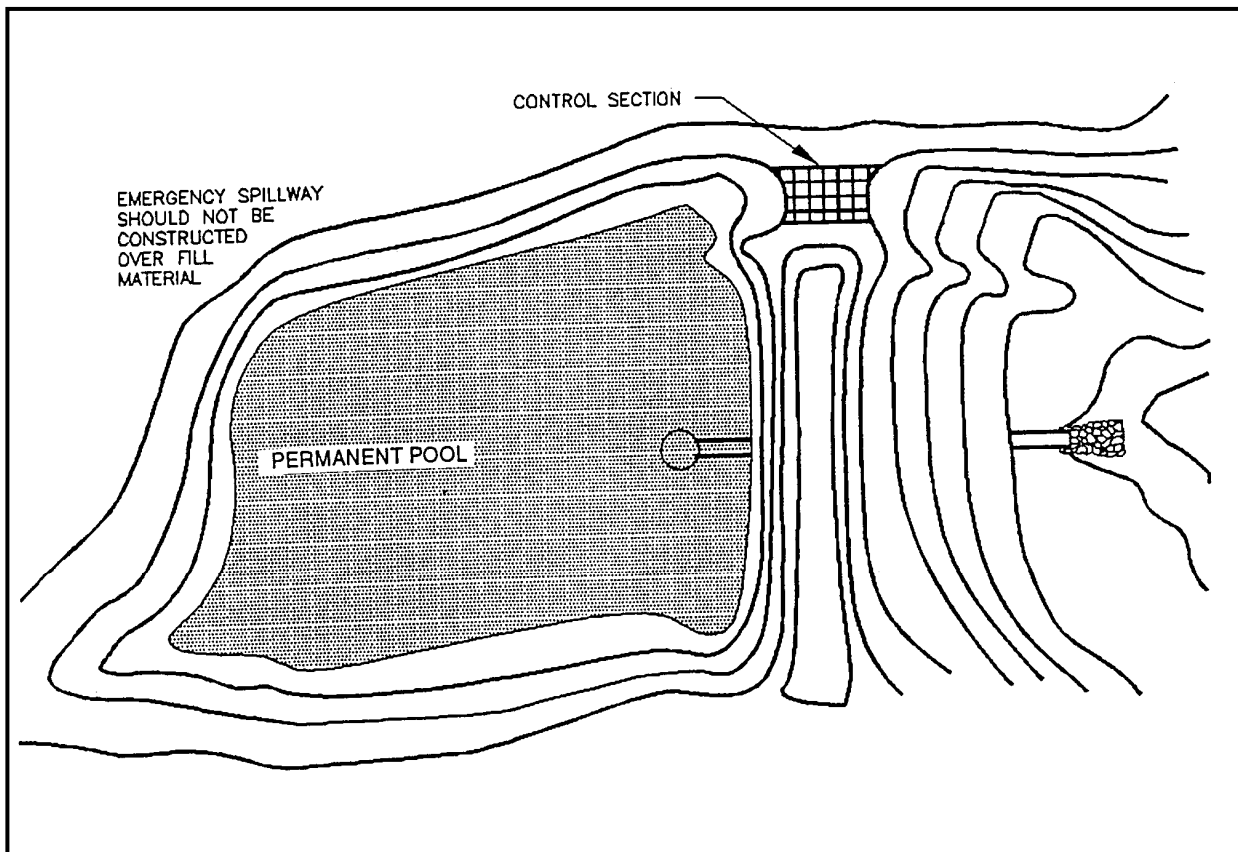

Figure 4.7g. Emergency Spillway

Source: Virginia DSWC

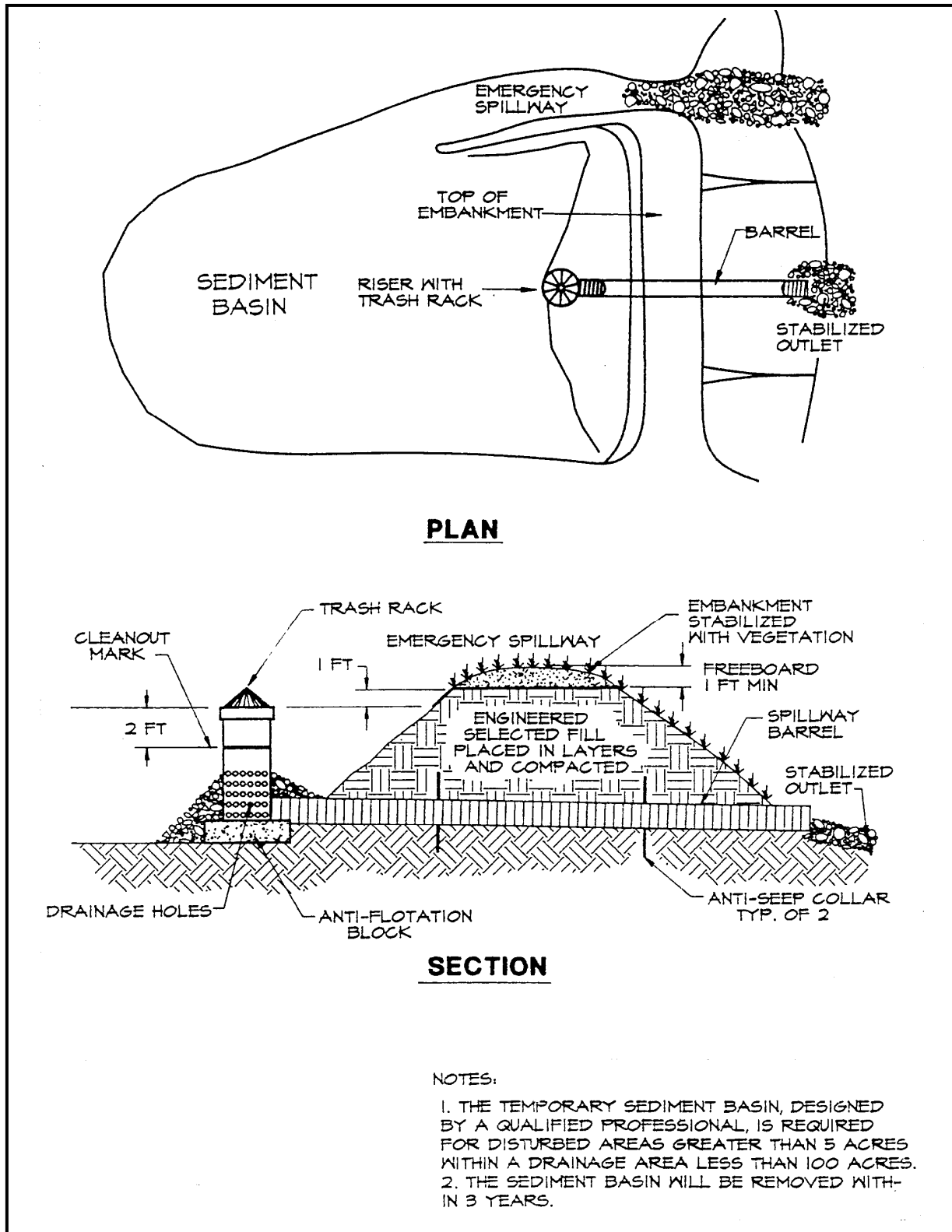

Figure 4.7h. Sediment Basin

Source: Erosion Draw

Capacity

The emergency spillway shall be designed to carry the peak rate of runoff expected from a 10-year storm, less any reduction due to the flow through the principal spillway.

Design Elevations

The design high water through the emergency spillway shall be at least 1 foot (30 cm) below the top of the embankment. The crest of the emergency spillway channel shall be at least 1 foot (30 cm) above the crest of the principal spillway.

Location

The emergency spillway channel shall be located to avoid fill material. If constructed on fill, the fill will be properly compacted in lifts. The channel shall be located so as to avoid sharp turns or bends. The channel shall return the flow of water to a defined channel downstream from the embankment.

Maximum Velocities

The maximum allowable velocity in the emergency spillway channel depends on the type of lining used. For nonerodible linings, such as concrete or asphalt paving and riprap, design velocities may be increased. However, the emergency spillway channel shall return the flow to the natural channel at a noneroding velocity.

Stabilization of the Embankment and Basin

The embankment of the sediment basin shall be temporarily seeded within 15 days after its completion, as described in **TEMPORARY SEEDING (Chapter 7)**. If excavation is required in the basin, side slopes should not be steeper than 2:1.

Cleanout

Sediment shall be removed from the basin when the capacity is reduced to 55 cubic yards per acre (104 m³/ha) of drainage area. This elevation should be clearly marked, preferably on the riser. Plans for the sediment basin shall state the methods for disposing of sediment removed from the basin. Possible alternatives are the use of the material in fill areas onsite or removal to an approved offsite dump.

Final Removal

Sediment basin plans shall show the final disposition of the sediment basin after the upstream drainage area is stabilized. The plans shall specify methods for the removal of excess water lying over the sediment, the stabilization of the basin site, and the disposal of any excess material. Sediment shall not be flushed into the stream or drainageway.

Safety

Sediment basins are attractive to children and can be very dangerous. Therefore, they should be fenced or otherwise made inaccessible to people or animals unless this is deemed unnecessary due to the remoteness of the site or other circumstances. Strategically placed signs around the impoundment reading "DANGER—QUICKSAND" should also be installed. In any case, local ordinances and regulations regarding health and safety must be adhered to.

Construction Specifications

Site Preparation

Areas under the embankment and any structural works shall be cleared, grubbed, and stripped of topsoil to remove trees, vegetation, roots, or other objectionable material. To facilitate cleanout and restoration, the pool area (measured at the top of the principal spillway) will be cleared of all brush and trees.

Cutoff Trench

For earth fill embankments, a cutoff trench shall be excavated along the centerline of the dam. The minimum depth shall be 2 feet (60 cm). The cutoff trench shall extend up both abutments to the riser crest elevation. The minimum bottom width shall be 4 feet (1.2 m), but wide enough to allow the operation of compaction equipment. The side slopes shall be no steeper than 1:1. Compaction requirements shall be the same as those for the embankment. The trench shall be drained during the backfilling and compacting operations.

Embankment

The fill material shall be taken from approved borrow areas. It shall be clean mineral soil, free of roots, woody vegetation, oversized stones, rocks, or other objectionable material. Areas on which fill is to be placed shall be scarified prior to the placement of fill. The fill material should contain sufficient moisture so that it can be formed by hand into a ball without crumbling. If water can be squeezed out of the ball, it is too wet for proper compaction. Fill material will be placed in 6 to 8 inch (15 to 20 cm) continuous layers over the entire length of the fill. Compaction shall be obtained by routing the hauling equipment over the fill so that the entire surface of the fill is traversed by at least 1 wheel or tread track of the equipment, or by using a compactor. The embankment shall be constructed to an elevation 10% higher than the design height to allow for settlement if compaction is obtained with hauling equipment. If compactors are used for compaction, the overbuild may be reduced to not less than 5%.

Principal Spillway

The riser of the principal spillway shall be securely attached to the barrel by a watertight connection. The barrel and riser shall be placed on a firm, compacted soil foundation. The base of the riser shall be firmly anchored according to design criteria to prevent its floating. Pervious material such as sand, gravel, or crushed stone shall not be used as backfill around the barrel or anti-seep collars. Fill material shall be placed around the pipe in 4 inch (10 cm) layers and compacted by hand at least to the same density as the embankment. A minimum of 2 feet (60 cm) of fill shall be hand-compacted over the barrel before crossing it with construction equipment.

Emergency Spillway

The emergency spillway should not be constructed over fill material. Design elevations, widths, and entrance and exit channel slopes are critical to the successful operation of the spillway and should be adhered to closely during construction.

Vegetative Stabilization

The embankment and emergency spillway of the sediment basin shall be stabilized with temporary vegetation within 15 days of completion of the basin, as described in **TEMPORARY SEEDING (Chapter 7)**.

Erosion and Sediment Control

The construction of the sediment basin shall be carried out in a manner such that erosion and water pollution are minimized downstream.

Final Disposal

When **temporary** structures have served their intended purpose and the contributing drainage area has been properly stabilized, the embankment and resulting sediment deposits are to be leveled or otherwise disposed of according to the approved pollution control plan.

Maintenance

The embankment of the basin should be checked regularly to ensure that it is structurally sound and has not been damaged by erosion or construction equipment. The emergency spillway should be checked regularly to ensure that its lining is well-established and erosion resistant. The basin should be checked after each runoff-producing rainfall for sediment cleanout. When the sediment reaches the cleanout level mark, it shall be removed and properly disposed of.

Information To Be Submitted for Approval

Sediment basin designs and construction plans submitted for review to the appropriate regulatory agency shall include the following:

1. *Specific location of the dam.*
2. *Plan view of dam, storage basin, and emergency spillway.*
3. *Cross-sections and profiles of dam, principal spillway, and emergency spillway.*
4. *Details of pipe connections, riser to pipe connection, riser base, anti-seep collars, trash rack, and antivortex device.*
5. *Runoff calculations for a 10-year frequency storm.*
6. *Storage computations:*
 - a. Total required,
 - b. Total available, and
 - c. Level of sediment at which cleanout shall be required, to be stated as a distance from the riser crest to the sediment surface.
7. *Calculations showing design of pipe and emergency spillway.*

4.8 Temporary Check Dam

Definition

A small, temporary dam constructed across a swale or stormwater conveyance channel.

Purpose

To reduce the velocity of concentrated stormwater flows, thus reducing erosion of the swale or ditch. This practice also traps small amounts of sediment generated in the ditch itself. These sediments require periodic removal. However, this is not a sediment-trapping practice and should not be used as such.

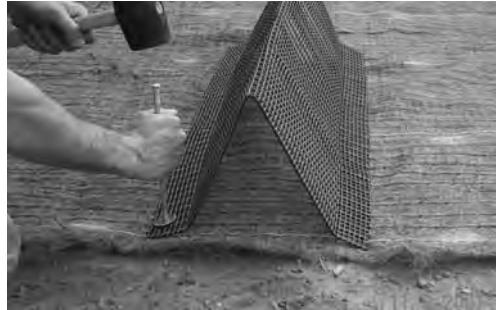

Conditions Where Practice Applies

This practice is limited to use in small, open channels that drain 10 acres (4 ha) or less, and should not be used in a live stream. It is especially applicable to sloping sites where the gradient of waterways is close to the maximum for a grass lining. Some specific applications include the following:

- 1. Temporary ditches or swales that, because of their short length of service, cannot receive a nonerodible lining but still need some protection to reduce erosion.*
- 2. Permanent ditches or swales that for some reason cannot receive a permanent, nonerodible lining for an extended period.*
- 3. Either temporary or permanent ditches or swales that need protection during the establishment of grass linings.*

Planning Considerations

Temporary check dams can be constructed of stone, filter socks, or a variety of prefabricated products.

Construction Specifications

No formal design is required for a temporary check dam; however, a number of criteria should be adhered. The drainage area of the ditch or swale being protected should not exceed 10 acres (4 ha). The maximum height of the check dam should be 2 feet (60 cm). The center of the check dam must be at least 6 inches (15 cm) lower than the outer edges (see **Figure 4.8a**). The maximum spacing between the dams should be

such that the toe of the upstream dam is at the same elevation as the top of the downstream dam (see **Figure 4.8a**).

Stone check dams should be constructed of FDOT No. 1 Coarse Aggregate (1.5 to 3.5 inch) (4 to 9 cm) stone. The stone should be placed according to the configuration in **Figure 4.8b**. Hand or mechanical placement will be necessary to achieve complete coverage of the ditch or swale and to ensure that the center of the dam is lower than the ends (see **Figure 4.8b**).

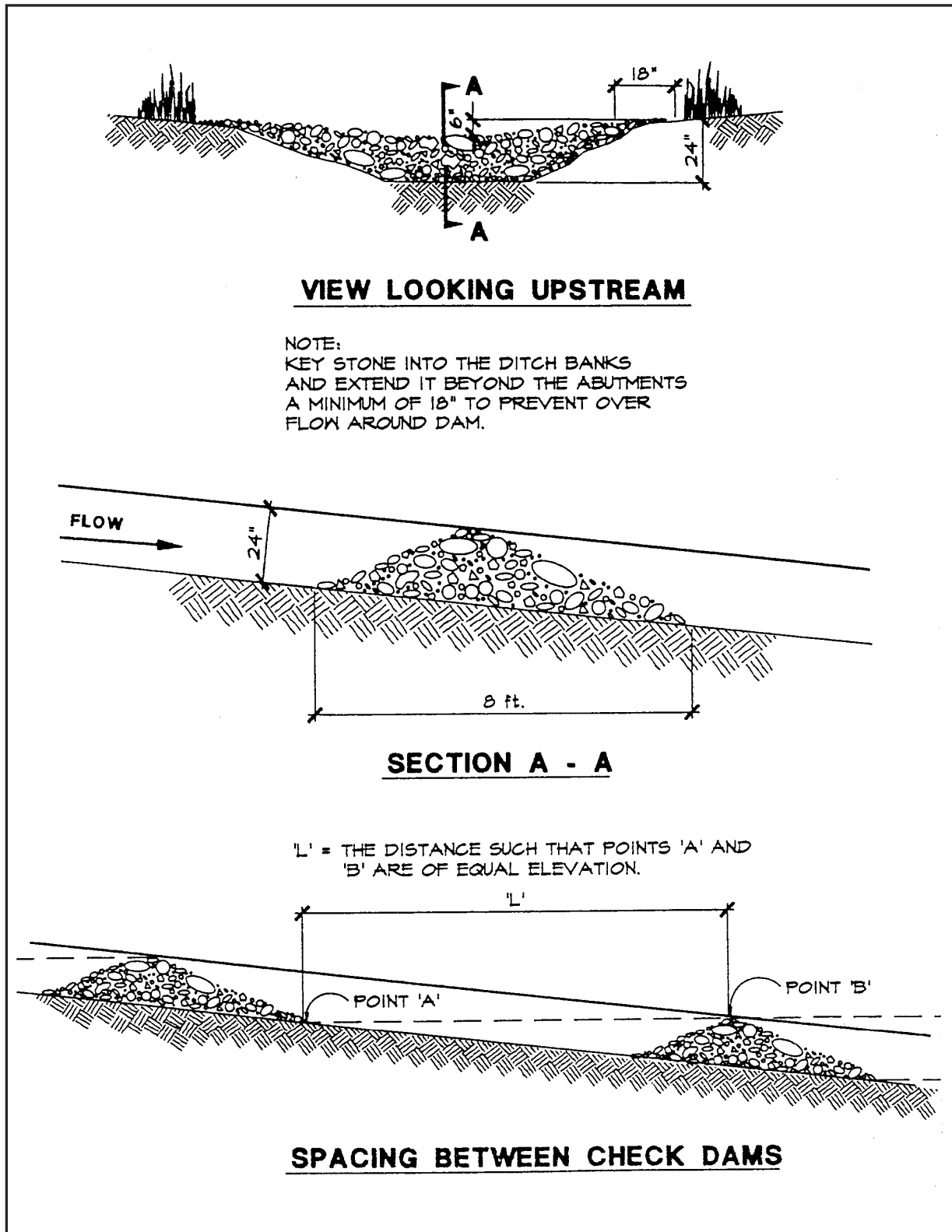

Figure 4.8a. Rock Check Dam

Source: Erosion Draw

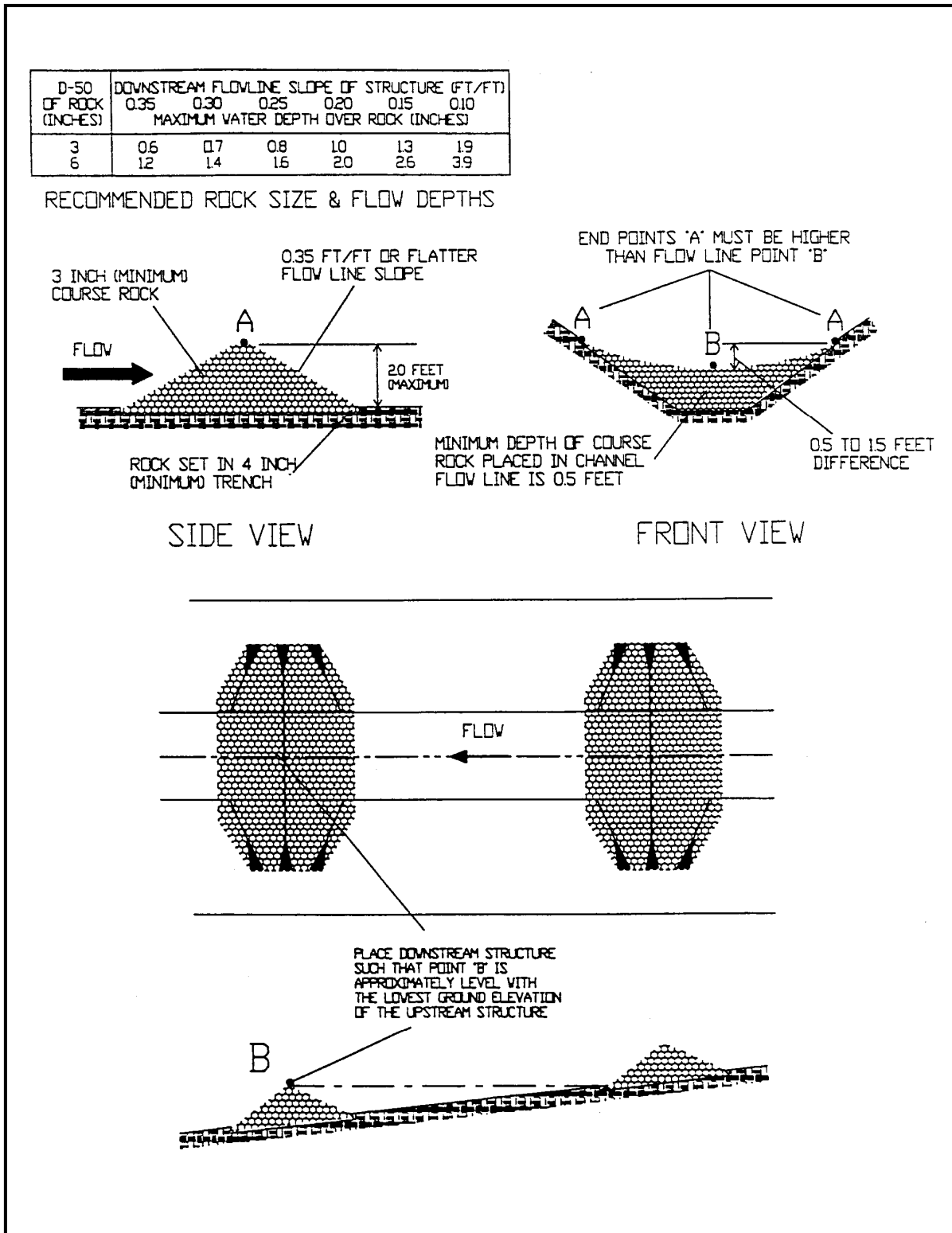

Figure 4.8b. Rock Check Dam Details

Source: HydroDynamics, Inc.

Maintenance

Check dams should be checked for sediment accumulation after each significant rainfall. Sediment should be removed when it reaches one-half of the original height or before. Regular inspections should be made to ensure that the center of the dam is lower than the edges. Erosion caused by high flows around the edges of the dam should be corrected immediately.

Removal

Check dams must be removed when their useful life has been completed. In temporary ditches and swales, check dams should be removed and the ditch filled in when it is no longer needed. In permanent structures, check dams should be removed when a permanent lining can be installed. In grass-lined ditches, check dams should be removed when the grass has matured sufficiently to protect the ditch or swale. The area beneath the check dams should be seeded and mulched or sodded (depending on velocity) immediately after the dams are removed.

If stone check dams are used in grass-lined channels that will be mowed, care should be taken to remove all the stone from the dam when the dam is removed. This should include any stone that has washed downstream.

Tab
Insert

CHAPTER 5: BEST MANAGEMENT PRACTICES FOR DEWATERING OPERATIONS

- 5.1 Introduction
- 5.2 Limitations
- 5.3 Implementation
- 5.4 Inspection and Maintenance
- 5.5 Control Technologies
 - 5.5.1 *Sediment Traps and Sediment Basins*
 - 5.5.2 *Weir Tanks and Dewatering Tanks*
 - 5.5.3 *Filters*
 - 5.5.4 *Chemical Treatment*

* * * * *

5.1 Introduction

A number of technologies are available to engineers, hydrologists, and construction personnel for removing suspended sediment and reducing the associated turbidity in waters produced as a part of dewatering operations at construction sites in Florida. Dewatering operations are practices that manage the discharge of pollutants when waters other than stormwater (nonstormwater) and accumulated precipitation must be removed from a work location so that construction may be carried out. Nonstormwater includes, but is not limited to, ground water, water from cofferdams, water diversions, and water used during construction activities that must be removed from a work area.

Dewatering operations provide unique challenges at construction sites. This is primarily because of the possibility of adverse impacts to receiving waterbodies and often because of the limited land area available for implementing control practices. The waters associated with dewatering operations are also highly variable in their quality and are associated with highly varying geological materials and other environmental influences. In addition, construction sites in Florida are often subject to high water table conditions, and various dewatering activities and associated practices must be used to locally lower ground water levels, in order to facilitate excavation and construction activities and manage stormwater and other waters onsite.

A variety of methods can be used to treat water during dewatering operations. The methods described in this chapter are used to manage discharges of nonstormwater from construction sites.

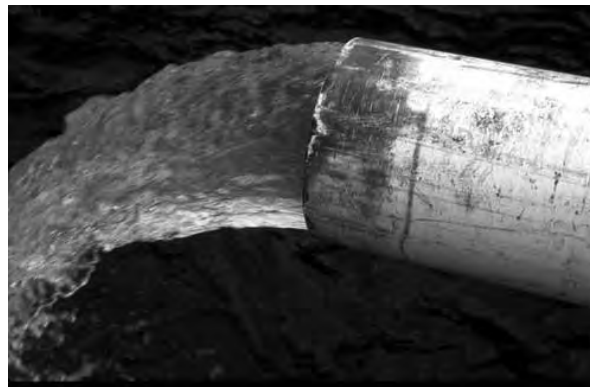

They are also appropriate for managing the removal of accumulated precipitation (stormwater) from depressed areas at a construction site.

Four principal types of control technologies for dewatering are discussed: sediment traps and sediment basins, weir tanks and dewatering tanks, filters, and chemical treatment (see **Table 5.1** for a comparison of these technologies).⁶ These technologies and approaches provide options to achieve sediment removal. The size of particles present in the sediment and receiving water limitations for sediment are key considerations for selecting sediment treatment option(s); in some cases, the use of multiple devices in a “treatment train” may be appropriate.

The information provided for each group of technologies used in dewatering operations generally includes the following:

- *Description of the technology.*
- *General application of the technology.*
- *Limitations of the technology.*
- *Considerations for implementation of the technology.*
- *Inspection and maintenance needs.*
- *Design considerations for the technology.*

Table 5.1. Comparison of Dewatering Technologies

Treatment Technology Group	Treatment Technology	Pollutant Treated	Design Flow (gallons per minute [gpm])	Footprint (square feet)
Sediment Traps and Sediment Basins	Sediment Traps	Sediment	25 to 500	Varies
	Sediment Basins	Sediment	25 to 500	Varies
Weir Tanks and Dewatering Tanks	Weir Tanks	Sediment, Metals, Oil, and Grease	60 to 100	1,800
	Dewatering Tanks	Sediment, Metals, Oil, and Grease	Varies	1,200 to 1,500
Filters	Gravity Bag Filter	Sediment and Metals	300 to 800	100 to 400
	Sand Media Filter	Sediment, Metals, Biochemical Oxygen Demand (BOD)	80 to 1,000	17 to 450
	Pressurized Bag and Cartridge Filter	Sediment, Metals, BOD, and Hydrocarbons	50 to 1,000	200 to 320
Chemical Treatment	Continuous Chemical Treatment	Sediment	Varies	Varies
	Batch Chemical Treatment	Sediment	Varies	Varies

⁶ Additional design specifications and implementation guidance for many of the technologies discussed in this chapter are provided in other chapters (see the Contents). Source: Caltrans, 2006.

5.2 Limitations

The following general limitations apply to dewatering operations:

- *Site conditions dictate the design and use of dewatering operations.*
- *The controls discussed in this chapter address sediment only.*
- *The controls described in this chapter allow only minimal settling time for sediment particles. Use these controls only when site conditions restrict the use of the other control methods.*
- *Dewatering operations require, and must comply with, applicable local and FDEP and water management district regulatory requirements. For discharges of produced ground water from a non-contaminated site activity, an FDEP Generic Permit for the Discharge of Produced Ground Water from any Non-Contaminated Activity (Generic Permit) is required (additional information is available at [http://www.dep.state.fl.us/legal/rules/shared/62-621\(2\).doc](http://www.dep.state.fl.us/legal/rules/shared/62-621(2).doc)). For contaminated sites, no Generic Permit is available, and FDEP should be contacted for applicable requirements (a listing of rules by number is available at <http://www.dep.state.fl.us/legal/rules/rulelistnum.htm>). For water management district regulatory requirements, contact the district with jurisdiction where the construction site is located.*
- *Avoid dewatering discharges, if possible, by using the water for dust control, infiltration, etc.*
- *The design of dewatering operations requires significant professional judgment and experience because of the many influencing environmental variables to consider, including pumping rate, depth and area of dewatering, depth to ground water table, soil hydraulic conductivity, and soil particle sizes.*

5.3 Implementation

The following issues are important in the implementation of dewatering activities:

- *Dewatering nonstormwater cannot be discharged without prior notice to and approval from FDEP and the local water management district. This includes stormwater that is comingled with ground water or other nonstormwater sources. Once the discharge is allowed, appropriate BMPs must be implemented to ensure that the discharge complies with all permitting and other regulatory requirements.*
- *FDEP may require a separate NPDES permit prior to the dewatering discharge of nonstormwater. These permits have specific testing, monitoring, and discharge requirements and can take a significant amount of time to obtain.*
- *The flow chart in **Figure 5.4** should be used to guide dewatering operations.*
- *Dewatering discharges must not cause erosion at the discharge point.*

5.4 Inspection and Maintenance

A number of essential inspection and maintenance activities should be carried out as part of dewatering operations. These include the following:

- *Inspect and verify that BMPs are in place before beginning dewatering activities.*
- *While activities associated with the BMP are under way, inspect during the rainy season and at least weekly in the nonrainy season to verify continued BMP implementation.*
- *Inspect BMPs subject to nonstormwater discharges until dewatering operations are completed.*
- *Follow the specific maintenance requirements provided in the description of each BMP.*
- *Sediment removed during the maintenance of a dewatering device may be either spread onsite and stabilized, or disposed of at a disposal site as approved by the owner.*
- *Sediment that is comingled with other pollutants must be disposed of in accordance with all applicable laws and regulations and as approved by the owner.*

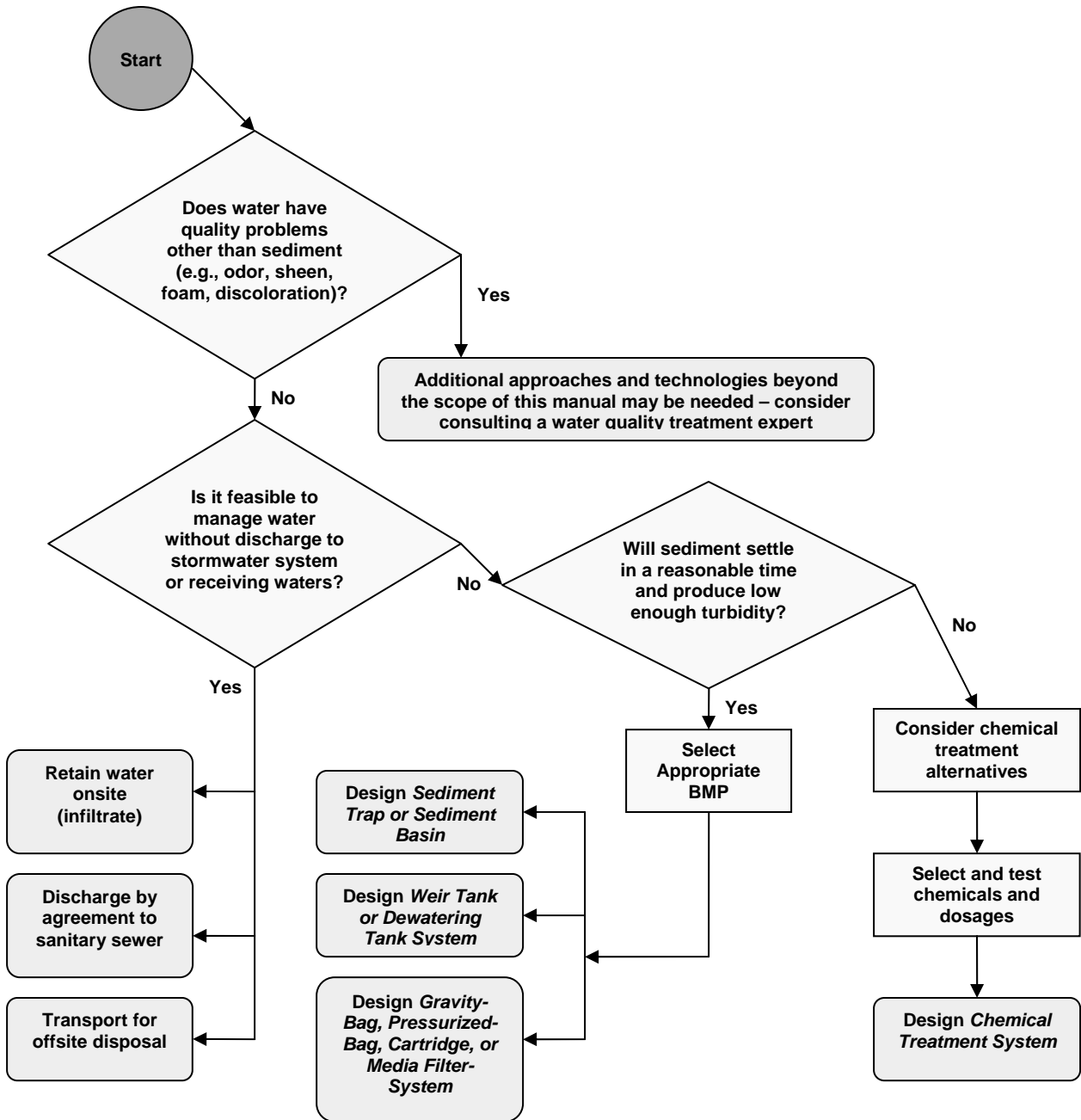
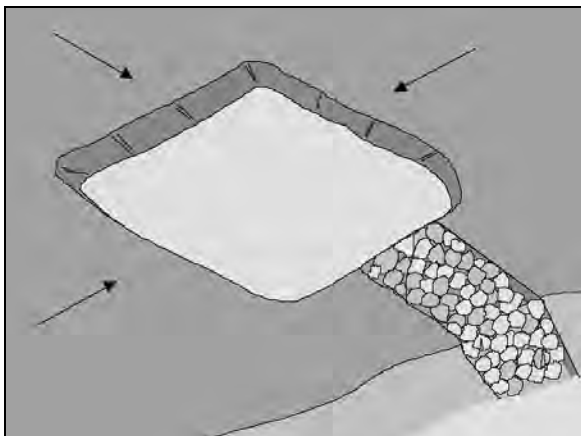

Figure 5.4. Dewatering Operations Flow Chart

5.5 Control Technologies

5.5.1 Sediment Traps and Sediment Basins

Sediment Trap



Sediment Trap



Sediment Trap

(Source: <http://www.mnerosion.org>)

— **A sediment trap is a temporary basin formed by the excavation and/or construction of an earthen embankment or low drainage area to detain sediment-laden runoff and allow sediment to settle out before discharging. Sediment traps are generally smaller than sediment basins.** —

WHAT IS ITS PURPOSE?

- *Effective for the removal of large and medium-size particles (sand and gravel) and some metals that settle out with the sediment.*

WHERE AND HOW IS IT COMMONLY USED?

- *The inflow pipe should be located as far away from the outfall as possible to increase the residence time in the trap and allow more time for sediments to settle out.*
- *Use rock or vegetation to protect the trap outlets against erosion.*

WHAT MAINTENANCE ACTIVITIES CAN BE EXPECTED?

- *Daily inspections of sediment trap embankments and the discharge point should be performed to prevent washout, scouring, and embankment blowouts.*
- *Sediment must be removed when the storage volume is reduced by one-half.*

Sediment Basin

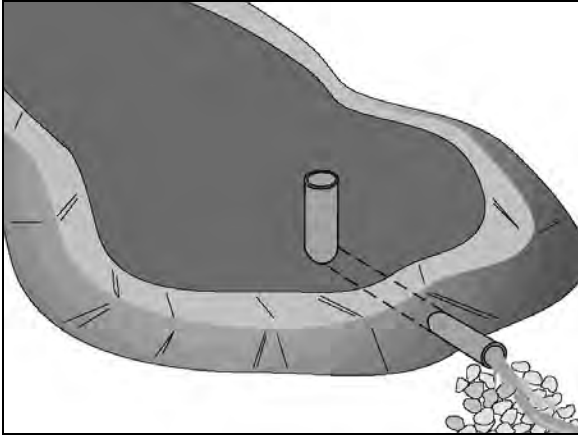

Sediment Basin



Sediment Basin

(Source: <http://www.dot.ca.gov>)

— A sediment basin is a temporary basin with a controlled-release structure that is formed by the excavation or construction of an embankment to detain sediment-laden runoff and allow sediment to settle out before discharging. Sediment basins are generally larger than sediment traps. —

WHAT IS ITS PURPOSE?

- Effective for the settling of sediments such as sand, silt, and some metals that settle out with the sediment.

WHERE AND HOW IS IT COMMONLY USED?

- Excavation and construction of related facilities is required.
- Temporary sediment basins must be fenced if safety is a concern.
- Outlet protection is required to prevent erosion at the outfall location.
- If offsite discharge is proposed, the turbidity sampling location should be at the discharge point of the basin.

WHAT MAINTENANCE ACTIVITIES CAN BE EXPECTED?

- Daily inspections of sediment basin embankments and the discharge point should be performed to prevent washout, scouring, and embankment blowouts.
- Sediment must be removed when the storage volume is reduced by one-half.

5.5.2 Weir Tanks and Dewatering Tanks

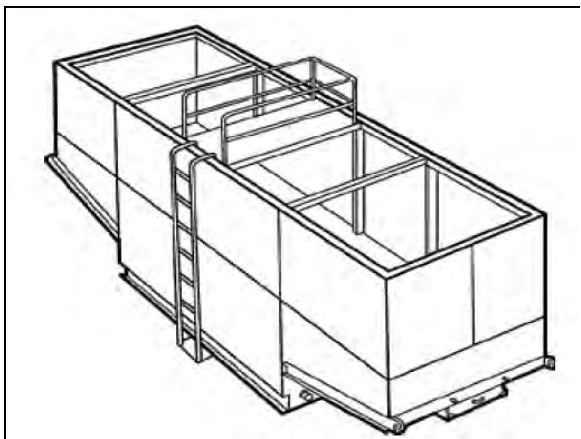

Weir Tank (Baker Tank)
(Source: <http://www.dot.ca.gov>)



Dewatering Tank
(Source: <http://www.dot.ca.gov>)

Weir Tank

— A weir tank separates water and waste by using weirs. The configuration of the weirs (over and under weirs) maximizes the residence time in the tank and determines the waste to be removed from the water, such as oil, grease, and sediments. —

WHAT IS ITS PURPOSE?

- The tank removes trash, some settleable solids (gravel, sand, and silt), some visible oil and grease, and some metals (removed with sediment). To achieve high levels of flow, multiple tanks can be used in parallel. If additional treatment is desired, the tanks can be placed in a series or used as pretreatment for other methods.

WHERE AND HOW IS IT COMMONLY USED?

- The tank is delivered to the site by the vendor, who can provide assistance with setup and operation.
- The tank size depends on flow volume, constituents of concern, and required residence time. Vendors should be consulted to appropriately size the tank.

WHAT MAINTENANCE ACTIVITIES CAN BE EXPECTED?

- Periodic cleaning is required based on visual inspection or reduced flow.
- Oil and grease disposal must be carried out by a licensed waste disposal company.

Dewatering Tank

— *A dewatering tank removes debris and sediment. Flow enters the tank through the top, passes through a fabric filter, and is discharged through the bottom of the tank. The filter separates the solids from the liquids. —*

WHAT IS ITS PURPOSE?

- *The tank removes trash, gravel, sand, silt, some visible oil and grease, and some metals (removed with sediment). To achieve high levels of flow, multiple tanks can be used in parallel. If additional treatment is desired, the tanks can be placed in a series or used as pretreatment for other methods.*

WHERE AND HOW IS IT COMMONLY USED?

- *The tank is delivered to the site by the vendor, who can provide assistance with setup and operation.*
- *The tank size depends on flow volume, constituents of concern, and required residence time. Vendors should be consulted to appropriately size the tank.*

WHAT MAINTENANCE ACTIVITIES CAN BE EXPECTED?

- *Periodic cleaning is required based on visual inspection or reduced flow.*
- *Oil and grease disposal must be carried out by a licensed waste disposal company.*

5.5.3 Filters

Gravity Bag Filter

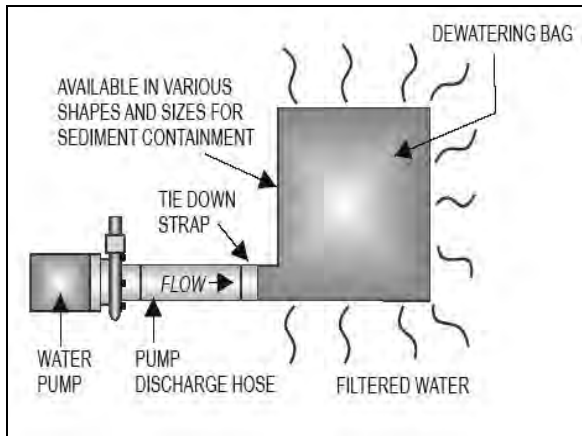

Gravity Bag Filter



Gravity Bag Filter

(Source: <http://www.spillcontainment.com>)

— **A gravity bag filter, also referred to as a dewatering bag, is a square or rectangular bag made of nonwoven geotextile fabric that collects sand, silt, and fines.** —

WHAT IS ITS PURPOSE?

- *Effective for the removal of sediments (gravel, sand, and silt). Some metals are removed with the sediment.*

WHERE AND HOW IS IT COMMONLY USED?

- *Water is pumped into one side of the bag and seeps through the bottom and sides of the bag.*
- *A secondary barrier, such as a rock filter bed or geobarrier, is placed beneath and beyond the edges of the bag to capture sediments that escape the bag.*

WHERE AND WHEN SHOULD IT NOT BE USED?

- *Based on the velocity of water passing through the bag, the seams of the bag may fail.*

WHAT MAINTENANCE ACTIVITIES CAN BE EXPECTED?

- *The flow conditions, bag condition, bag capacity, and secondary barrier must be inspected.*
- *The bag should be replaced when it no longer filters sediment or passes water at a reasonable rate.*
- *The bag is disposed of offsite.*

Sand Media Filter



Sand Media Particulate Filter
(Source: <http://www.dot.ca.gov>)



Sand Media Particulate Filter
(Source: <http://www.spillcontainment.com>)

— *Water is treated by passing it through canisters filled with sand media. Generally, sand filters provide a final level of treatment. They are often used as a secondary or higher level of treatment after a significant amount of sediment and other pollutants has been removed using other methods.* —

WHAT IS ITS PURPOSE?

- *Effective for the removal of trash, gravel, sand, silt, and some metals, as well as the reduction of BOD and turbidity.*
- *Sand filters can be used for stand-alone treatment or in conjunction with bag and cartridge filtration if further treatment is required.*
- *Sand filters can also be used to provide additional treatment of water treated by settling or basic filtration.*

WHERE AND HOW IS IT COMMONLY USED?

- *The filters require delivery to the site and initial setup. The vendor can provide assistance with installation and operation.*

WHAT MAINTENANCE ACTIVITIES CAN BE EXPECTED?

- *The filters require regular service in order to monitor and maintain the level of the sand media. If subjected to high loading rates, filters can plug quickly.*
- *Vendors generally provide data on maximum head loss through the filter. The filter should be monitored daily while in use and cleaned when head loss reaches target levels.*
- *If cleaned by backwashing, the backwash water may need to be hauled away for disposal, or returned to the upper end of the treatment train for another pass through the series of dewatering BMPs.*

Pressurized Bag and Cartridge Filters



Pressurized Bag Filter
(Source: <http://www.dot.ca.gov>)



Cartridge Filter
(Source: <http://www.dot.ca.gov>)

— A pressurized bag filter is a unit composed of single-filter bags made from polyester felt material. The water filters through the unit and is discharged through a header. Vendors provide bag filters in a variety of configurations. Some units include a combination of bag filters and cartridge filters for enhanced contaminant removal. —

— Cartridge filters provide a high degree of pollutant removal when a number of individual cartridges are used as part of a larger filtering unit. They are often used as a secondary or higher (polishing) level of treatment after a significant amount of sediment and other pollutants is removed. Units come with various cartridge configurations (for use in a series with bag filters) or with a larger single-cartridge filtration unit (with multiple filters within). —

WHAT IS ITS PURPOSE?

- Effective for the removal of sediment (sand, silt, and some clays) and some metals, as well as the reduction of BOD, turbidity, and hydrocarbons. Oil-absorbent bags are available for hydrocarbon removal.
- Filters can be used to provide secondary treatment for water treated through settling or basic filtration.
- Hydrocarbons can often be removed with special resin cartridges.

WHERE AND HOW IS IT COMMONLY USED?

- The filters require delivery to the site and initial setup. The vendor can provide assistance with installation and operation.

WHAT MAINTENANCE ACTIVITIES CAN BE EXPECTED?

- The filter bags must be replaced when the pressure differential equals or exceeds the manufacturer's recommendation.
- The cartridges must be replaced when the pressure differential equals or exceeds the manufacturer's recommendation.

5.5.4 Chemical Treatment

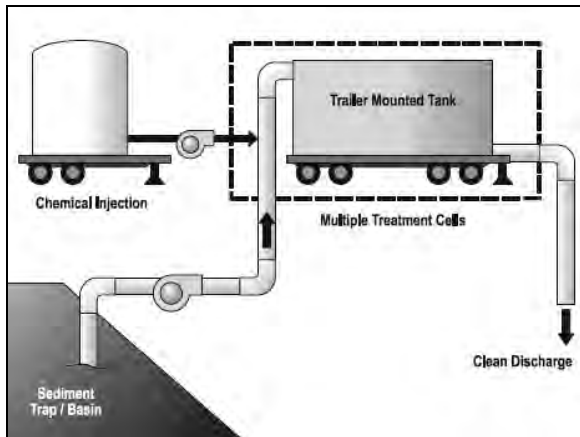

— Chemical treatment includes the application of carefully selected chemicals such as polymers (e.g., polyacrylamide [PAM]), alum, and other flocculants to waters to aid in the reduction of turbidity by more efficient removal of fine suspended sediment. —

WHAT IS ITS PURPOSE?

- Appropriate chemical treatment can reliably provide exceptional reductions of turbidity and associated pollutants and should be considered where turbid discharges to sensitive waters cannot be avoided using other available BMPs.

WHERE AND WHEN SHOULD IT NOT BE USED?

- FDEP must preapprove the use of chemical treatment.
- Petroleum-based polymers should not be used.
- Sediment basins or trailer-mounted units can be designed for chemical application.
- Treatment systems can be designed as flow-through continuous or batch-treatment systems.
- Chemical treatment systems may require a large area.
- Discharge rates may be limited, depending on the receiving waterbody.
- The design needs to consider operation and maintenance requirements.
- Treatment systems require monitoring for non-visible pollutants.

WHERE AND HOW IS IT COMMONLY USED?

- Turbidity is difficult to control if fine particles are suspended in dewatering discharges from a construction site. Sedimentation ponds are effective at removing larger particulate matter by gravity settling but are ineffective at removing smaller particulates such as clay and fine silt. Sediment ponds are typically designed to remove sediment no smaller than medium silt (0.02 mm). Chemical treatment may be used to reduce the turbidity of waters to be

discharged. Turbidities need to be reduced to levels less than 29 nephelometric turbidity units (NTUs) above background.

- *Chemically treated waters to be discharged from construction sites must be nontoxic to aquatic organisms. The protocol described below should be used to evaluate chemicals proposed for use in treatment at construction sites. The authorization to use a chemical in the field based on this protocol does not relieve the applicant from responsibility for meeting all discharge and receiving water criteria applicable to a site. The protocol is as follows:*
 - Treatment chemicals must be approved by FDEP and EPA for potable water use.
 - Prior to authorization for field use, laboratory batch tests should be conducted to demonstrate that the turbidity reduction necessary to meet the receiving water criteria could be achieved. Test conditions, including but not limited to raw water quality and laboratory test procedures, should be indicative of field conditions. Although these small-scale tests cannot be expected to reproduce performance under field conditions, they are indicative of treatment capability. Testing should use water from the construction site where the treatment chemical is proposed for use.
 - Prior to authorization for field use, the chemical treatment should be tested for aquatic toxicity using a “worst-case scenario” of whole-product release. Whole Effluent Toxicity (WET) testing and limits (ASTM International WET test procedures), should be used.
 - The proposed maximum dosage should be at least a factor of five lower than the no observed effects concentration (NOEC).
 - The approval of a proposed treatment chemical should be conditional, subject to full-scale bioassay monitoring of treated waters at the construction site where the proposed treatment chemical is to be used.
 - Treatment chemicals that have already passed the above testing protocol do not need to be re-evaluated. Contact FDEP for a list of treatment chemicals that may be approved for use.

HOW SHOULD IT BE DESIGNED?

- *The design and operation of a chemical treatment system should take into consideration the factors that determine optimum, cost-effective performance. It may not be possible to fully incorporate all of the classic concepts into the design because of practical limitations at construction sites. Nonetheless, it is important to recognize the following:*
 - The **right** chemical must be used at the **right** dosage. A dosage that is either too low or too high is not likely to produce the lowest turbidity. There is usually an optimum dosage rate.
 - The coagulant must be mixed rapidly into the water to ensure proper dispersion.
 - Sufficient flocculation might occur in the pipe leading from the point of chemical addition to the settling or sediment basin.
 - Chemical treatment systems require the mixing of the chemical and turbid water for flocculation to occur. The size and volume of the treatment system may be restricted to provide adequate mixing.

- In designing the withdrawal system, care must be taken to minimize outflow velocities and to prevent floc discharge. If possible, the discharge should be directed through a physical filter such as a vegetated swale to catch any unintended floc discharge.
- A pH-adjusting chemical should be added into the sediment basin, if needed, to control pH.

CTS-1 Continuous Treatment

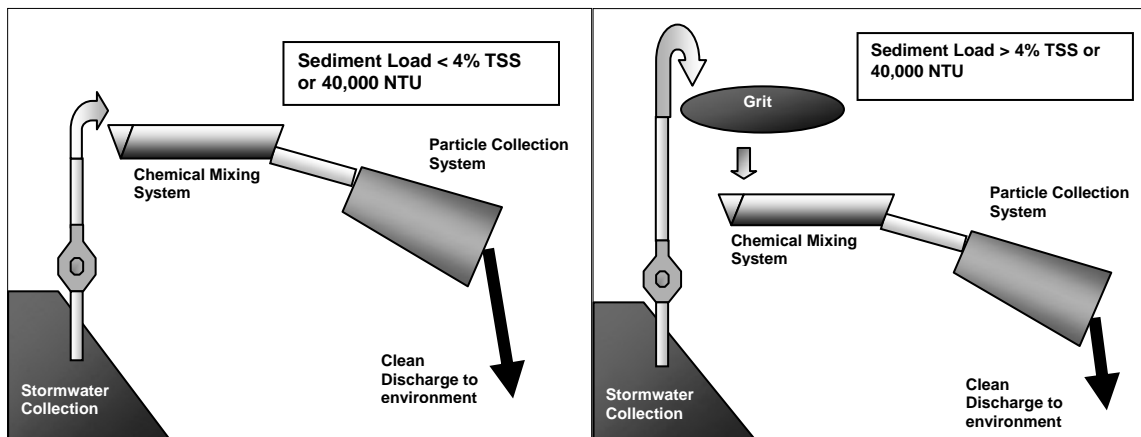

WHAT IS ITS PURPOSE?

- *Chemical treatment systems can be designed as flow-through continuous treatment systems.*
- *These systems consist of a collection system, a chemical mixing system (where the chemical is mixed with the turbid water), a sediment collection device, and interconnecting conveyances.*
- *They may include a pump or pumps, to help convey turbid water through the treatment system; however, these are not always required.*
- *Primary sediment basins or grit pits may be required if the water to be treated has a high percentage of suspended solids, to prevent sediment from burying the treatment system and reducing its efficiency.*

WHERE AND HOW IS IT COMMONLY USED?

- *The size of the continuous treatment system has to allow for continuous mixing for the length of time required to complete the continuous treatment system reaction at the flow rate expected through the system.*
- *The combination of any holding areas and treatment system capacity should be large enough to treat the volume of water anticipated.*
- *The total suspended solids (TSS) of the water running through the treatment system is not to exceed 4% suspended solids or a turbidity reading greater than 40,000 NTU.*
- *Primary settling should be encouraged in a sediment basin or sediment trap if the suspended solids load is above this level.*
- *On sites where the suspended solids load heading to the treatment system is below this level, sediment basins or sediment traps are not required for normal flow conditions, but some sort of particle collection device should be installed to prevent sediment deposition in the treatment system due to heavy rain events.*

- *The following discharge flow rate limits apply, absent any local requirements:*
 - If the discharge is direct or indirect to a stream, the discharge flow rate should not exceed 50% of the peak flow rate for all events between the 2-year and the 10-year, 24-hour event.
 - If the discharge occurring during a storm event is equal to or greater than the 10-year storm, the allowable discharge rate is the peak flow rate of the 10-year, 24-hour event.
 - Discharge to a stream should not increase the stream flow rate by more than 10%.
 - If the discharge is directly to a lake or major receiving water, there is no discharge flow limit.
 - If the discharge is to a municipal storm drainage system, the allowable discharge rate may be limited by the capacity of the public system. It may be necessary to clean the municipal storm drainage system prior to the start of the discharge to prevent scouring solids from the drainage system.

WHAT MAINTENANCE ACTIVITIES CAN BE EXPECTED?

- *Inspect the flow-through treatment system at least daily and after rain events of ½ inch or greater, taking care to ensure the chemical treatment products are in place, moist, and have not been buried by sediment.*
- *Inspect, repair, and clean out the sediment collection devices as needed to keep the system working at peak efficiency.*
- *Compliance monitoring:*
 - pH and turbidity of the treated water.
 - pH and turbidity of the receiving water.
- *Discharge compliance:*
 - Treated stormwater must be sampled and tested for compliance with pH and turbidity limits at least weekly and during rain events of ½ inch or greater. These limits may be established by water quality standards or a site-specific discharge permit.
 - Sampling and testing for other pollutants may also be necessary at some sites.
 - Turbidity must be within 29 NTU of background turbidity. Background is measured in the receiving water, upstream from the treatment process discharge point.
 - pH must be within the range of 6.5 to 8.5 standard units (SU) and not cause a change in the pH of the receiving water of more than 0.2 SU.
 - It is often possible to discharge treated water that has a lower turbidity than the receiving water and that matches the pH.
 - Treated water samples and measurements should be taken from the point of discharge.
 - Compliance with water quality standards is determined in the receiving water.

- *Sediment removal and disposal:*
 - Flocculated sediment should be removed from the sediment collection devices as necessary. Treated sediment can be disposed of in a landfill or can be used as a topsoil amendment elsewhere on the site to help prevent erosion and enhance vegetation establishment.
 - Flocculated sediment should never be used as structural fill material.

CTS-2 Batch Treatment

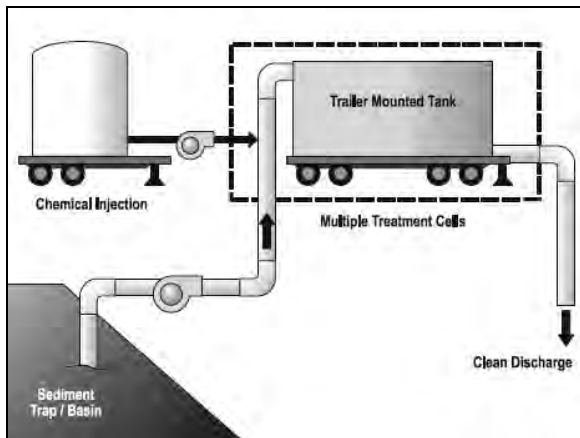

WHAT IS ITS PURPOSE?

- *Chemical treatment systems can be designed as batch treatment systems using either ponds or portable, trailer-mounted tanks.*
- *This chemical treatment system consists of a collection system, a sediment basin or sediment trap, pumps, a chemical feed system, treatment cells, and interconnecting piping.*

WHERE AND HOW IS IT COMMONLY USED?

- *The treatment system should use a minimum of two lined treatment cells. Multiple treatment cells allow for the clarification of treated water while other cells are being filled or emptied.*
- *Treatment cells may be basins, traps, or tanks. Portable tanks may also be suitable for some sites.*
- *The following equipment and supplies should be located in an operation shed:*
 - The chemical injector.
 - Secondary containment for substances such as acids, caustics, buffering compounds, diesel fuel, and treatment chemicals, in case a spill occurs.
 - Emergency shower and eyewash.
 - Monitoring equipment, consisting of a pH meter and a turbidimeter.
- *Sizing criteria:*
 - The combination of the sediment basin or other holding area and treatment capacity should be large enough to treat the volume of water anticipated.
 - Bypass should be provided around the chemical treatment system to accommodate extreme storm events.
 - Primary settling should be encouraged in the sediment basin/storage pond. A forebay with access for maintenance may be beneficial.
 - There are two opposing considerations in sizing the treatment cells. A larger cell is able to treat a larger volume of water each time a batch is processed.

However, the larger the cell the longer the time required to empty the cell. A larger cell may also be less effective at flocculation and may therefore require a longer settling time.

- The simplest approach to sizing the treatment cell is to multiply the allowable discharge flow rate by the desired drawdown time. A 4-hour drawdown time allows 1 batch per cell per 8-hour work period, given 1 hour of flocculation followed by 2 hours of settling.
- The permissible discharge rate governed by the potential downstream effect can be used to calculate the recommended size of the treatment cells.
- *The following discharge flow rate limits apply, absent any local requirements:*
 - If the discharge is direct or indirect to a stream, the discharge flow rate should not exceed 50% of the peak flow rate for all events between the 2-year and the 10-year, 24-hour event.
 - If discharge is occurring during a storm event equal to or greater than the 10-year storm, the allowable discharge rate is the peak flow rate of the 10-year, 24-hour event.
 - Discharge to a stream should not increase the stream flow rate by more than 10%.
 - If the discharge is directly to a lake or major receiving water, there is no discharge flow limit.
 - If the discharge is to a municipal storm drainage system, the allowable discharge rate may be limited by the capacity of the public system. It may be necessary to clean the municipal storm drainage system prior to the start of the discharge to prevent scouring solids from the drainage system.

WHAT MAINTENANCE ACTIVITIES CAN BE EXPECTED?

- *Chemical treatment systems must be operated and maintained by individuals with expertise in their use.*
- *These systems should be monitored continuously while in use.*
- *Test results should be recorded on a daily log kept onsite.*
- *Operational monitoring:*
 - pH, conductivity (as a surrogate for alkalinity), turbidity, and temperature of the untreated water.
 - Total volume treated and discharged.
 - Discharge time and flow rate.
 - Type and amount of chemical used for pH adjustment.
 - Amount of polymer, alum, or other flocculent used for treatment.
 - Settling time.
- *Compliance monitoring:*
 - pH and turbidity of the treated water.
 - pH and turbidity of the receiving water.

- *Biomonitoring:*
 - Treated water should be tested for acute (lethal) toxicity. Bioassays should be conducted by a laboratory approved by the state of Florida. **The performance standard for acute toxicity is no statistically significant difference in survival between the control and 100% chemically treated stormwater.** Acute toxicity tests should be conducted with the following species and protocols (or others approved by the state):
 - Fathead minnow, Pimephales promelas (96-hour static-renewal test, method: EPA/600/4-90/027F). Rainbow trout, Oncorhynchus mykiss (96-hour static-renewal test, method: EPA/600/4-90/027F), may be used as a substitute for fathead minnow.*
 - Daphnid, Ceriodaphnia dubia, Daphnia pulex, or Daphnia magna (48-hour static test, method: EPA/600/4-90/027F).*
 - All toxicity tests should meet quality assurance criteria and test conditions in the most recent versions of the EPA test method. Bioassays should be performed on the first 5 batches and on every 10th batch thereafter, or as otherwise approved by the state. Failure to meet the performance standard should be immediately reported to the state.*

- *Discharge compliance:*
 - **Prior to discharge, each batch of treated stormwater must be sampled and tested for compliance with pH and turbidity limits.** These limits may be established by water quality standards or a site-specific discharge permit. Sampling and testing for other pollutants may also be necessary at some sites. Turbidity must be within 29 NTUs of background turbidity. Background is measured in the receiving water, upstream from the treatment process discharge point. pH must be within the range of 6.5 to 8.5 SU and must not cause a change in the pH of the receiving water of more than 0.2 SU. It is often possible to discharge treated water that has a lower turbidity than the receiving water and that matches the pH. Treated water samples and measurements should be taken from the discharge pipe or another location representative of the nature of the treated water discharge. Samples used for determining compliance with water quality standards in the receiving water should not be taken from the treatment pond to decanting. Compliance with water quality standards is determined in the receiving water.

- *Operator training:*
 - Each contractor who intends to use chemical treatment should be trained by an experienced contractor on an active site for at least 40 hours.

- *Sediment removal and disposal:*
 - Sediment should be removed from the storage or treatment cells as necessary. Sediment remaining in the cells between batches may enhance the settling process and reduce the required chemical dosage.

Tab
Insert

CHAPTER 6: BEST MANAGEMENT PRACTICES FOR STORMWATER MANAGEMENT

- 6.1 Introduction
 - 6.1.1 *Nonstructural vs. Structural BMPs*
 - 6.1.2 *BMP Treatment Train*
 - 6.1.3 *Online vs. Offline BMPs*
- 6.2 Earthwork Specifications
- 6.3 Stormwater Retention Basin
- 6.4 Exfiltration Trench
- 6.5 Porous Pavement
- 6.6 Concrete Grid and Modular Pavement
- 6.7 Stormwater Detention Basin
- 6.8 Underdrain and Filtration Systems
- 6.9 Swales
- 6.10 Stormwater Conveyance Channel
- 6.11 Paved Flume
- 6.12 Diversion
- 6.13 Check Dam
- 6.14 Outlet Protection
- 6.15 Riprap
- 6.16 Grid Confinement System
- 6.17 Cellular Concrete Block
- 6.18 Maintenance
 - 6.18.1 *General*
 - 6.18.2 *Maintaining Retention Systems*
 - 6.18.3 *Maintaining Detention Systems*
 - 6.18.4 *Maintaining Conveyance Systems*
 - 6.18.5 *Maintaining Stormwater Management Structures*
 - 6.18.6 *Maintaining Vegetation*

* * * * *

6.1 Introduction

6.1.1 *Nonstructural vs. Structural BMPs*

The effective management of stormwater depends on the proper use of a number of specific BMPs. These are grouped into two broad categories: **nonstructural** and **structural**. Nonstructural controls are the first line of defense. They improve stormwater quality by reducing the generation and accumulation of potential stormwater pollutants at or near their sources. Therefore, they are frequently referred to as source controls. Nonstructural controls include practices such as planning and management, wetlands and floodplain protection, public education, proper fertilizer and pesticide

application control, solid waste collection and disposal, street cleaning, and "good housekeeping" techniques on construction sites. They are prevention oriented and very cost-effective.

In contrast, structural controls are used to control stormwater volume and peak discharge rate, and to reduce the magnitude of pollutants in discharge waters through physical containment or flow restrictions designed to allow settling, filtration, percolation, chemical treatment, or biological uptake. These practices typically are land intensive, require proper long-term maintenance, and can be costly, especially in already urbanized areas.

6.1.2 BMP Treatment Train

A stormwater management system could be considered a BMP treatment train, in which the individual BMPs are the cars. Generally, the more BMPs that are incorporated into the system, the better the performance of the treatment train. Although the different BMPs in this chapter are discussed individually, they often work together as part of a total system. Many BMPs are highly susceptible to clogging, especially those that use filtration. Treatment swales, sediment forebays, and stilling basins intercept sediments before they reach filtration BMPs, making sediment removal easier and less costly.

6.1.3 Online vs. Offline BMPs

Online BMPs temporarily store runoff before they discharge to surface waters. These systems capture all of the runoff from a design storm. They primarily provide flood control benefits, with water quality benefits secondary. However, some online BMPs, such as wet detention systems, can do an excellent job of achieving both objectives.

Offline BMPs divert the first flush of polluted stormwater (often called "treatment volume") and isolate it from the remaining stormwater, which is managed for flood control. Offline retention is the most effective water quality protection BMP, since the diverted first flush is not discharged to surface waters. It is removed by infiltration, evaporation, and evapotranspiration.

6.2 Earthwork Specifications

Definition

Specifications for earthworks maximize the use of the desirable physical properties of soil and take measures to compensate for weaknesses.

Purpose

To ensure that inadequate earthwork does not cause the premature failure of constructed improvements.



Conditions Where Practice Applies

This practice applies on all construction sites.

Construction Specifications

Subgrade Preparation

Proper subgrade preparation involves the clearing and grubbing of land. Except for muck soils, the subgrade should be free of organic debris, demolition debris, and large stones and rocks. If no fill is required, the ground should then be smoothed and compacted. If the area requires fill, the surface should be scarified or roughened to facilitate a bond between the original soil and the fill. Do not place fill on a smooth, compacted soil.

Filling, Backfilling, and Compaction

All fill material must be properly compacted. Large fill areas, such as embankments, dams, and building pads, can be mechanically compacted with heavy equipment in 6 to 8 inch (15 to 20 cm) lifts of compacted soil. Smaller above-ground fills, such as berms, can be compacted with heavy and medium equipment, or with hand tampers. Backfilling around pipes and manholes is the most sensitive operation, particularly around the bottom half of a pipe. Here fill should be placed in 2 to 4 inch (5 to 10 cm) lifts, and great care must be exercised to avoid damage to pipes, especially bituminous coated pipe. Small rollers or tampers are commonly used.

Fill can also be compacted using time and/or water. Where time is not a pressing factor, fill can simply be dumped in place and allowed to settle for several months. The primary force causing settlement is rain. The process can be shortened to several days by constant inundation with a sprinkler. Homebuilders commonly use this technique for compacting fill inside a stem-wall foundation; it can also be used to backfill under pipes. These techniques work best in very sandy soils. Regardless of the method used to achieve compaction, a compaction test should be performed before permanent structures are constructed on top of fill material.

6.3 Stormwater Retention Basin

Definition

A surface area used to store runoff for a selected design storm or specified treatment volume. Stormwater is retained onsite, with the storage volume recovered when the runoff percolates into the soil or evapotranspires.



Purposes

To reduce stormwater volume, peak discharge rate, and pollutants, and to recharge ground water and baseflow (see **Figure 6.3a**)

Conditions Where Practice Applies

The applicability of this practice primarily depends on the ability of soils to percolate runoff and on the availability of adequate land for a retention area or for modifications of an existing system (see **Figure 6.3b**). Geologic, topographic, and soil conditions must be considered in determining site suitability.

Besides soil infiltration rates, the single most significant limiting factor in many cases is the availability of enough land to provide the necessary storage volume. This is particularly true in densely urbanized areas, where land is scarce and property values are high.

The soil and water table conditions must also be such that the system can, in a maximum of 72 hours following a stormwater event, provide for a new volume of storage through percolation and/or evapotranspiration. When retention systems are vegetated as recommended, the runoff needs to percolate within 24 to 36 hours to ensure the viability of the vegetation. Retention systems do not release stored waters for surface discharge.

Construction Specifications

Initial basin excavation should be carried to within 1 foot (0.3 m) of the final elevation of the basin floor. Interior side slopes should be sodded immediately to prevent erosion and the introduction of additional sediments. Final excavation should be deferred until all contributing areas of the watershed are stabilized. Light equipment should be used to remove accumulated sediments and achieve final grade without compacting the basin floor. After final grading, the basin floor should be scarified with rotary tillers or disc harrows to promote infiltration and grass establishment.

Structural elements, such as embankments, inlets, flumes, and emergency spillways, shall be designed by a Florida registered professional engineer. These elements shall be constructed in accordance with **EARTHWORK SPECIFICATIONS** (in this chapter) and other acceptable engineering standards.

Do not allow sediment-laden runoff to enter a finished basin. Do not over-excavate to provide additional sediment capacity, unless the intent is to remove all sediments and backfill with a more pervious soil type.

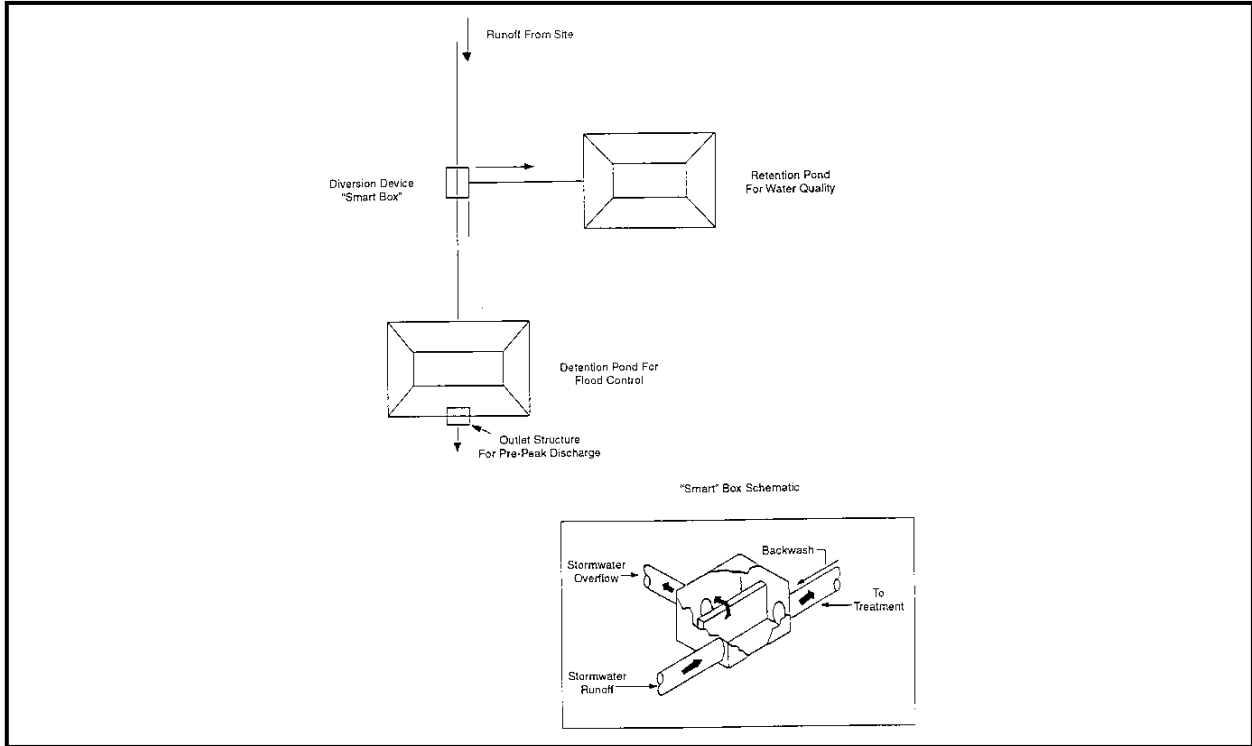

Figure 6.3a. Off-Line Treatment Systems

Source: NRCS

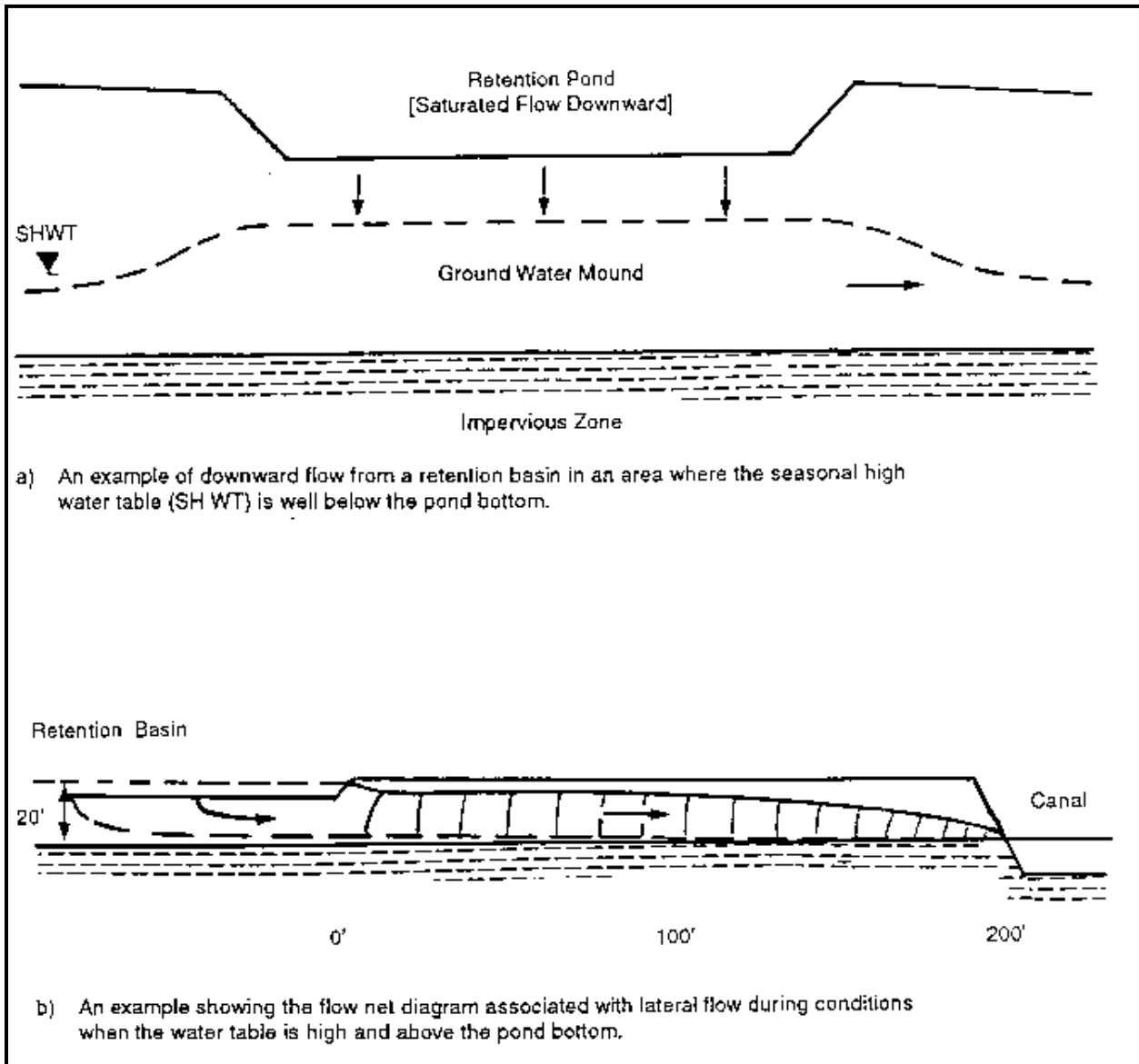

Figure 6.3b. Schematic of Flow Characteristics Associated with Infiltration from Retention Ponds during Low and High Water Table Conditions

Source: Hannon, 1980

6.4 Exfiltration Trench

(also referred to as infiltration pits and trenches)

Definition

This consists of the onsite retention of stormwater accomplished below the ground. The subsurface retention BMP most commonly used in Florida is an exfiltration trench, which is an excavated trench backfilled with coarse graded aggregate. Stormwater runoff is collected for temporary storage and infiltration. These facilities often include perforated pipe. Water is exfiltrated from the pipe and infiltrates the trench walls and, to some extent, the trench bottom for disposal and treatment. The addition of the pipe increases the amount of storage available in the system and promotes infiltration by making the delivery of the runoff waters more effective and evenly distributed over the length of the facility.



Exfiltration trenches should be designed as offline systems that include a weir overflow structure or a diversion sometimes called a "smart box." The device is installed at the point of inflow to the trench system. Its purpose is to route the runoff to be treated into the perforated pipe and trench for percolation into the surrounding soil. Excess water from larger storms is bypassed away from the trench (see **Figure 6.4a**).

Purposes

1. *To retain the "first flush" of stormwater runoff to promote water quality improvement.*
2. *To reduce the runoff volume and peak discharge rate from a site, thus helping to reduce downstream flooding and channel degradation.*
3. *To filter contaminants from runoff before they reach receiving waters and to promote the recharge of ground water supplies.*

Conditions Where Practice Applies

This practice should be used where the subsoil is sufficiently permeable to provide a reasonable rate of infiltration, and where the water table is sufficiently lower than the design depth of the facility. It is normally used where space is limited and land is expensive. Exfiltration trenches are frequently used to dispose of runoff from roof drains, parking lots, tennis courts, and roadways. They are not recommended where runoff water contains high concentrations of suspended materials, unless a presettling sediment trap or vegetated filter strip is provided to prevent premature clogging of the geotextile filter fabric (see **Figure 6.4b**). Likewise, grease and oil traps are also highly recommended prior to discharge to these systems. These precautions are primarily for maintenance reasons, since exfiltration systems are very susceptible to clogging and

sediment buildup, which reduce their hydraulic efficiency and storage capacity to unacceptable levels.

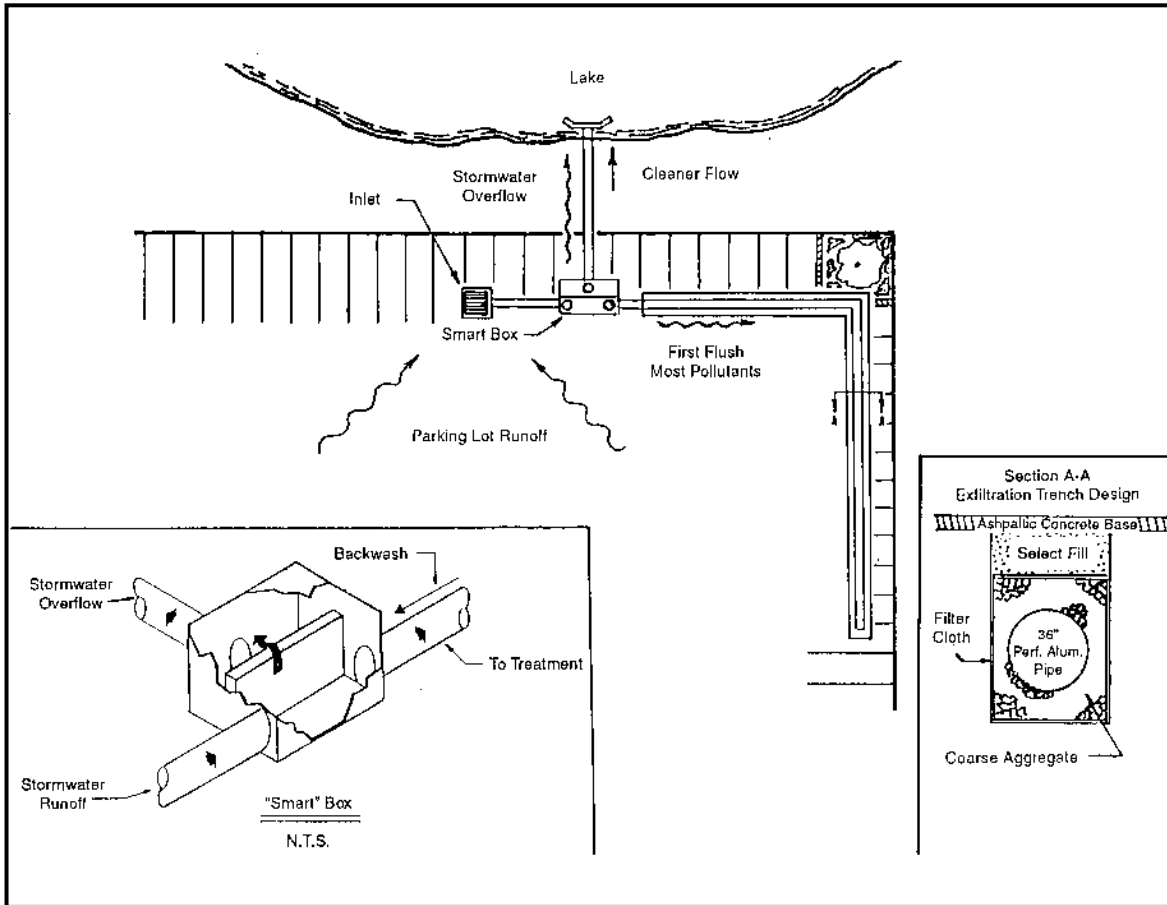

Figure 6.4a. Cross-Section of Typical Infiltration/Exfiltration System for Parking or Roads

Source: Dyer, Riddle, Mills and Precourt, Inc., Engineers/Surveyors

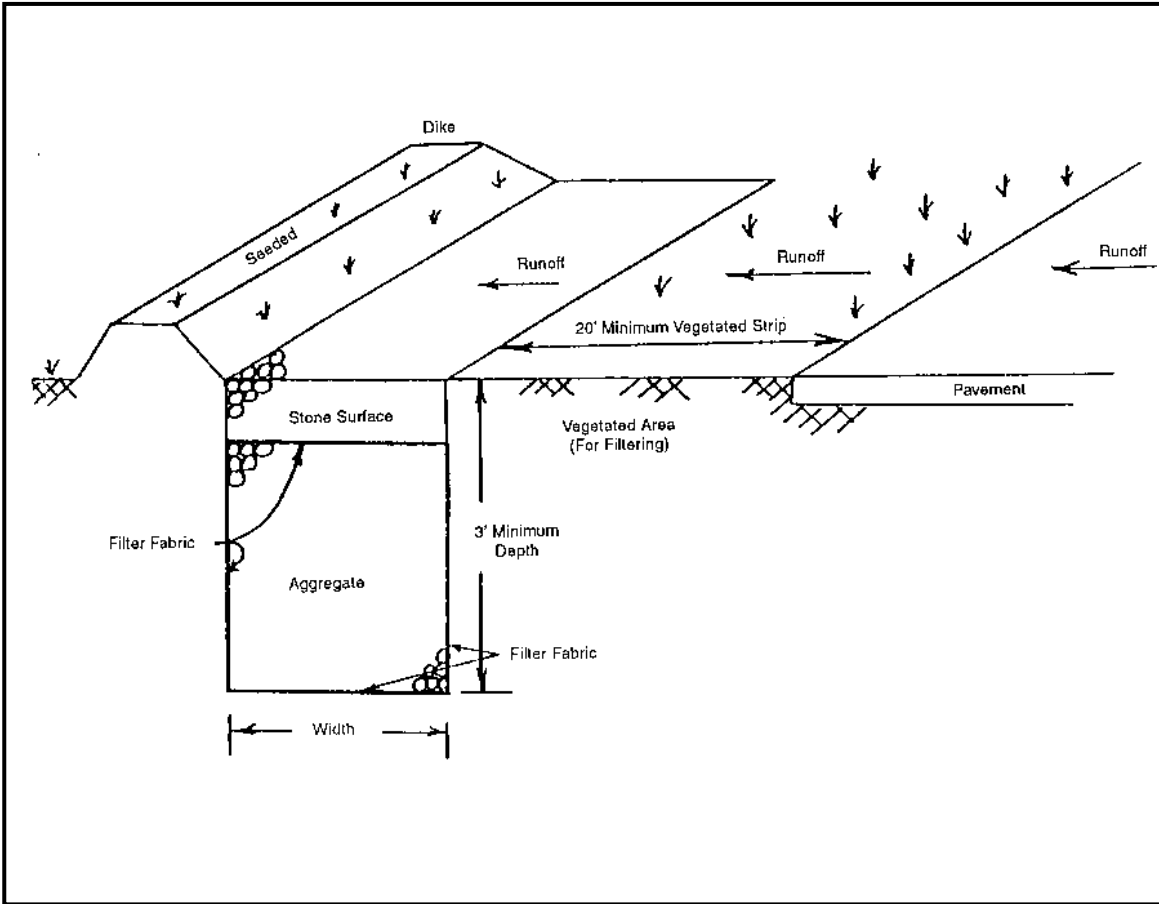

Figure 6.4b. Sample Application of a Vegetated Area for Pretreatment of Runoff Prior to Exfiltration in Frederick County, Maryland

Source: NRCS

Types of Infiltration Trenches

Trench construction criteria for three different soil and geologic conditions are as follows:

1. Trenches in Rock

Exfiltration facilities cut into permeable rock are often used in the Miami vicinity. These trenches are the least expensive infiltration system to construct; however, the following conditions must be met:

- 1. The rock must be able to support a specified wheel load on a covering concrete slab or other suitable cover.*
- 2. The rock must be amenable to excavation without blasting.*

The inlet to the system can be placed directly over the slab cover, with discharge directly into the trench. A more acceptable method is to set the inlet and catch basin adjacent to the trench and pipe the inflow to the trench. This technique lessens the introduction of debris into the system. Manhole access must be provided to facilitate cleaning and inspection.

2. Trenches in Stable Soil

In this type of trench, perforated or slotted pipe is normally used as the conduit. Coarse aggregate between the pipe and trench wall prevents sidewall collapse and distributes collected water to the trench walls. Whether the pipe is included or not, the trench is usually 4 to 5 feet (1.2 to 1.5 m) wide and deep enough to reach a permeable soil layer.

Coarse aggregate or other free-draining material is generally placed in the bottom of the trench and brought up to a specified pipe flowline grade, generally a minimum of 2 feet (60 cm). Perforated or slotted pipe is then placed in the trench, which is backfilled with coarse aggregate to the design storage elevation. A typical Dade County installation includes a 6 inch (15 cm) thickness of finer-textured filter material or pea rock placed over the aggregate backfill. The trench is normally covered with a geotextile to prevent the sand or fill used for cover from piping and possible surface subsidence.

These trench cross-sections are typical of most installations in extreme southern Florida. The configuration is applicable in other areas where the soil or substrate is stable and provides sufficient infiltration capacity. Even where infiltration rates are marginal, the system could supplement the drainage requirements of a positive outfall system by storing and infiltrating a portion of the stormwater into the soil, thus reducing the downstream requirements of the positive system.

3. Trenches in Cohesionless Soil or Sand

Although trenches in cohesionless soil require a different type of construction, the design, final shape, and size are the same as for a trench in stable soil. However, side slopes of 1.5:1 or 2:1 may be required, if the walls are not shored during construction. Filter cloth must be used along the periphery of the trench to prevent the migration of soil fines into the coarse aggregate backfill.

In a trench system where perforated pipe is used, a non-perforated section some 6 to 8 feet (1.8 to 2.4 m) in length is used to connect the trench to the catch basin or inlet. This procedure serves to prevent piping near structures and subsidence around the inlet. A concrete slab is generally placed around the catch basin or inlet.

In the design of a trench system, any one of the above types, or a combination, may be used. A positive overflow pipe or bypass is also recommended to allow for large storm events.

Construction Specifications

Safety

Trench construction techniques vary with local site conditions. Strict adherence to the Occupational Safety and Health Administration's (OSHA) Trench Safety Code, and/or other local regulations relative to acceptable construction practice, should be observed. Depending on the length and width of the trench, a backhoe, wheel, or ladder-type trencher may be used for excavation. Excavated material should be stored at least 10 feet (3 m) from the trench to avoid backsliding and cave-ins.

General Construction Recommendations

Proper construction and routine maintenance are extremely important for successful trench applications. A substantial number of trenches have failed shortly after being built, primarily due to poor construction practices or inadequate field testing, or because sediment was not filtered or trapped before entering the trench. The following construction and erosion control procedures should minimize the risk of premature clogging:

- 1. Before the entire development site is graded, the area planned for the trench should be roped off to prevent heavy equipment from compacting the underlying soils.*
- 2. Diversion berms should be placed around the perimeter of the trench during all phases of construction. Sediment and erosion control plans for the site should be oriented to keep sediment and runoff completely away from the trench area. Otherwise, the actual construction of the trench should not begin until after the site is completely stabilized.*
- 3. The trench should be excavated using a backhoe or trencher equipped with tracks or oversized tires. Normal rubber tires should be avoided, since they compact the subsoil and may reduce infiltration capability. For the same reason, the use of bulldozers or front-end loaders should be avoided.*
- 4. Sediment control is critical, and thus it is important that sediment and erosion controls be inspected following each storm to make sure they still work. If a vegetated buffer strip is planned for the pretreatment of runoff entering the facility, grass should be established immediately, preferably by sodding. When hydroseeding is used, reinforced silt fences must be placed between the buffer and trench to prevent sediment entry before the buffer becomes fully established.*

Perforated or Slotted Pipe

When perforated pipe is used for conveyance and distribution, a liberal number of holes should be provided to ensure free and rapid flow in and out of the walls of the pipe. Large-diameter pipe adds to total storage volume in the trench. The use of a pipe in the trench system also allows for ease of maintenance. The pipe serves as a catchment for sediment without reducing overall efficiency.

Pipes manufactured of plastic, steel, aluminum, concrete, or other materials are available for this application. Perforated metal pipes usually have 3/8 inch (9 mm) diameter perforations uniformly spaced around the full periphery of the pipe. Specifications stipulate not less than 30 perforations per square foot (323 perforations/m²) of pipe surface. Other perforations not less than 5/16 inch (8 mm) in diameter or slots are permitted if they provide a total opening area of not less than 3.31 square inches per square foot (230 cm²/m²) of pipe surface.

FDOT and industry have developed tentative specifications for slotted concrete pipe with cast slots, based on field performance and cooperative testing. Concrete pipe with 3/8 inch (9 mm) wide slots is usually specified. The slots should be circumferential in direction, approximately 3/8 inch (9 mm) wide and not less than 4 inches (10 cm) long at the inside of the pipe. Four rows of slots are generally specified for pipe 30 inches (75 cm) in diameter or less. Six rows are specified for pipe 36 inches (90 cm) in diameter and larger.

Pipe Backfill

Coarse aggregate backfill material supports the sides and top of an infiltration trench following construction. It also provides good bedding for distribution and overflow pipes. Aggregates for this purpose must be sound and must comply with FDOT-established specifications for durability. The material must provide sufficient void space to allow for the storage of the required volume of runoff. The designer should also allow for the accumulation of the normally encountered fine sands, silts, silty clays, and other material in stormwater that will pass through the perforations or slots in the pipe conduit into the backfill during the expected life of the facility.

Clean, washed stone aggregate should be placed in the excavated trench in lifts, **lightly** compacted to form the base. Unwashed stone has enough associated sediment to pose a clear risk of clogging at the soil/filter cloth interface. Granite, washed pea gravel, or river rock is usually acceptable. Where possible, the use of crushed limestone aggregate should be avoided unless the limestone is washed, contains little or no phosphorus, and is of the hard variety.

Pea Rock or Gravel

This material is often placed in a 6 inch (15 cm) layer over the top of the aggregate for the pipe backfill, as illustrated in **Figure 6.4c**. This layer serves as a granular filter below the filter fabric. The gradation for this layer should consist of 100% material passing the 1 inch (25 mm) sieve, with not more than 5% passing the No. 4 sieve.

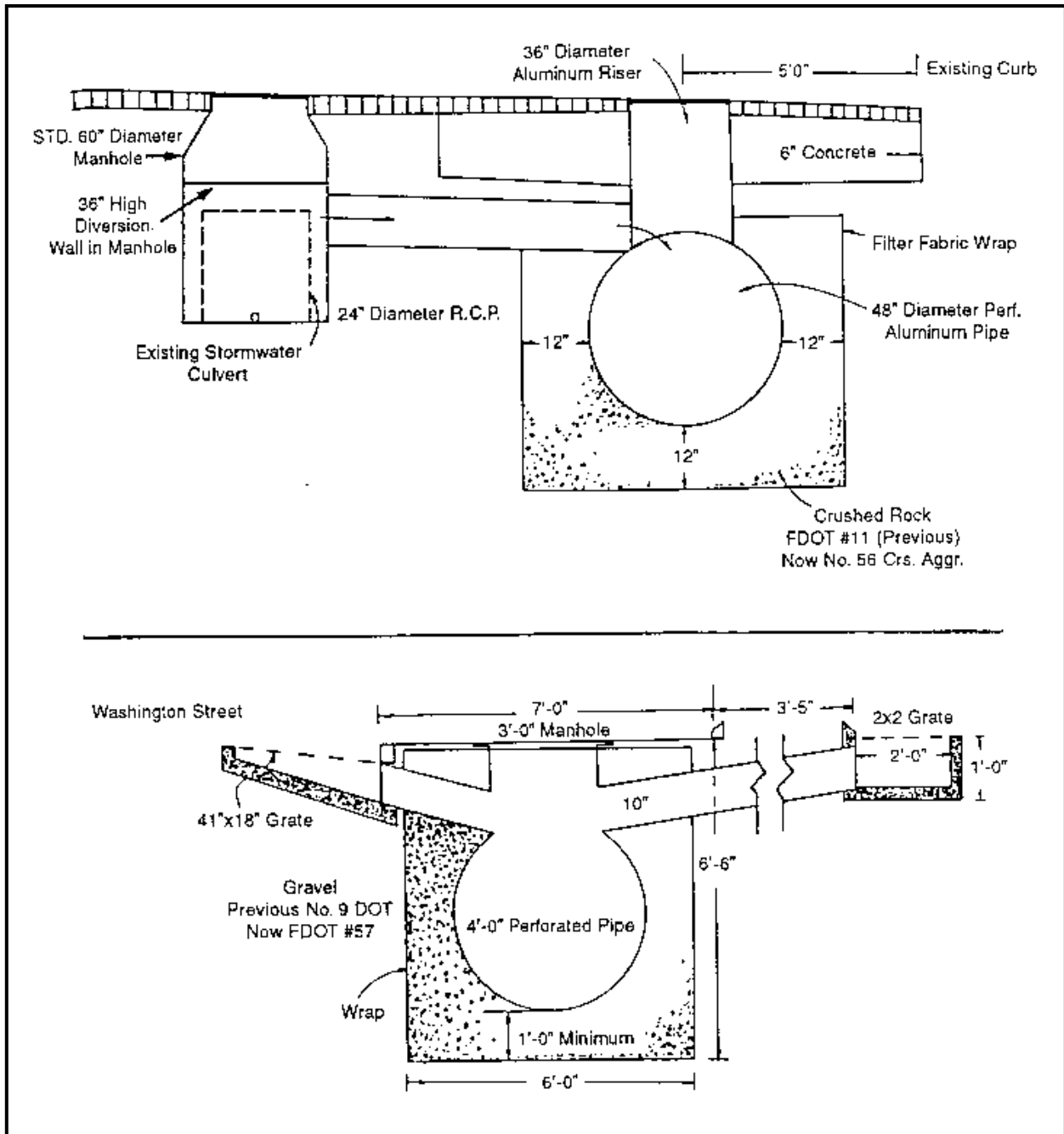

Figure 6.4c. Examples of Typical Underground Percolation Systems for Retrofitting Existing Storm Sewer Systems in Orlando, Florida

Source: NRCS

Synthetic Filter Fabrics

When fine native materials are encountered in the excavation, a filter cloth envelope or wrap should be placed around the coarse aggregate backfill. This practice prevents the migration of fine sediments from the surrounding soil that could clog the trench following reverse flow conditions resulting from high ground water. A number of plastic woven or nonwoven filter fabrics can be used for this purpose. However, care should be taken to prevent tearing or puncturing the fabric. Likewise, adjacent sheets should be overlapped 12 to 18 inches (30 to 45 cm) and secured to prevent openings from developing.

To ensure good performance, synthetic fabrics (either woven or nonwoven) must be carefully selected, based on the properties required. As with aggregate filters, fabric filters must provide two very important functions, as follows:

- 1. They must be able to prevent clogging of the drain by the migration of erodible soil or other material from the substrate into the trench, which could also result in erosion, piping, or other problems.*
- 2. They must not inhibit the free flow of water.*

Care should be taken in selecting the proper kind of filter fabric, as available brands differ significantly in their permeability and strength. If desired, a 6 inch (15 cm) deep filter of clean, washed sand may be substituted for filter fabric on the bottom of the trench.

Likewise, the use of filter fabric directly surrounding slotted, corrugated polyethylene pipe has recently become a popular derivation of the typical exfiltration trench design. In these facilities, the sedimentation and filtration of particulates larger than the silt/clay size range take place within the perforated pipe. Consequently, the pipe is more prone to clogging, and large reductions in capacity occur more often than usual. While this may seem unacceptable, manufacturers point out that the pipe may be cleaned relatively easily using high-pressure hoses, vacuum systems, etc. On the other hand, conventional designs usually require complete replacement when clogging eventually occurs.

Observation Well

The installation of an observation well is recommended in every infiltration trench. It serves the following two primary functions:

- 1. It indicates how quickly the trench dewateres following a storm.*
- 2. It provides a method of observing how quickly the trench fills up with sediments.*

A simple observation well may consist of perforated polyvinyl chloride (PVC) pipe 4 to 6 inches (10 to 15 cm) in diameter. It is usually located in the center of the facility and is constructed flush with the ground elevation of the trench, as shown in **Figure 6.4d**. The top of the well should be capped and locked to discourage vandalism and tampering.

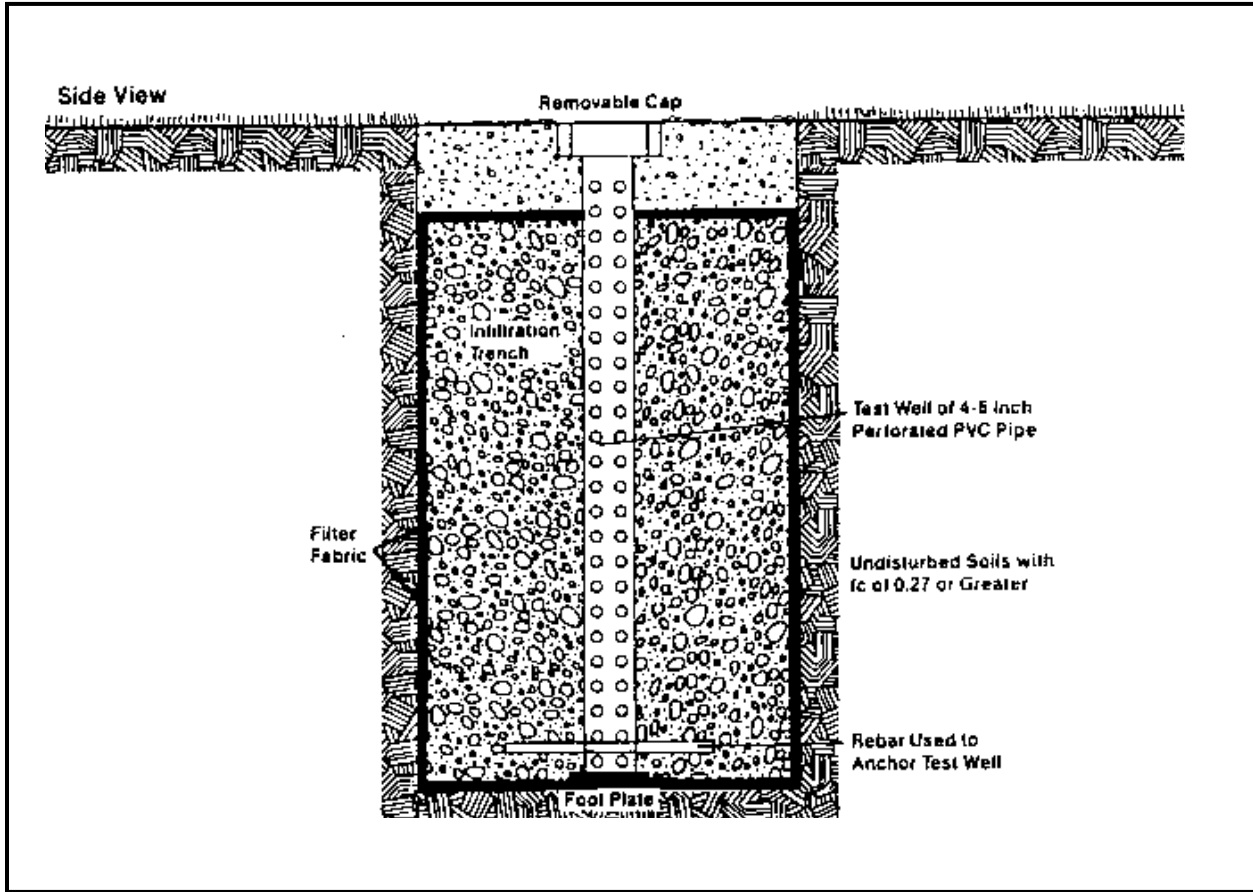

Figure 6.4d. Detailed Schematic of a Typical Observation Well

The observation well is needed to monitor the performance of the trench and is also useful in marking the trench location. The drain time for a trench can be measured by placing a graduated dipstick down the well immediately after a storm and again 24 and 48 hours later.

For the first year after the completion of construction, the well should be monitored quarterly and after every large storm. It is recommended that a logbook be maintained, indicating the rate at which the facility dewateres after large storms and the depth of the well at each observation. Once the performance characteristics of the structure have been verified, the monitoring schedule can be reduced to a semiannual basis, unless the performance data indicate that a more frequent schedule is required.

A monitoring well in the top foot (30 cm) of stone aggregate is required when the trench has a stone surface. Sediment buildup in the top foot (30 cm) of stone aggregate or the surface inlet should be monitored on the same schedule as the observation well. The sediment deposited shall not be allowed to build up to the point where it significantly reduces the rate of infiltration into the trench.

Overflow

Unless the facility is designed to accommodate the total amount of anticipated runoff from a large design storm, some provisions should be made for overflow. To provide the maximum benefit in reducing downstream flood peaks, these structures should be designed to overflow before the total storage capacity is reached. There are many ways to accomplish this. Pipes can be used, for instance, to connect a sequence of infiltration facilities, so that when the first one fills, it passes water through to the next one, and so on.

Generally, several smaller facilities are more effective than one large facility, though the latter may be necessary when there are space limitations. The capacity and cost of overflow discharge systems can be reduced by allowing temporary storage space above the infiltration trenches.

Because of the small drainage areas controlled by the exfiltration trench, an emergency spillway usually is not necessary. In all cases, however, the overland flow path of any surface runoff exceeding the capacity of the trench should be evaluated to preclude the development of an uncontrolled, erosive watercourse.

Seepage Analysis and Control

An analysis shall be made to determine any possible adverse effects of seepage zones when there are nearby building foundations, roads, parking lots, or sloping sites. Developments on sloping sites often require the use of extensive cut-and-fill operations. The use of infiltration trenches on fill sites with steep slopes is not recommended. Fill areas can be very susceptible to slope failure due to slippage along the interface of the undisturbed soil and the fill material. This condition could be further aggravated if the fill material is allowed to become saturated using retention practices. The methods for seepage analysis and the estimation of infiltration rates using Darcy's law and flow nets can be used to conduct the seepage analysis.

When exfiltration trenches are used in residential areas, special care must be taken to prevent seepage from causing unstable soil conditions near foundations. Trenches 3 or more feet (> 0.9 m) deep shall be located at least 10 feet (3 m) downgradient from foundation walls. Trenches should also be no closer than 100 feet (30 m) from wells or septic tanks.

6.5 Porous Pavement

Definitions

Pervious concrete consists of specially formulated mixtures of Portland cement; uniform, open-graded, coarse aggregate such as FDOT No. 8 or No. 89 (3/8 inch) (10 mm) to No. 5 or No. 56 (1 inch) (25 mm); and potable water. This material may be combined with certain water-reducing and retarding or accelerating admixtures, along with air-entraining agents. When properly handled and installed, pervious concrete has a high percentage of void space that allows liquids to percolate rapidly through the pavement (see **Figure 6.5**).

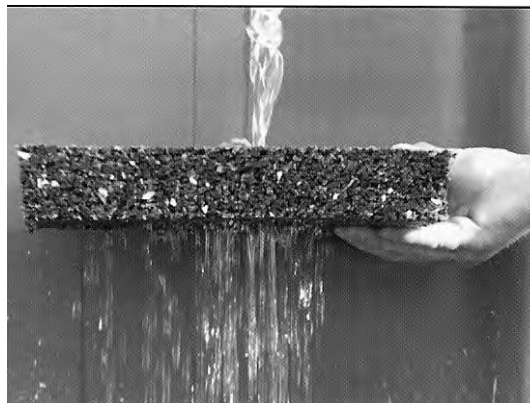

Purposes

1. *To reduce the volumes and peak rates of runoff normally associated with urban development, thus reducing the potential for combined sewer overflows, downstream channel erosion, and subsequent sediment pollution.*
2. *To improve water quality by filtration and bacterial action.*
3. *To aid in ground water recharge.*

Conditions Where Practice Applies

Theoretically, the practice can be applied as a direct substitute for conventional concrete pavements wherever onsite retention is necessary to control runoff rates, volumes, and/or quality. However, it is most popular for low-volume traffic areas, such as parking areas, with stable subgrade soils having at least moderate permeability. The practice should have a wider range of application in areas with very sandy soils.

Several regulatory agencies in Florida have restricted the use of porous pavement due to failures resulting from a lack of maintenance. The use of this practice should be limited to entities that have demonstrated a capability to maintain the pavement and/or the ability to restrict access to vehicles that have taken precautions such as tire washing. An operating permit (2 to 5 years duration) based on regular performance inspection is another method to safeguard the effectiveness of this practice.

Construction Specifications

The subgrade shall be prepared following standard practices as described in **EARTHWORK SPECIFICATIONS** (in this chapter) and as directed by a Florida registered professional engineer. Light equipment or low ground pressure equipment should be used to avoid compacting the subsoil. Mixing and placement shall be performed by qualified contractors under the direction of a professional engineer.

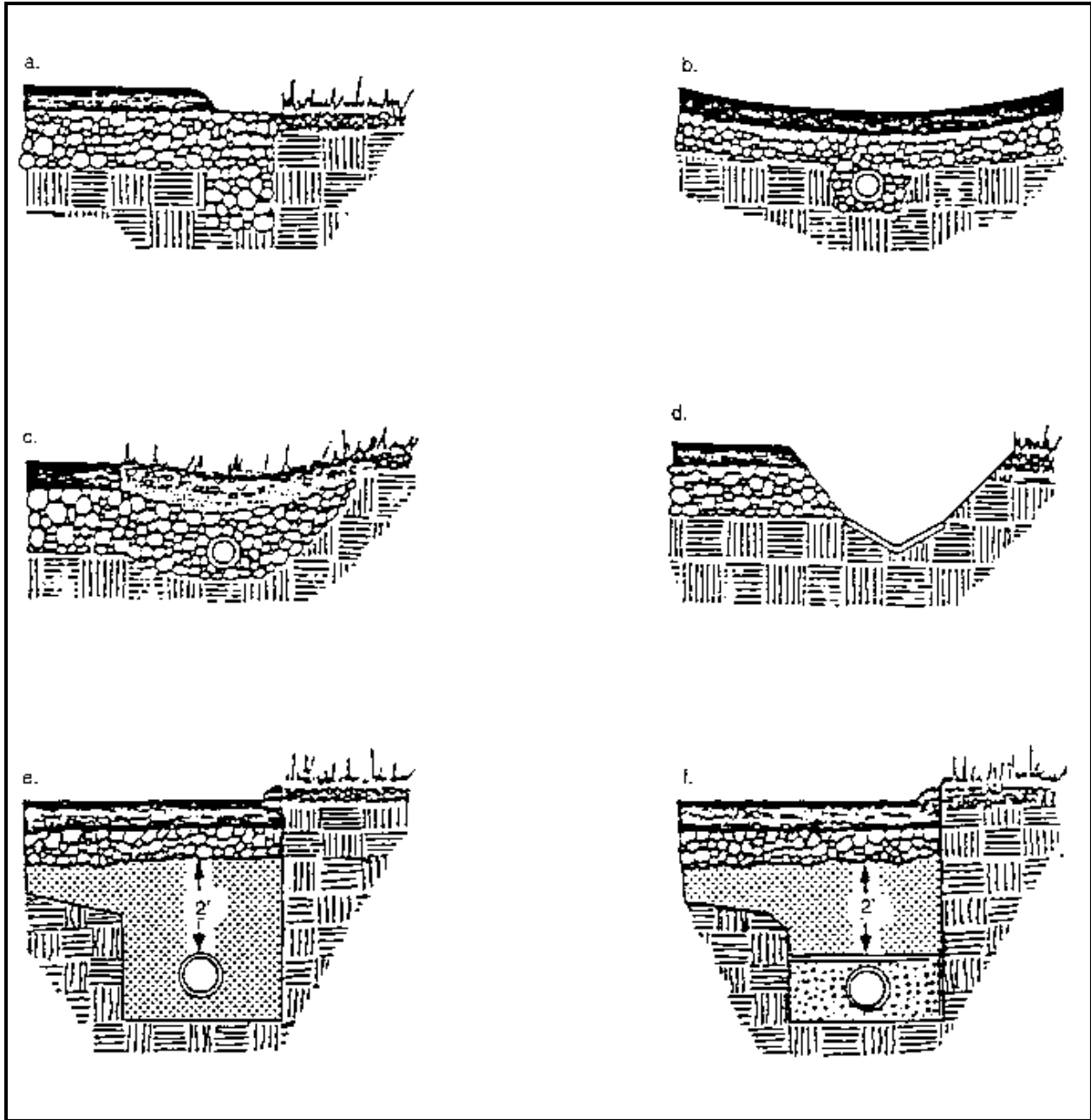

Figure 6.5. Examples of Porous Pavement Drainage Systems

Source: Thelen et al., 1972

6.6 Concrete Grid and Modular Pavement

Definition

A pavement consisting of strong structural materials with regularly interspersed void areas that are filled with pervious materials, such as sod, gravel, or sand (see **Figure 6.6**).

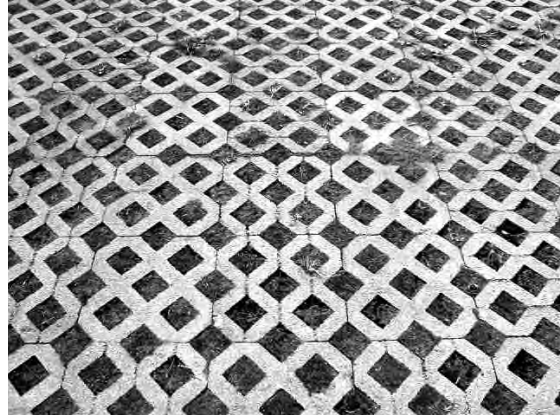

Purpose

To reduce water pollution from low-volume traffic areas by providing a bearing surface strong enough to accommodate vehicles, while allowing the infiltration of surface water and filtration of pollutants. It achieves this purpose by the following:

1. *Reducing the volume and peak rate of runoff flow, thus reducing the likelihood of sewer overflows, flooding, and downstream erosion and sediment pollution.*
2. *Reducing the loading and concentration of pollutants in runoff.*

Conditions Where Practice Applies

The practice is used where pavement is desirable or required for low-volume traffic areas and the underlying soils allow for rapid drainage. It is most applicable for new construction but can be used in existing developments to expand a parking area or even to replace existing pavement, if that is a cost-effective measure. It should **NOT** be used in areas where infiltrated pollutants may reach and degrade ground water.

Possible areas for the use of these paving materials include the following:

1. *Parking lots, especially fringe or overflow parking areas.*
2. *Parking aprons, taxiways, blast pads, and runway shoulders at airports (heavier loads may demand the use of reinforced grid systems).*
3. *Emergency stopping and parking lanes and vehicle crossovers on divided highways.*
4. *On-street parking aprons in residential neighborhoods.*
5. *Parking pads in recreational vehicle camping areas.*
6. *Private roads, easement service roads, and fire lanes.*
7. *Industrial storage yards and loading zones (heavier loads may demand the use of reinforced grid systems).*
8. *Driveways for residential and light commercial use.*

9. Sidewalks, patios, and swimming pool aprons.
10. Boat ramps, bike paths, and nature trails.

Construction Specifications

The subgrade shall be prepared following standard practices as described in **EARTHWORK SPECIFICATIONS** (in this chapter) and as directed by a Florida registered professional engineer. Light equipment or low ground pressure equipment should be used to avoid compacting the subsoil. Grid or modular pavement shall be installed according to the manufacturer's specifications. The void spaces can be filled with sand or gravel, or vegetated according to the practices described in **Chapter 7**.

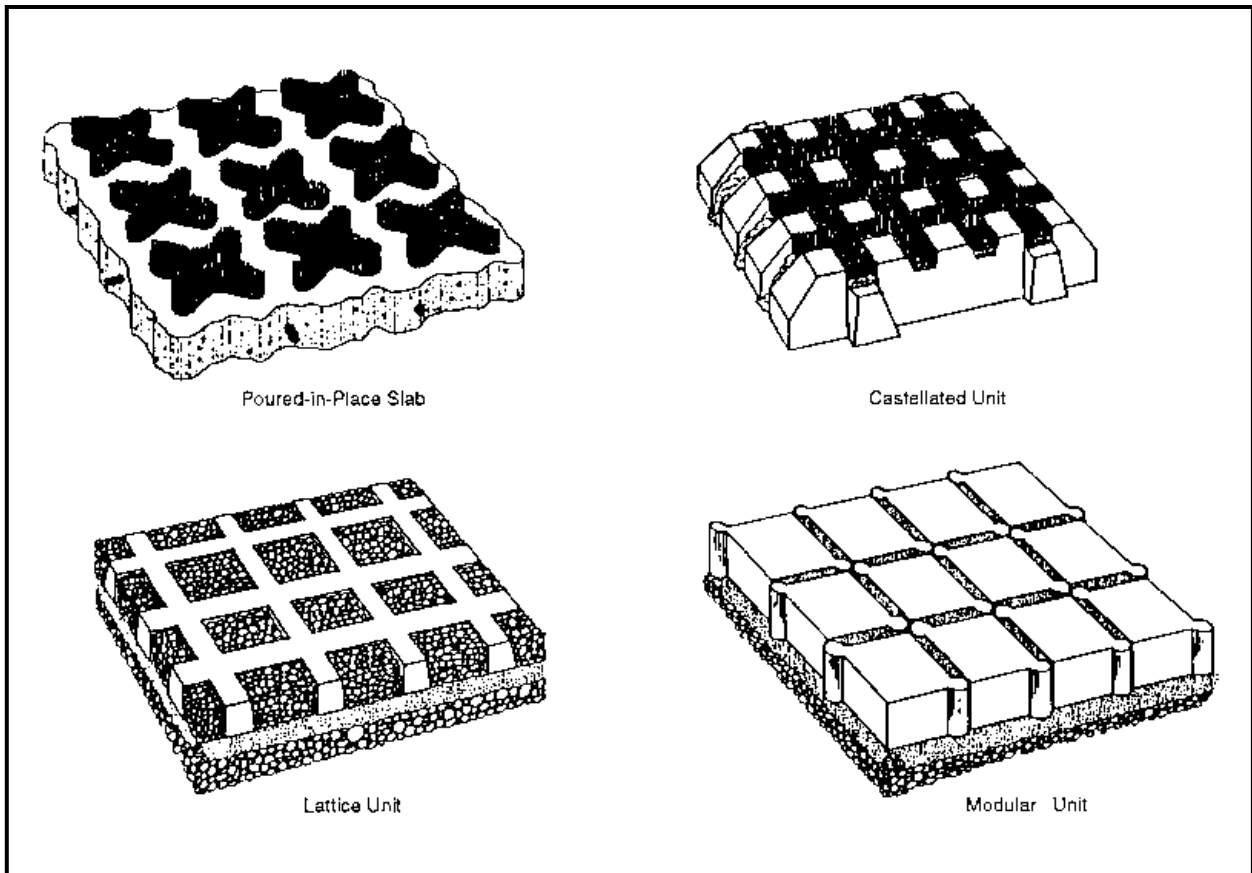

Figure 6.6. Types of Grid and Modular Pavement

Source: Virginia SWCC

6.7 Stormwater Detention Basin

Definition

Onsite stormwater detention refers to the temporary storage of excess runoff on a site before its gradual release after the peak of the storm inflow has passed. Runoff is held for a short period and is slowly released to a natural or constructed water course, usually at a rate no greater than the predevelopment peak discharge rate.



Purposes

A detention facility regulates the runoff from a given rainfall event and controls discharge rates to reduce the impact on downstream stormwater systems, either natural or man-made. Generally, detention facilities do not reduce the total volume of runoff but redistribute the rate of runoff over time by providing temporary "live" storage of a certain amount of stormwater. The volume of this temporary storage is the volume indicated by the area between the inflow and outflow hydrographs, as shown in **Figure 6.7a**.

Figure 6.7b shows examples of "dead" storage areas in wet detention ponds. When the inflow and outflow pipes are too close together and directly across the pond from each other, the water shoots straight through the pond without enough time to allow for settling and uptake. The remaining storage capacity of the pond is not being used for storage and settling as it should. This is the "dead" storage area of the pond. One way to alleviate the dead storage is to incorporate earthen berms or baffles to force the water to take a longer flow path to the pond outlet. This provides additional time in the pond for settling and nutrient uptake to occur (see **Chapter 4** for more information on baffles).

The benefits of properly designed and operated detention facilities include a reduction in downstream flooding problems, the reduced costs of downstream stormwater conveyance facilities, a reduction in pollution of receiving streams, and the enhancement of aesthetics in a development area by providing a core of "blue-green" areas for parks and recreation.

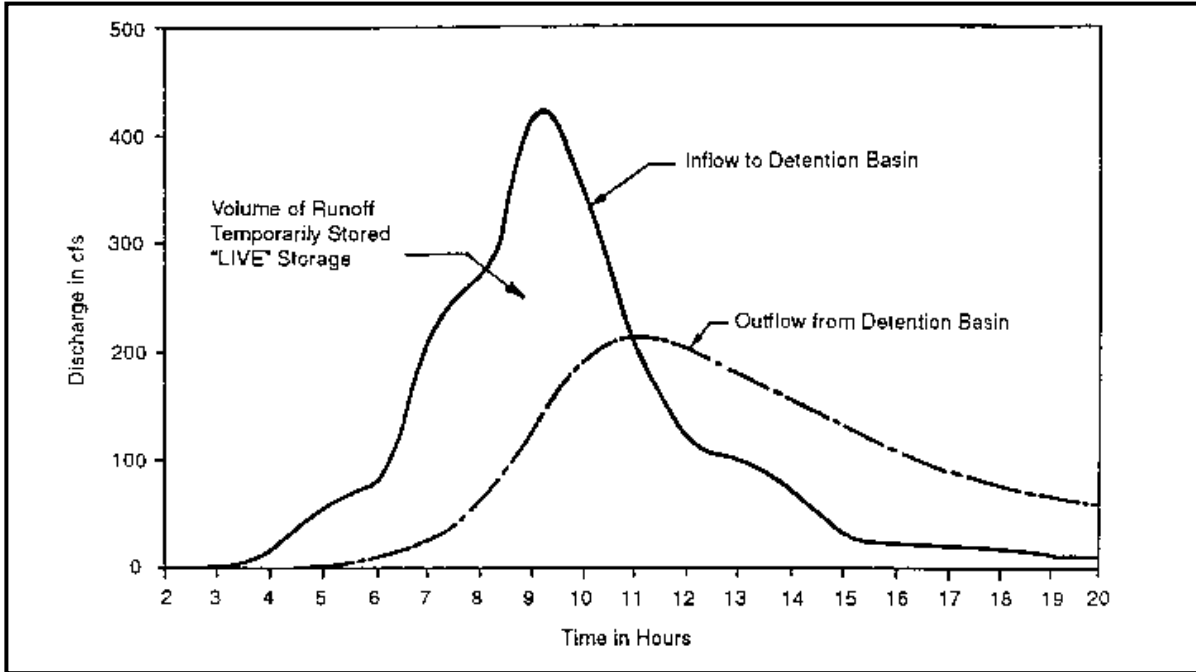

Figure 6.7a. Typical Detention Basin Hydrographs

Source: NRCS

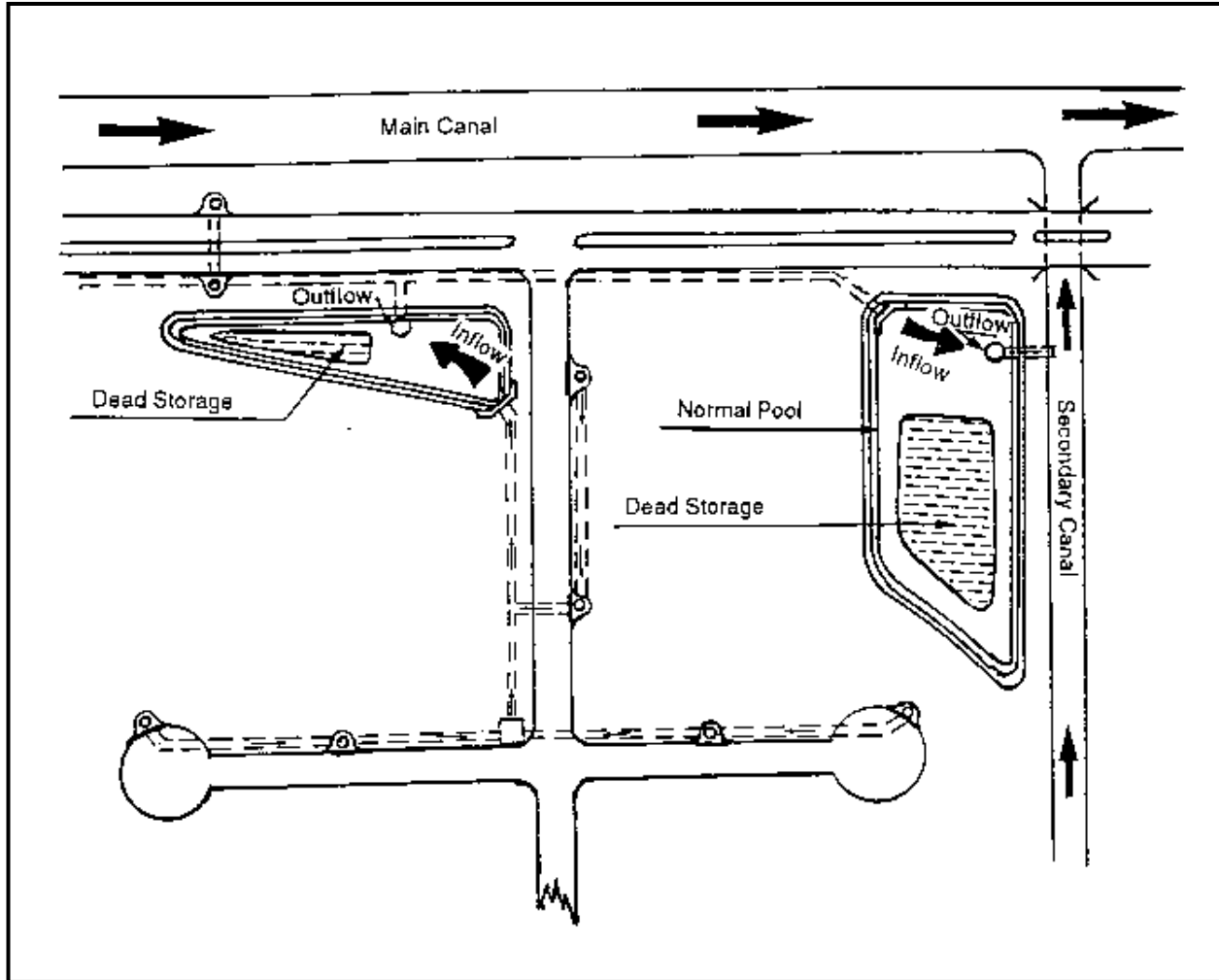

Figure 6.7b. Examples of Dead Storage Areas in Wet Ponds

Source: NRCS

Construction Specifications

Initial basin construction should be carried to within 1 foot (0.3m) of the elevation of the basin floor. Interior side slopes should be sodded immediately to prevent erosion and the introduction of additional sediments. Final excavation shall be deferred until all contributing areas of the watershed are stabilized. **Figures 6.7c** and **6.7d** show examples of different configurations for a wet detention system.

Structural elements, such as embankments, inlets, flumes, and emergency spillways, shall be designed by a Florida registered professional engineer. These elements shall be constructed in accordance with **EARTHWORK SPECIFICATIONS** (in this chapter) and other acceptable engineering standards.

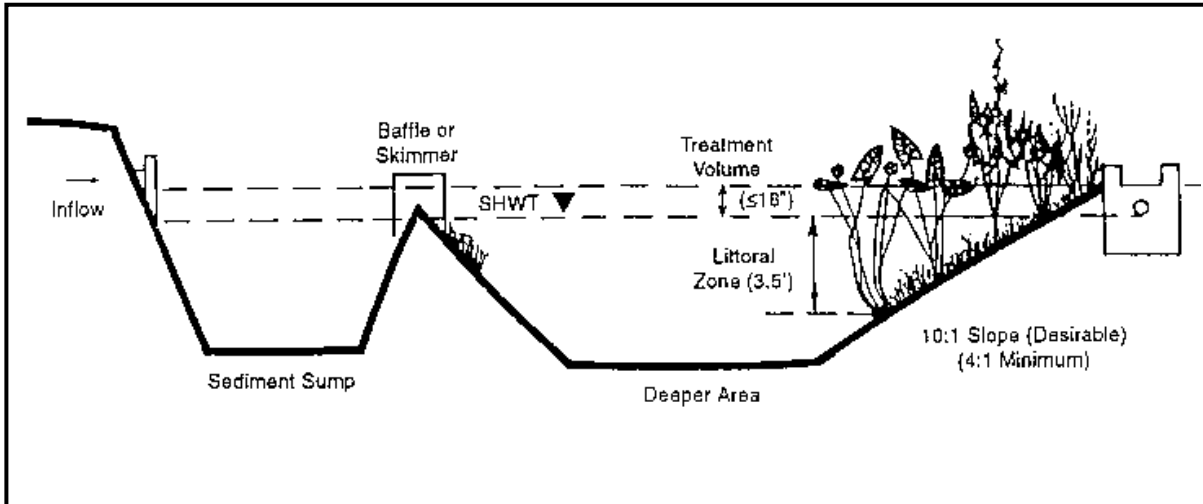

Figure 6.7c. Wet Detention System, Pond Configuration – A

Source: Southwest Florida Water Management District (SWFWMD), 1988

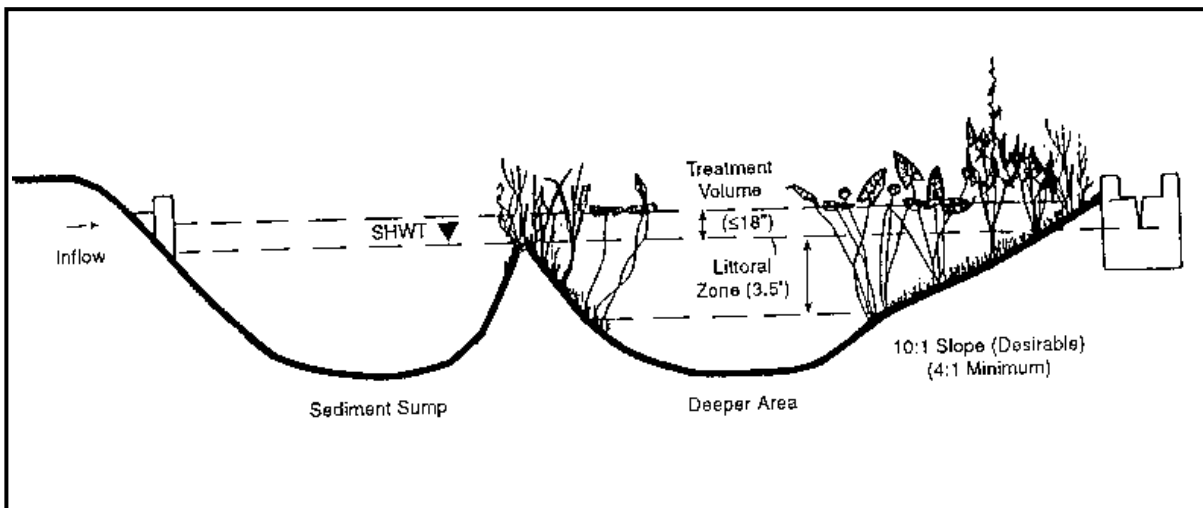

Figure 6.7d. Wet Detention System, Pond Configuration – B

Source: SWFWMD, 1988

6.8 Underdrain and Filtration Systems

Definition

Stormwater underdrain and filtration systems usually consist of a conduit, such as a pipe and/or a gravel-filled trench, that intercepts, collects, and conveys stormwater following infiltration and percolation through the soil, suitable aggregate, and/or filter fabric.

Purposes

In Florida, these systems serve one or more of the following purposes:

1. *To filter a portion (normally ½ to 1 inch) (13 to 25 mm) of the stormwater runoff contained in detention facilities prior to discharge to surface waters*
2. *To alter the soil environment in treatment areas that are not suitable for desired vegetation, usually by regulating the period of inundation, the water table elevation, and/or the inflow of shallow ground water.*
3. *To improve the infiltration and percolation characteristics of the soil in stormwater management facilities when permeability is restricted due to soil texture or a high water table.*



Conditions where Practice Applies

Underdrain systems and filters are used in combination with a variety of stormwater management measures where space, soil permeability, and/or water table conditions dictate that sufficient pollutant removal cannot normally be achieved through natural percolation, sedimentation, or other means. A gravity outlet must be available or pumping must be provided. A pumped discharge usually requires a permit from FDEP and/or the local water management district.

Construction Specifications

All drains shall be laid to line and grade, surrounded by at least 3 inches (8 cm) of washed gravel, and wrapped in filter fabric. The trench bottom must be uniformly smooth and made up of either undisturbed soil or properly compacted fill, especially if the trench is cut into rock. Joints between sections of rigid pipe shall not exceed ¼ inch (3 mm). The ends of pipes shall be capped, or preferably connected to cleanouts. Backfill shall be as outlined in **EARTHWORK SPECIFICATIONS** (in this chapter). **Figures 6.8a** through **6.8e** show additional specifications.

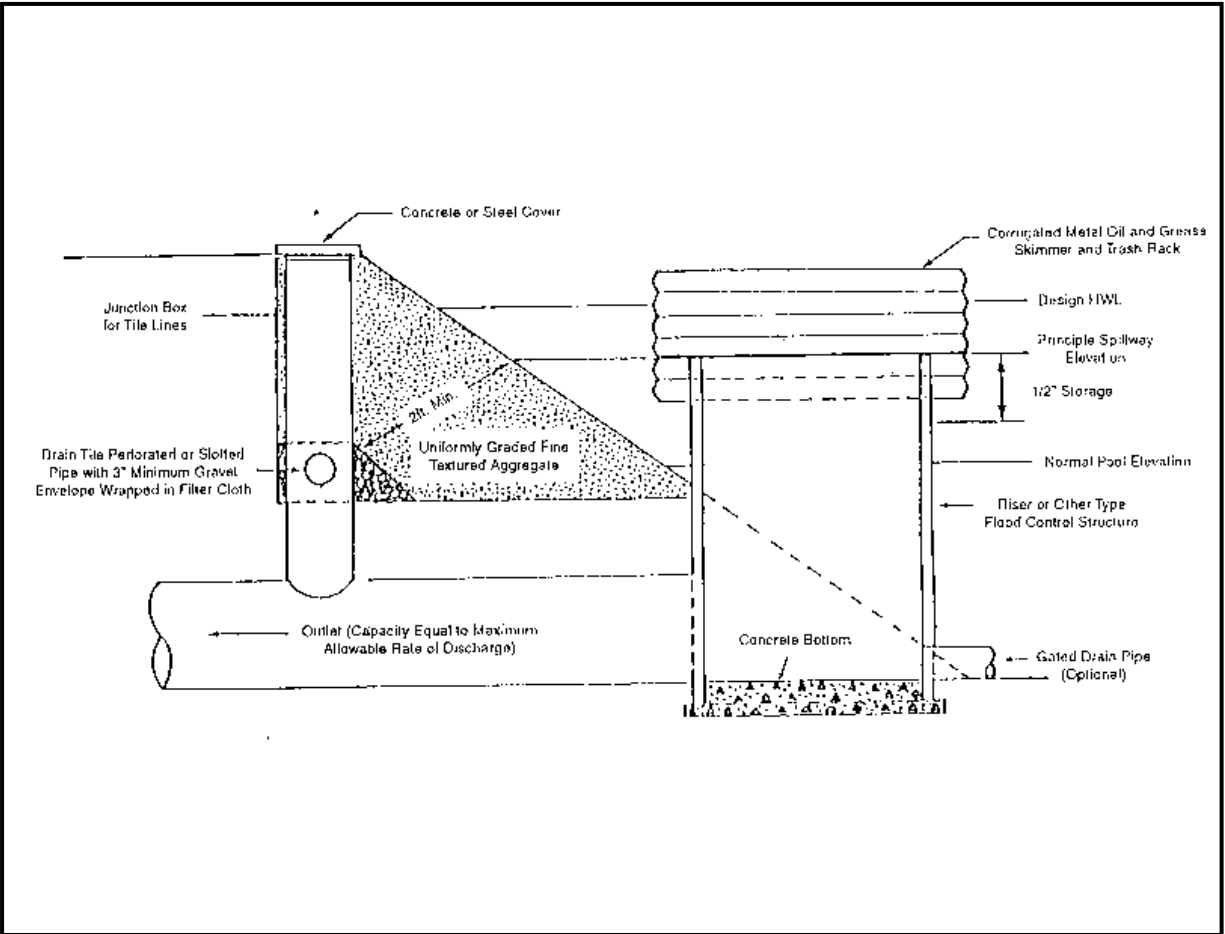

Figure 6.8a. Cross-Section of Stormwater Discharge Structure with "Mixed Media" Bank Filter System

Source: NRCS

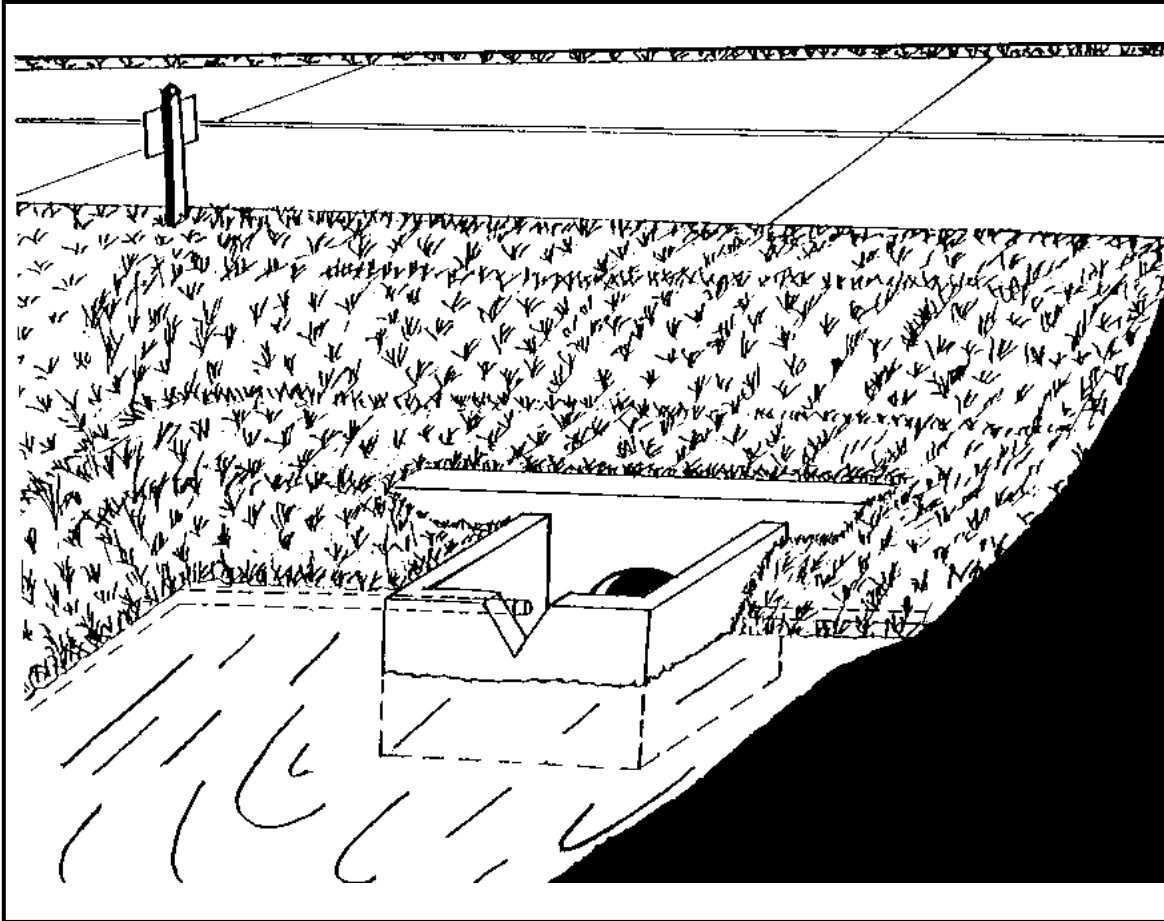

Figure 6.8b. Illustration of Typical "Natural Soil" Bank Filtration System with Box Inlet Drop Spillway and "V" Notched Weir (Wet Detention Facility)

Source: NRCS

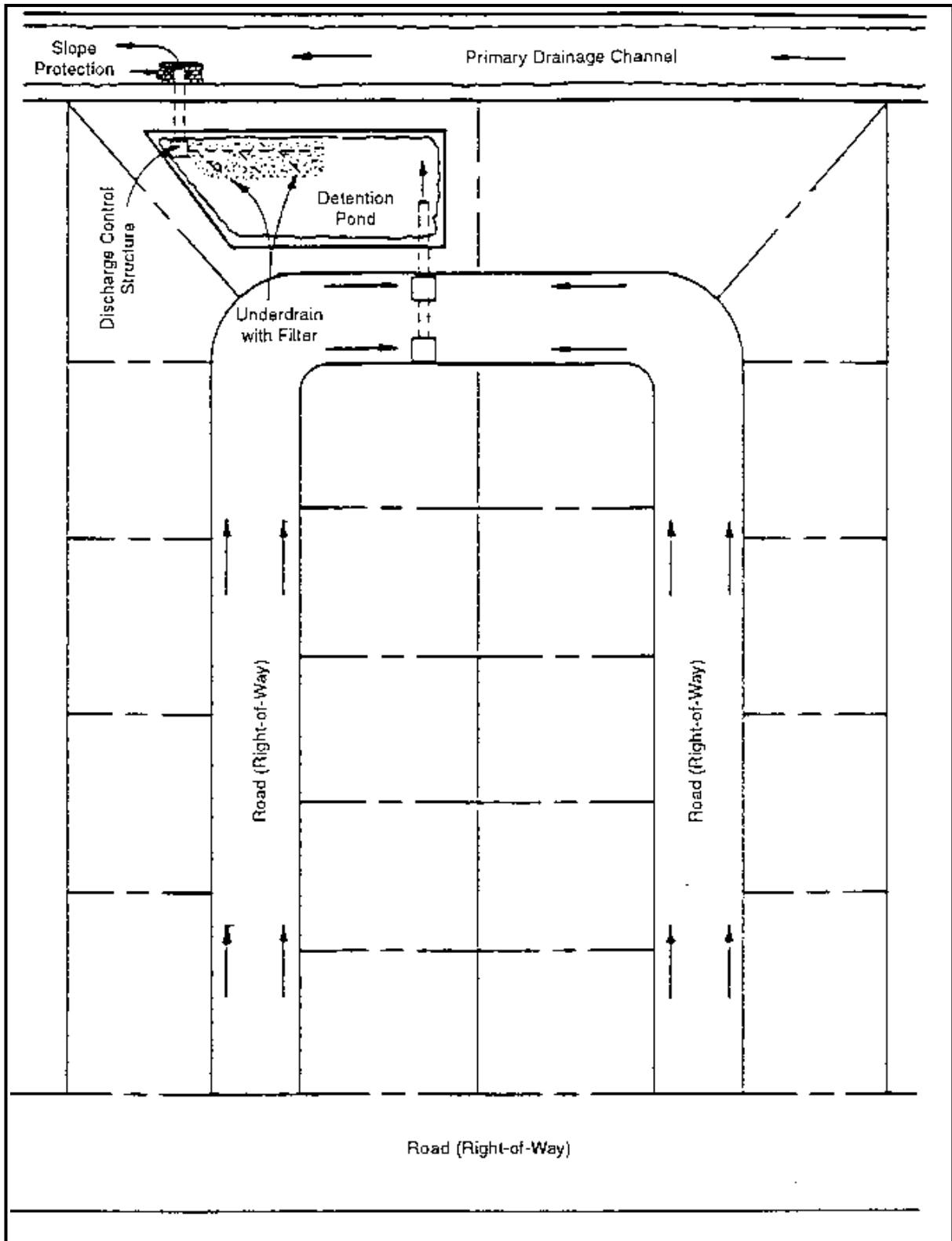

Figure 6.8c. Typical Subdivision Layout Showing On-Line Detention Pond and Outfall

Source: Pinellas Park Water Management District

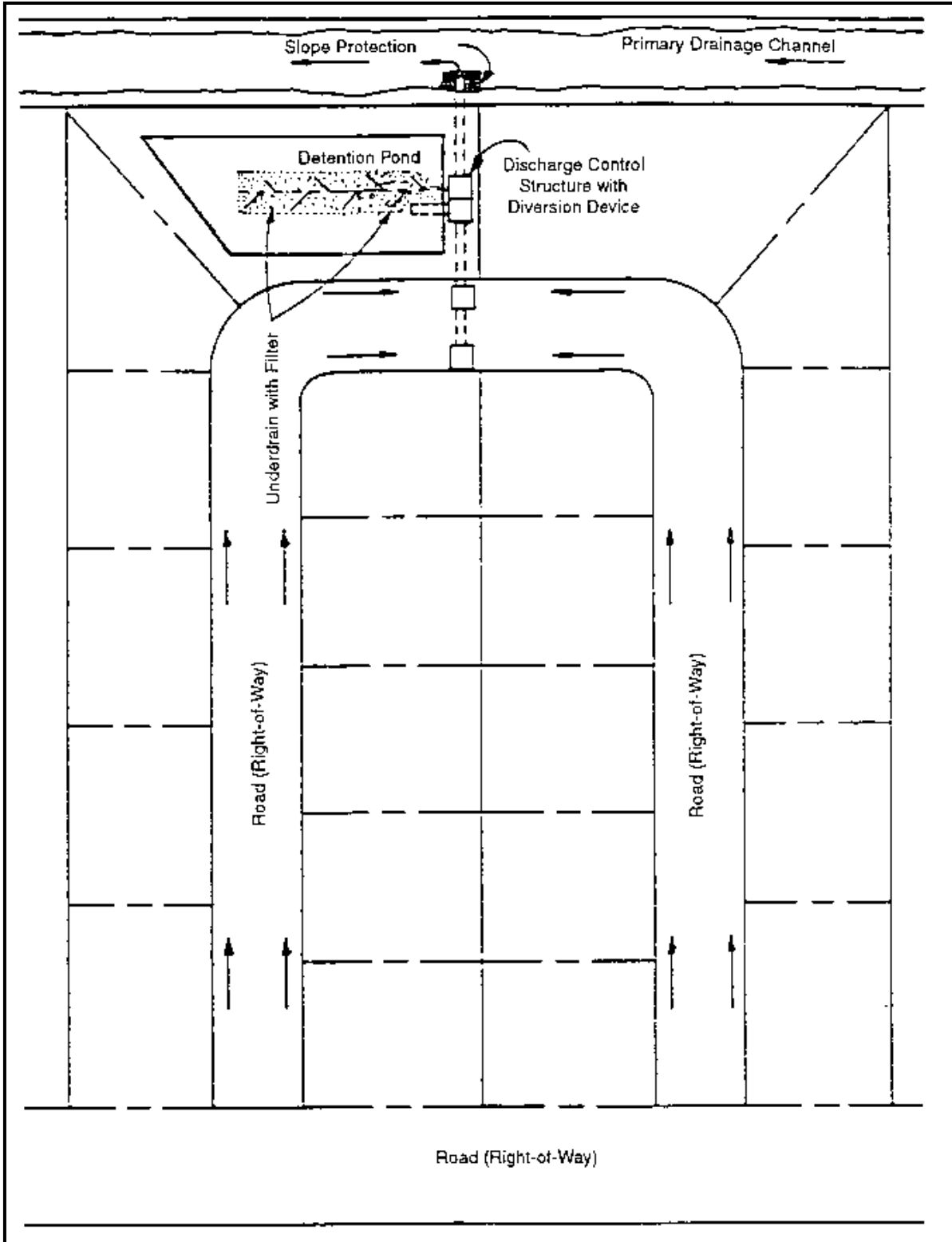

Figure 6.8d. Typical Subdivision Layout Showing Off-Line Detention Pond and Outfall

Source: Pinellas Park Water Management District

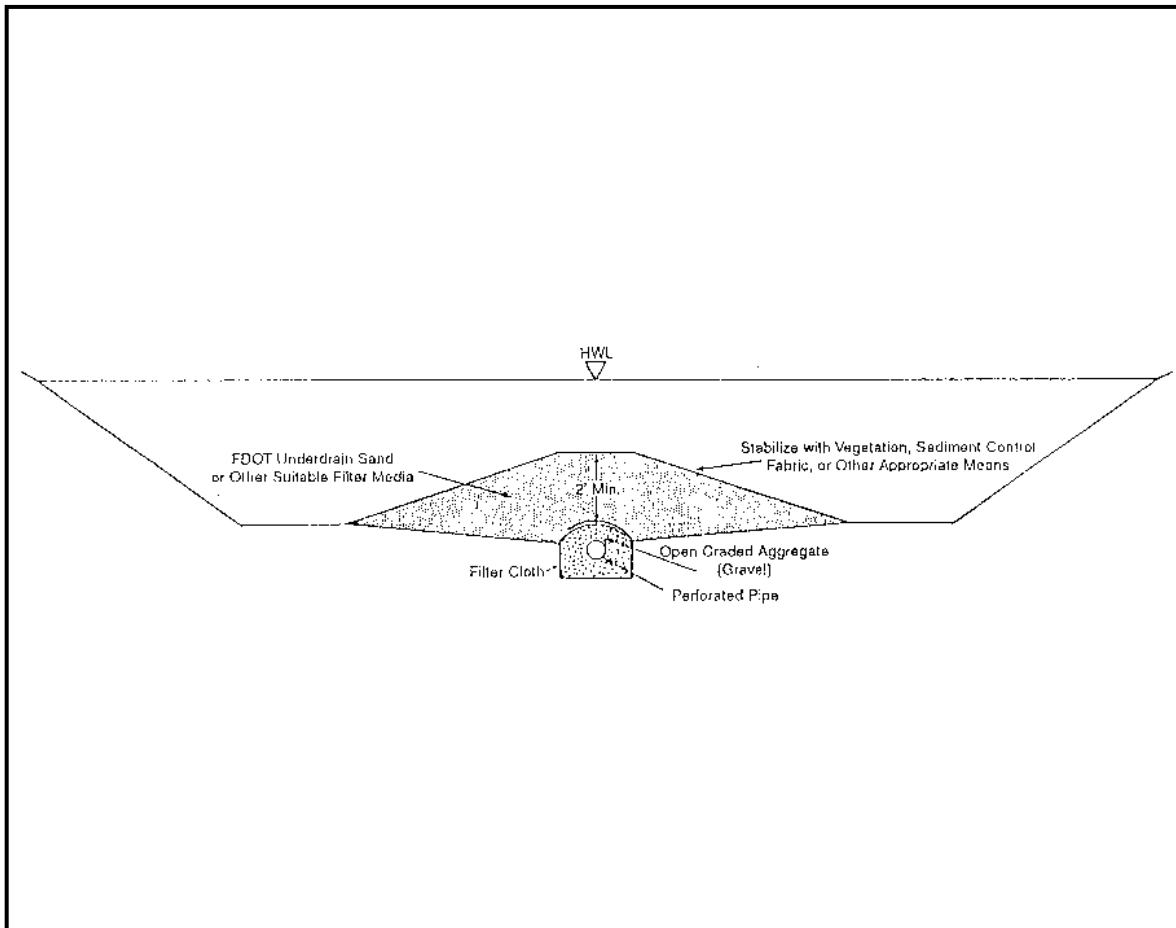

Figure 6.8e. Typical Cross-Section of Elevated Sand Filter for Stormwater Treatment Used in Conjunction with Dry Detention Facility

Source: NRCS

6.9 Swales

Definition

1. Swales (or grassed waterways) are constructed conveyances shaped or graded to the required dimensions and established with suitable vegetation for the safe disposal and treatment of runoff (see **Figures 6.9a** and **6.9b**).
2. Chapter 403, F.S., further defines the term "swale" as requiring a cross-section with a top width-to-depth ratio of 6:1 or greater, or side slopes of 3 horizontal to 1 vertical or flatter. It also specifies that the conveyance must only contain standing or flowing water following a storm, must be planted with or have stabilized vegetation, and must be designed to prevent erosion and reduce pollutant concentrations.



Purposes

1. Swales are used primarily to convey stormwater safely without erosion.
2. It is the usual practice to use existing topographic draws and rework them as needed.
3. With slight modifications to increase the retention and infiltration of runoff, swales can be used to treat and remove pollutants from stormwater runoff in urban situations.

Conditions Where Practice Applies

Swales are used at all sites where added capacity, vegetative protection, or both, are required to control erosion and/or reduce the pollutant load from concentrated stormwater runoff. They are also used as a pretreatment BMP in combination with other BMPs. Examples of uses include the following:

1. Providing outlets for diversions and terraces.
2. Providing conveyances to, or outlets from, surface and subsurface detention and filtration systems.
3. Conveying and treat stormwater collected along roadways or discharged from residential buildings, yards, and vehicle use areas.
4. Rehabilitating or stabilizing natural draws carrying concentrations of runoff.
5. Providing for, or improving, the percolation and treatment of stormwater.
6. Using as pretreatment practices to reduce stormwater pollutant loads before conveying stormwater to other management practices.

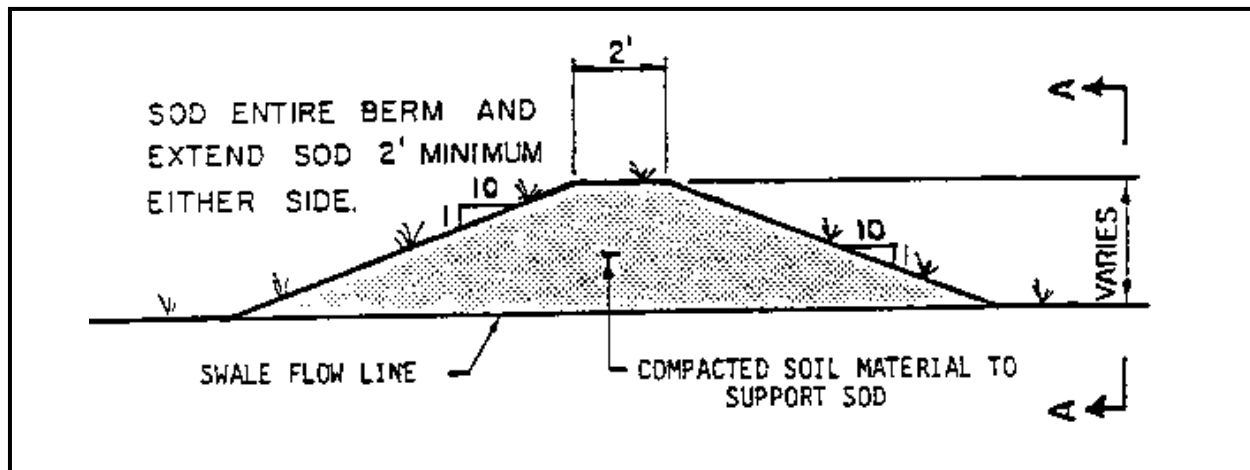

Figure 6.9a. Typical Swale Block Cross-Section

Source: NRCS

Construction Specifications

Equipment

Many kinds of farming and construction equipment can be used for building grassed swales. However, it may be necessary to use equipment that can load and transport the excavated material to locations where it is needed. These points of need might be low spots in the surrounding area or washes in the conveyance that need filling. Small scrapers that can be pulled by farm tractors are satisfactory units for construction. However, large scrapers, bulldozers, and road graders are excellent types of equipment for constructing these systems and may be more efficient.

Site Preparation

The swale should be staked for construction. All trees, stumps, brush, and similar material should be removed from the site and disposed of, so as to not interfere with the proper functioning of the system. Design and construction survey notes should be kept according to standard engineering practice.

Excavation

The soil removed from the swale should be deposited where it will not interfere with the flow of water into the swale. Normally it can be used to fill low spots or build diversions to keep runoff from the swale during vegetation establishment.

The topsoil should be saved and spread in the constructed swale if necessary to ensure the establishment of a good vegetative cover. When this is done, the swale should be over-excavated to allow for the replacement of the topsoil without encroaching on the design cross-section.

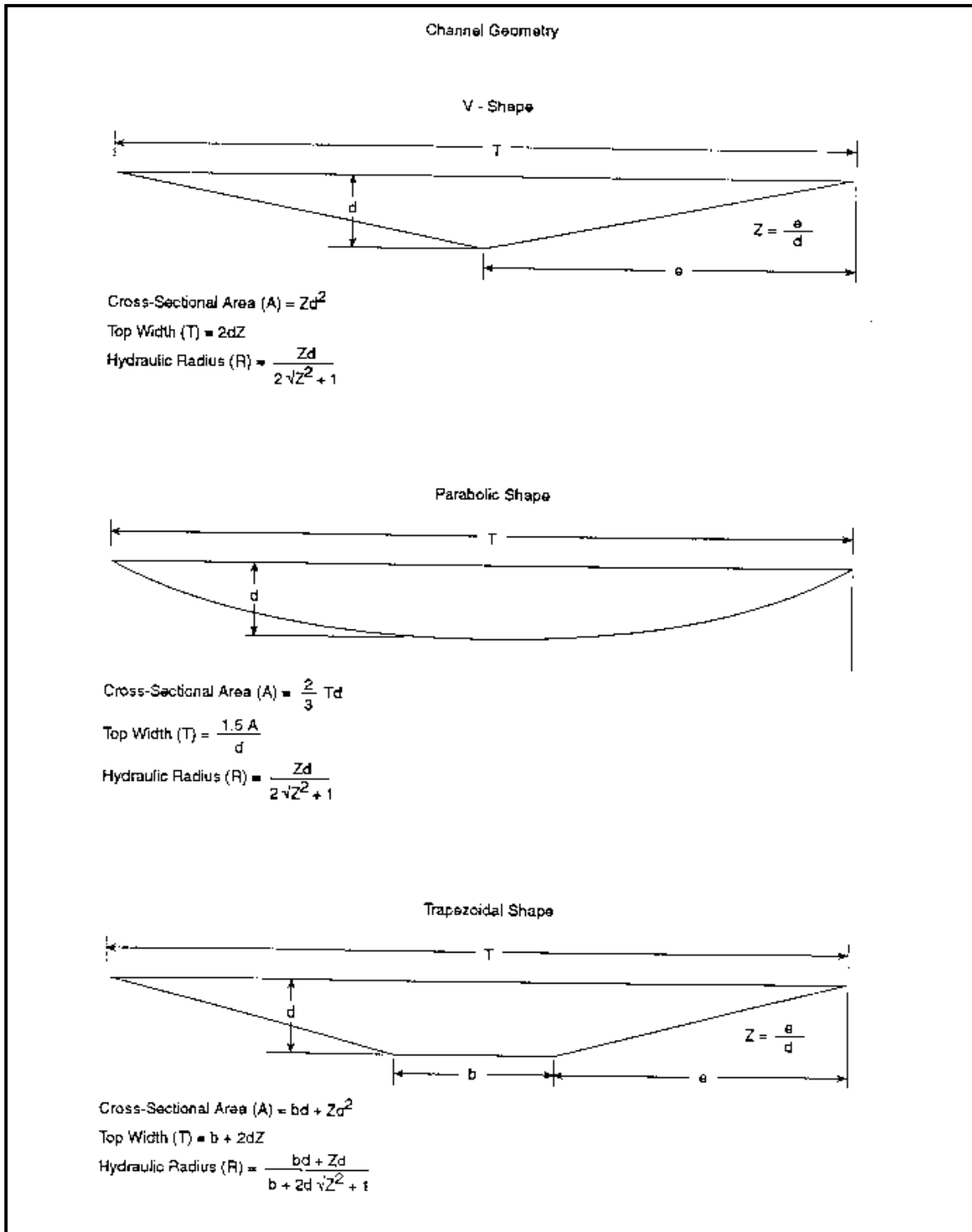

Figure 6.9b. Typical Waterway Shapes and Mathematical Expressions for Calculating Cross-Sectional Area, Top Width, and Hydraulic Radius

Source: NRCS

Establishing Vegetation

The method used to establish grass in a swale depends on the severity of the conditions encountered. **Table 6.1** lists the four different alternatives for grass establishment and the conditions under which each method should be used. For each technique, if any one of the four sets of conditions is exceeded, the next technique below it must be used.

Table 6.1. Grass Establishment Alternatives

Establishment Technique	Conditions
1.a. Hydroseeding	<ol style="list-style-type: none"> 1. Slopes less than 5%. 2. Velocity less than 3 feet (1 m) per second.
1.b. Establishing Bermuda grass by sprigging	<ol style="list-style-type: none"> 1. Majority of drainage can be diverted away from channel during germination and establishment. 2. Erosion-resistant soil.
2. Seeding with straw mulch and jute mesh or erosion netting	<ol style="list-style-type: none"> 1. Slopes less than 5%. 2. Velocity less than 5 feet (1.5 m) per second. 3. Majority of drainage cannot be diverted from channel during germination and establishment. 4. Moderately erodible soil.
3. Sodding	<ol style="list-style-type: none"> 1. Slopes greater than 5%. 2. Velocity between 5 and 6 feet (1.5 to 1.8 m) per second. 3. Majority of drainage cannot be diverted away from channel during germination and establishment. 4. Highly erodible soil.

The details for each alternative are as follows:

- 1.a. **Hydroseeding.** All seeding shall be done in accordance with **PERMANENT SEEDING** (in **Chapter 7**). When mulching, use 2 tons per acre (4.4 t/ha) small grain straw with an acceptable tacking agent (refer to **MULCHING** [in **Chapter 7**]).
- 1.b. **Establishing Bermuda grass by sprigging.** Irrigation water must be available during the first four weeks. Divert drainage away from the channel during the first three weeks of the establishment period by using temporary berms, silt fencing, or straw bale barriers.
2. **Seeding with straw mulch and jute mesh or erosion netting.** In addition to Item 1.a above, secure straw mulch with netting. If using jute mesh, use only 1 ton per acre (2.2 t/ha) small grain straw, evenly distributed. If using a light plastic or paper erosion netting, 1 ½ to 2 tons per acre (3.3 to 4.4 t/ha) of straw is appropriate. Care should be taken to staple the mesh or netting according to the specifications in **MULCHING** (in **Chapter 7**). Many types of erosion control mats and blankets, used alone, are acceptable mulches for the establishment of swales. Some of these products are also pre-seeded.

3. **Sodding.** *When using strip sod, follow the recommendations in **SODDING, Installation, Part D** (in **Chapter 7**). Another suitable product is rolled sod, which comes on rolls 2 to 5 feet (60 to 150 cm) wide and 50 to 100 feet (15 to 30 m) long. The sod is grown through a plastic mesh that offers additional strength and erosion resistance.*

The swale and its outlet shall be protected against erosion by vegetative cover as soon after construction as practical and before diversions or other channels are connected to them.

Details of Swale Block Construction

Swale blocks may be constructed using a variety of materials, including wood, concrete, asphalt, metal, natural soil, or a mixture of each. The most common application is the use of native, in-place soil shaped into the form of a low berm. Regardless of the material or materials chosen to form the restriction, the designer should take proper precautions to ensure that the facility is not subject to undercutting and erosion, especially along its toe.

Figure 6.9a shows a typical cross-section of a berm-type system. Research conducted by the University of Central Florida (UCF) on 3 existing swale block systems indicated that these systems remained in place more than 2 years after their construction. Washout did not occur, even though 3 storms greater than 3 inches (8 cm) were recorded during this period.

Swale block height should be limited to 1.5 feet (45 cm) for public safety and roadway subgrade protection. It is also recommended that the following guidelines be applied to ensure good structural integrity and easy maintenance (mowing):

1. *The front and back slope of the structure should not be steeper than 10 feet horizontal to 1 foot vertical, unless pavement or another equally stable material is used to protect the berm from erosion during overflow conditions.*
2. *Berms should be constructed of clean, stable material suitable for the construction of embankments. The material should be free from tree roots, construction debris, and other extraneous material. The UCF researchers used clayey sand that was mechanically compacted. Inorganic silts, organic silts, and organic clays, as well as peat or other highly organic soil, should not be considered. The designer should also be aware that vegetative cover may be hard to establish when using highly permeable material, such as FDOT washed sand.*
3. *Sod should be used to protect these embankments from erosion. Protection should be provided extending at least 2 feet (60 cm) from the toe of the berm along both the face and back slope of the structure.*

6.10 Stormwater Conveyance Channel

Definition

A permanent, designed waterway, shaped and lined with appropriate vegetation or structural material to safely convey excess stormwater runoff from a developing area.

Purpose

To convey concentrated surface runoff water without damage from erosion.



Conditions Where Practice Applies

The practice is generally applicable to man-made channels, including roadside ditches, and intermittent natural channels that are modified to accommodate increased flows from land development. It is not applicable to major, continuously flowing natural streams.

Construction Specifications

General

1. *All trees, brush, stumps, roots, obstructions, and other unsuitable materials shall be removed and properly disposed of.*
2. *The channel shall be excavated or shaped to the proper grade and cross-section, taking into account the type of channel lining.*
3. *All fills shall be well-compacted to prevent unequal settlement.*
4. *Any excess soil shall be removed and properly disposed of.*

Grass-Lined Channels

Grass shall be established in accordance with **SWALES** (in this chapter) and **Chapter 7** of this manual.

Concrete-Lined Channels

Concrete-lined channels must be constructed in accordance with all applicable FDOT specifications. The following summary is provided only as a guide:

1. *The subgrade should be moist when the concrete is poured.*
2. *Traverse joints for crack control should be provided at approximately 20 foot (6 m) intervals and when more than 45 minutes elapses between the times of consecutive concrete placements. All sections should be at least 6 feet (1.8 m) long. Crack control joints may be formed by using a 1/8 inch (3 mm) thick removable template, by scoring or sawing to a depth*

*of at least ¾ inch (19 mm), or by an approved "leave in" type insert (see **Figure 6.10a**).*

- 3. Expansion joints shall be installed every 100 feet (30 m).*

Riprap-Lined Channels

Riprap shall be installed in accordance with **RIPRAP** (in this chapter) (see **Figure 6.10b**).

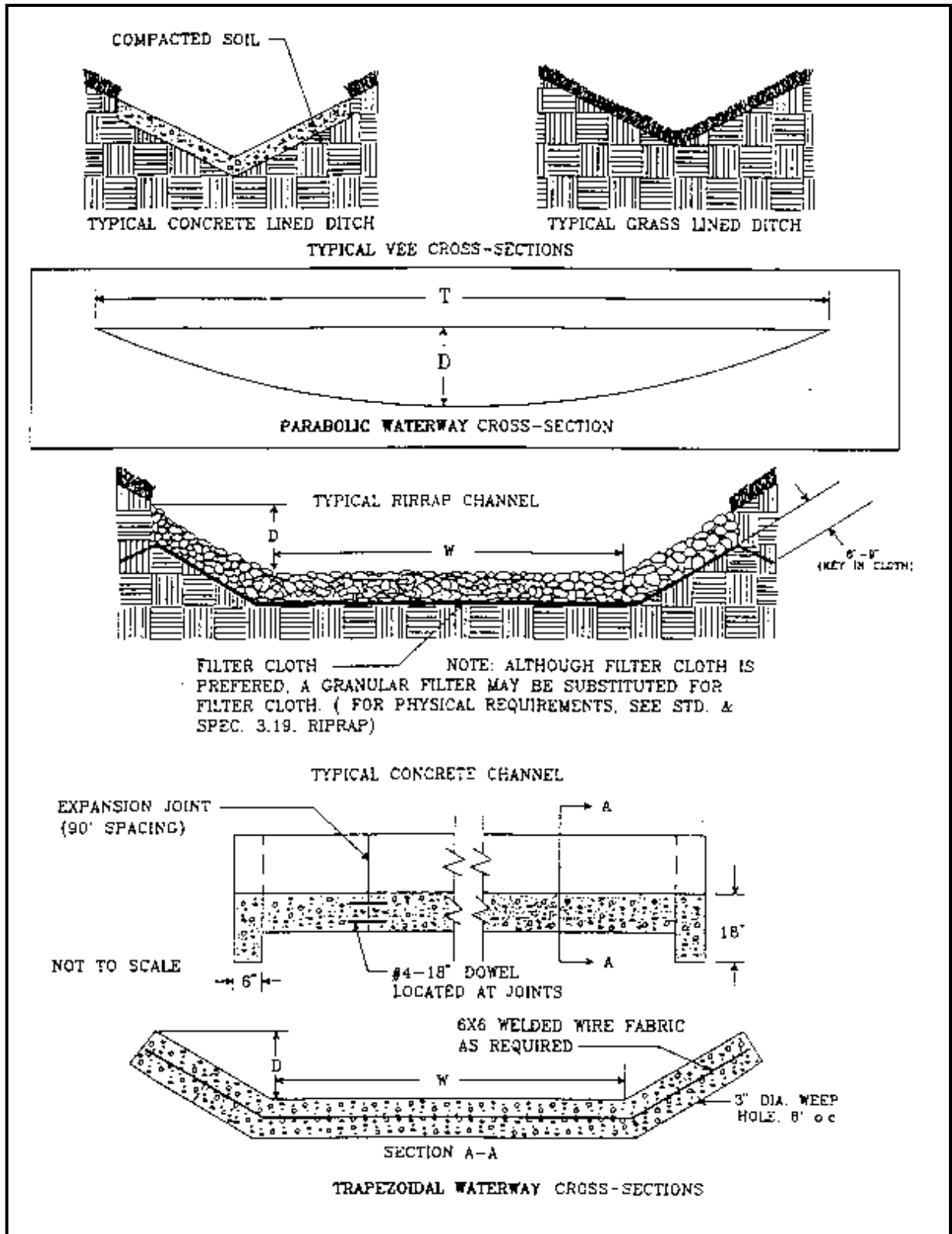

Figure 6.10a. Typical Waterway Cross-Sections

Source: Virginia DSWC

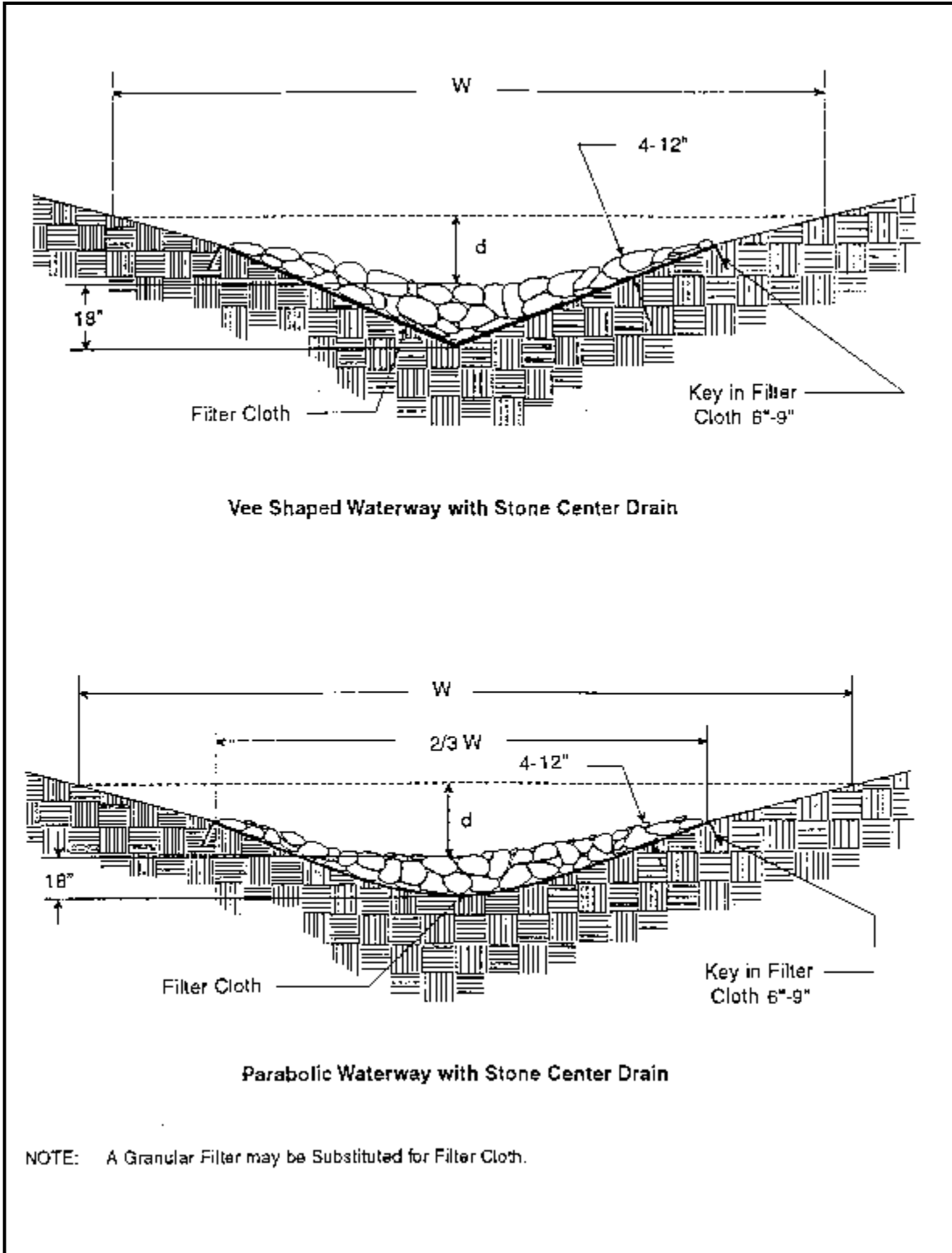

Figure 6.10b. Typical Stone-Lined Waterways

Source: NRCS

6.11 Paved Flume

Definition

A permanent, concrete-lined channel constructed on a slope (see **Figure 6.11**).

Purpose

To conduct stormwater runoff safely down the face of a slope without causing erosion problems on or below the slope.



Conditions Where Practice Applies

The practice is used wherever concentrated stormwater runoff must be conveyed from the top to the bottom of cut or fill slopes on a permanent basis.

Planning Considerations

Paved flumes are used routinely on highway cuts and fills to convey concentrated stormwater runoff from the top to the bottom of a slope without erosion. Fortunately, these structures have equal applicability to cut-and-fill slopes for construction projects other than highways.

Construction Specifications

On steep slopes, paved flumes shall be constructed of concrete on undisturbed soil or properly compacted fill. Trenches for anchor lugs and curtain walls shall be dug by hand. The subgrade should be moist during concrete placement. Curtain walls and anchor lugs should be poured monolithic with the flume slab. If conditions dictate, these may be poured separately, provided that the designing professional engineer approves a proper construction joint with dowels and keyway.

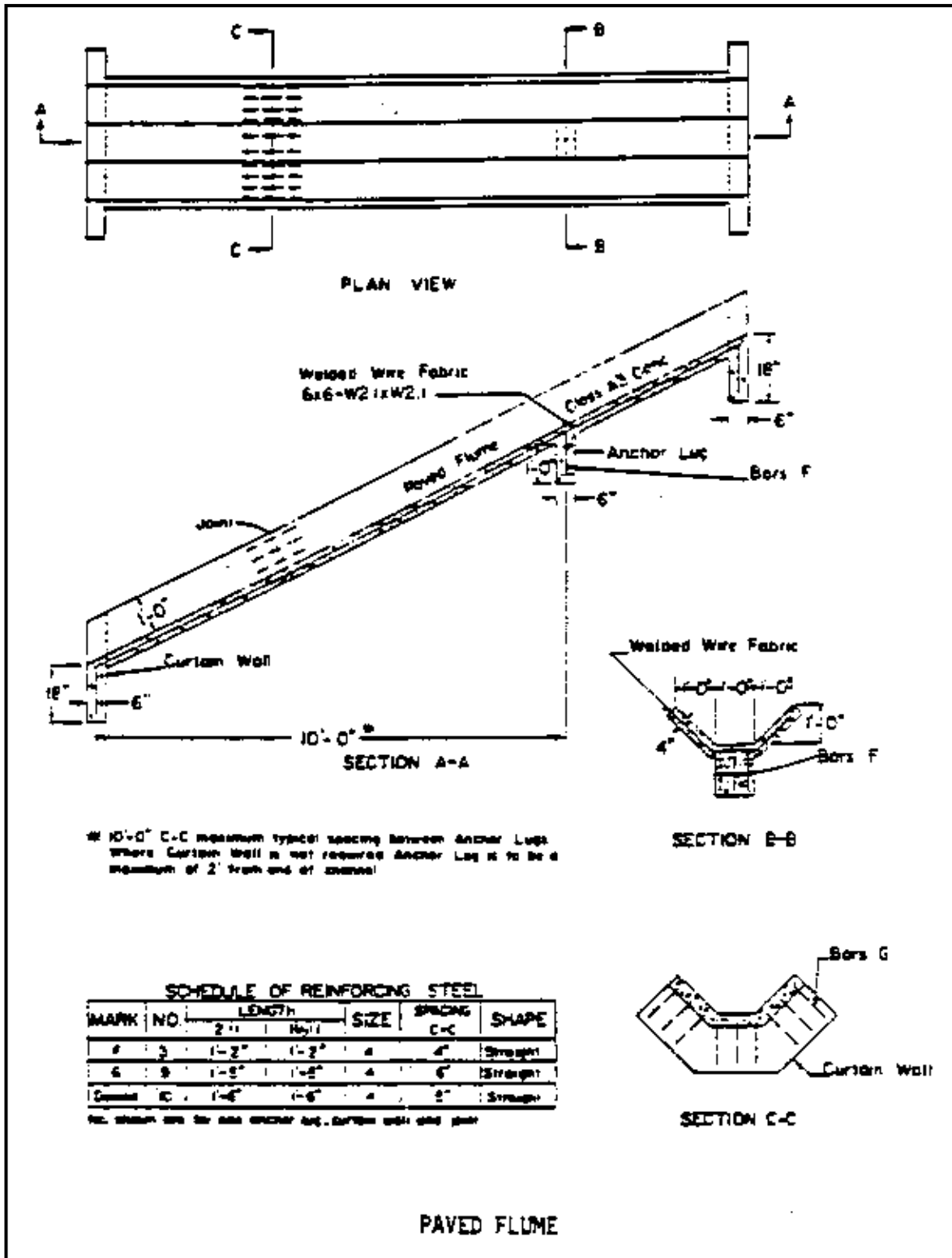

Figure 6.11. Paved Flume

Source: Virginia D&HT

6.12 Diversion

Definition

A channel constructed across a slope with a supporting ridge on the lower side.

Purposes

To reduce slope length and to intercept and divert stormwater runoff to stabilized outlets at non-erosive velocities.



Conditions Where Practice Applies

1. *Where runoff from higher areas may damage property, cause erosion, or interfere with the establishment of vegetation on lower areas.*
2. *Where surface and/or shallow subsurface flow are damaging upland slopes.*
3. *Where the slope length needs to be reduced to minimize soil loss.*
4. *Diversions are applicable only below stabilized or protected areas. They should not be used below high sediment-producing areas, unless land treatment practices or structural measures designed to prevent damaging accumulations of sediment in the channels are installed with or before the diversions.*
5. *Diversions should not be placed on slopes greater than 15%.*

Planning Considerations

Diversions can be useful tools for managing surface water flows and preventing soil erosion. On moderately sloping areas, they may be placed at intervals to trap and divert sheetflow before it has a chance to concentrate and cause rill and gully erosion. They may be placed at the top of cut or fill slopes to keep runoff from upland drainage areas off the slope. They can also be used to protect structures, parking lots, adjacent properties, and other special areas from flooding.

Diversions are preferable to other types of constructed stormwater conveyance systems because they more closely simulate natural flow patterns and characteristics. Flow velocities are generally kept to a minimum. When properly integrated into the landscape design of a site, diversions can be visually pleasing as well as functional.

As with any earthen structure, it is very important to establish adequate vegetation as soon as possible after installation. It is equally important to stabilize the drainage area above the diversion so that sediment will not enter and accumulate in the diversion channel.

Diversions should be constructed before clearing and grading operations begin. If used to protect a flat, exposed area, a diversion might be constructed as a dike or berm. Berms made of gravel or stone can be crossed by construction equipment.

Design Criteria

Location

A diversion's location shall be determined by considering outlet conditions, topography, land use, soil type, length of slope, seepage planes (where seepage is a problem), and development layout.

Capacity

1. *The diversion channel must have a minimum capacity to carry the runoff expected from a 10-year storm with a freeboard of at least 0.3 foot (10 cm) (see **Figure 6.12**).*
2. *Diversions designed to protect homes, schools, industrial buildings, roads, parking lots, and comparable high-risk areas, and those designed to function in connection with other structures, shall have sufficient capacity to carry peak runoff expected from a storm frequency consistent with the hazard involved.*
3. *The peak rates of runoff used in determining the capacity requirements shall be as outlined in **Chapter 3** of this manual or by other accepted methods.*

Channel Design

The diversion channel may be parabolic, trapezoidal, or V-shaped, and shall be designed and constructed according to **STORMWATER CONVEYANCE CHANNEL** (in this chapter) (see **Figure 6.12**).

Ridge Design

The supporting ridge cross-section shall meet the following criteria (see **Figure 6.12**):

1. *The side slopes shall be no steeper than 2:1 and shall be flat enough to ensure ease of maintenance of the structure and its protective vegetative cover.*
2. *The width at the design water elevation shall be a minimum of 4 feet.*
3. *The minimum freeboard shall be 0.3 foot (10 cm).*
4. *The design shall include a 10% settlement factor.*

Outlets

Diversions shall have stabilized outlets that will convey concentrated runoff without erosion. Acceptable outlets include **PAVED FLUME**, **STORMWATER CONVEYANCE CHANNEL**, and **OUTLET PROTECTION** (in this chapter). Outlets shall be constructed and stabilized prior to the operation of the diversion.

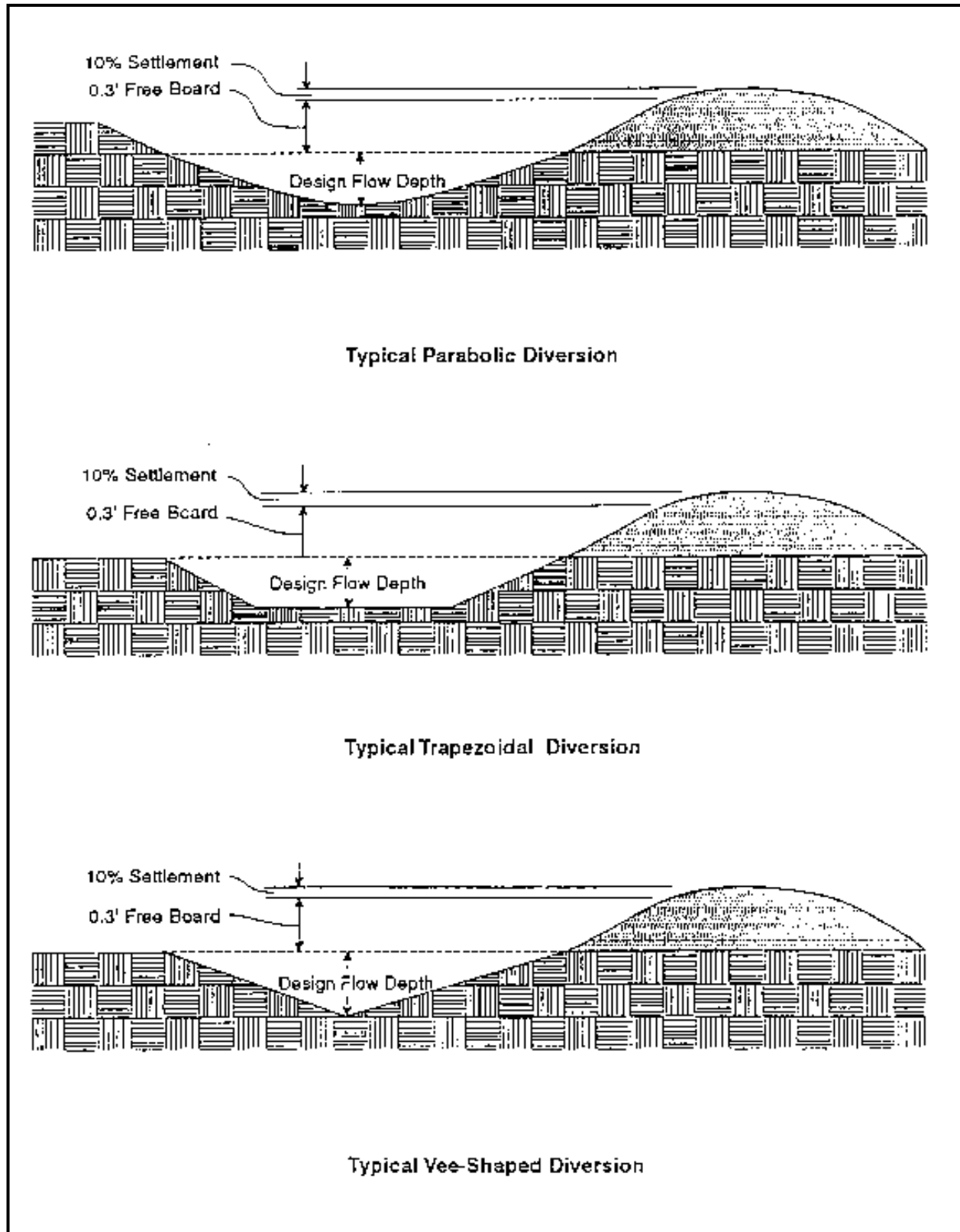

Figure 6.12. Types of Diversions

Source: Virginia DSWC

Stabilization

1. *Unless otherwise stabilized, the ridge and channel shall be seeded and mulched within 15 days of installation in accordance with **PERMANENT SEEDING** (in **Chapter 7**).*
2. *Disturbed areas draining into a diversion shall be seeded and mulched prior to or at the time the diversion is constructed.*
3. *Permanent diversions should include a filter strip of close-growing grass maintained above the channel. The width of the filter strip, measured from the center of the channel, shall be one-half the channel width plus 15 feet (4.5 m).*

Construction Specifications

1. *All trees, brush, stumps, debris, and other obstructions shall be removed and disposed of so as not to interfere with the proper functioning of the diversion.*
2. *The diversion shall be excavated or shaped to line, grade, and cross-section as required to meet the criteria specified here, free of irregularities that will impede flow.*
3. *Fills shall be compacted as needed to prevent unequal settlement that would cause damage in the complete diversion.*
4. *All earth removed and not needed in construction shall be spread or disposed of so that it will not interfere with the functioning of the diversion.*
5. *The permanent stabilization of disturbed areas shall be done in accordance with the applicable standards and specifications in this manual. Permanent stabilization techniques include **PERMANENT SEEDING** and **SODDING** (in **Chapter 7**).*

6.13 Check Dam

Definition

Small dams constructed across a swale or other stormwater conveyance.



Purpose

To reduce the velocity of concentrated stormwater flows, thus reducing erosion of a swale or channel. This practice also traps small amounts of sediment generated in the conveyance itself. However, it is not a sediment-trapping practice and should not be used as such.

Conditions Where Practice Applies

The practice is limited to use in small, open channels that drain 10 acres (4 ha) or less. It should not be used in a live stream. Check dams are especially applicable to sloping sites where the gradient of waterways is close to the maximum for a grass lining. Specific applications include the following:

1. *In constructed conveyances or swales to facilitate the establishment of a permanent non-erodible lining, reduce erosion potential, and reduce maintenance.*
2. *In natural conveyances where increased flows are expected as a result of development activities.*

Construction Specifications

No formal design is required for check dams. They can be used as temporary or permanent structures. Check dams may be designed by an engineer and appear on the stormwater management plan, or they may be installed by the contractor on an "as required" basis. In any case, the following criteria should be adhered to when constructing check dams:

- *The drainage area of the ditch or swale being protected should not exceed 10 acres (4 ha). The maximum height of the check dam should be 2 feet*

(60 cm). The center of the check dam must at least 6 inches (16 cm) lower than the outer edges.

- The maximum spacing between the dams should be such that the toe of the upstream dam is at the same elevation as the top of the downstream dam (see **Figure 6.13**).
- Stone check dams should be constructed of FDOT Aggregate No. 1 (2 to 3 inch) (5 to 8 cm) stone. Hand or mechanical placement is necessary to completely cover the ditch or swale and to ensure that the center of the dam is lower than the edges.

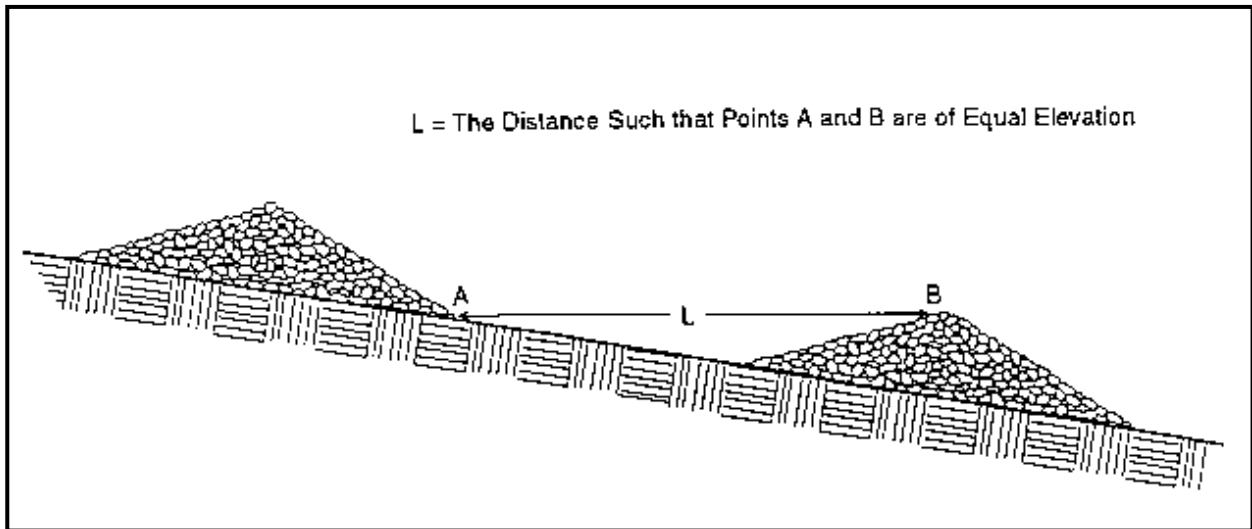

Figure 6.13. Spacing Between Check Dams

Source: Virginia DSWC

6.14 Outlet Protection

Definition

Structurally lined aprons or other acceptable energy-dissipating devices placed at the outlets of pipes (see **Figures 6.14a, 6.14b, and 6.14c**) or paved channel sections (see **Figure 6.14d**). The most common types are riprap aprons or concrete aprons with energy dissipator blocks or walls.



Purposes

To prevent scour at stormwater outlets and to minimize the potential for downstream erosion by reducing the velocity of concentrated stormwater flows.

Conditions Where Practice Applies

Applicable to the outlets of all pipes and paved channel sections where the velocity of flow at design capacity of the outlet exceeds the permissible velocity of the receiving channel or area.

Construction Specifications

Subgrade preparation for all types of outlet protection shall follow the guidelines in **EARTHWORK SPECIFICATIONS** (in this chapter). Riprap outlet protection aprons shall be installed in accordance with **RIPRAP** (in this chapter). Underlying geotextiles shall be anchor trenched in at least 6 to 9 inches (15 to 25 cm) and backfilled.

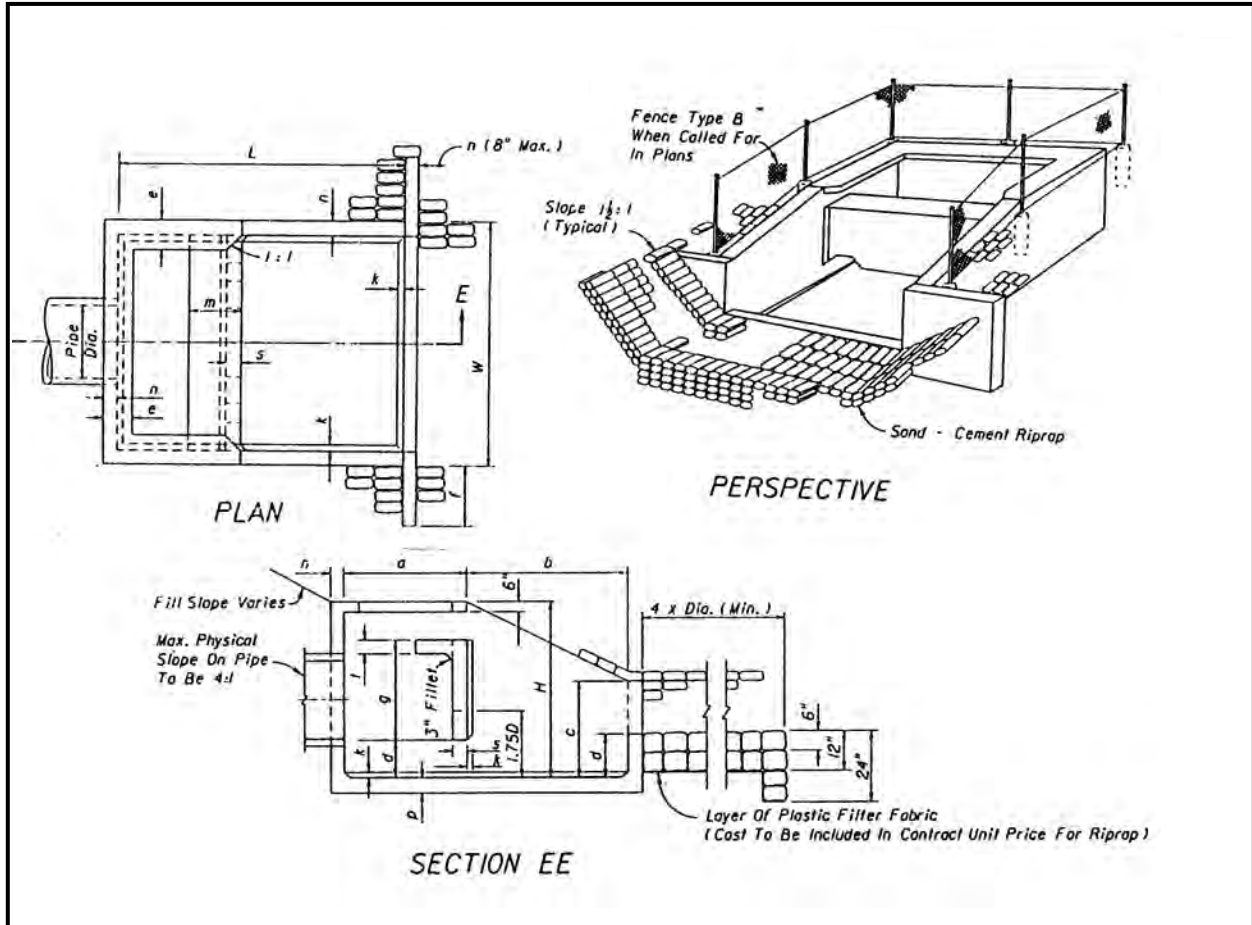

Figure 6.14a. Energy Dissipator

Source: FDOT

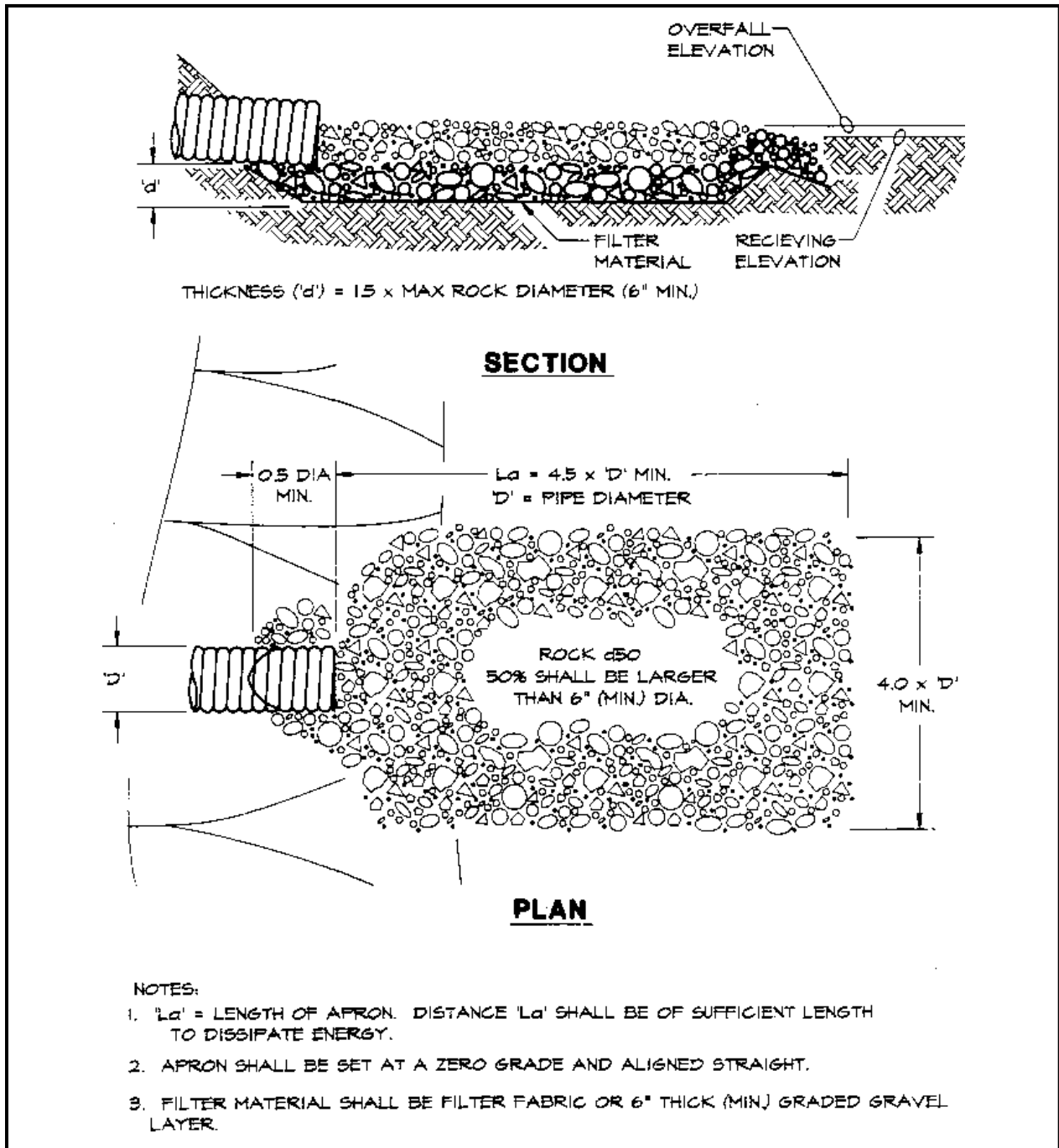

Figure 6.14b. Energy Dissipator

Source: Erosion Draw

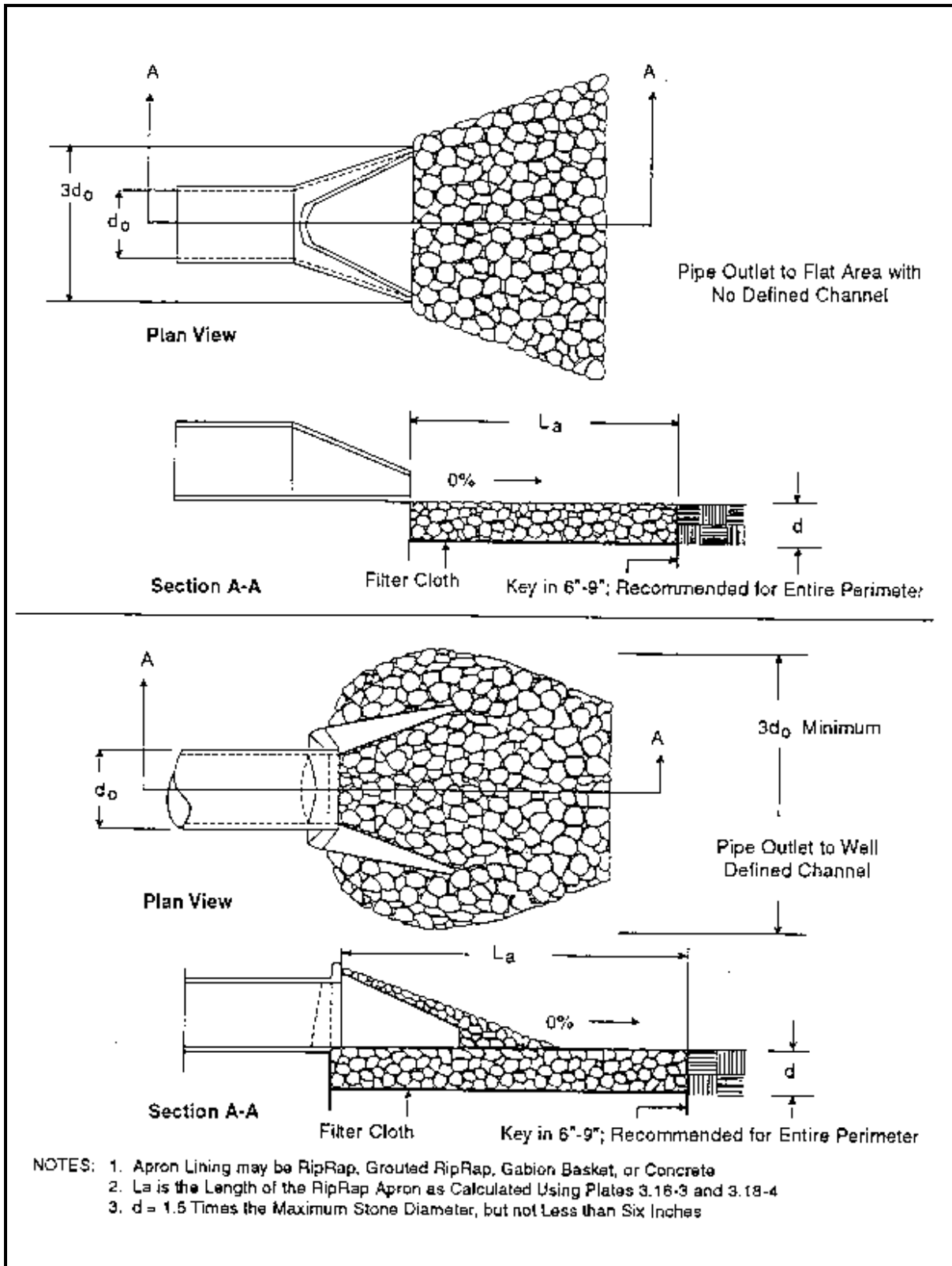

Figure 6.14c. Pipe Outlet Conditions

Source: Virginia DSWC

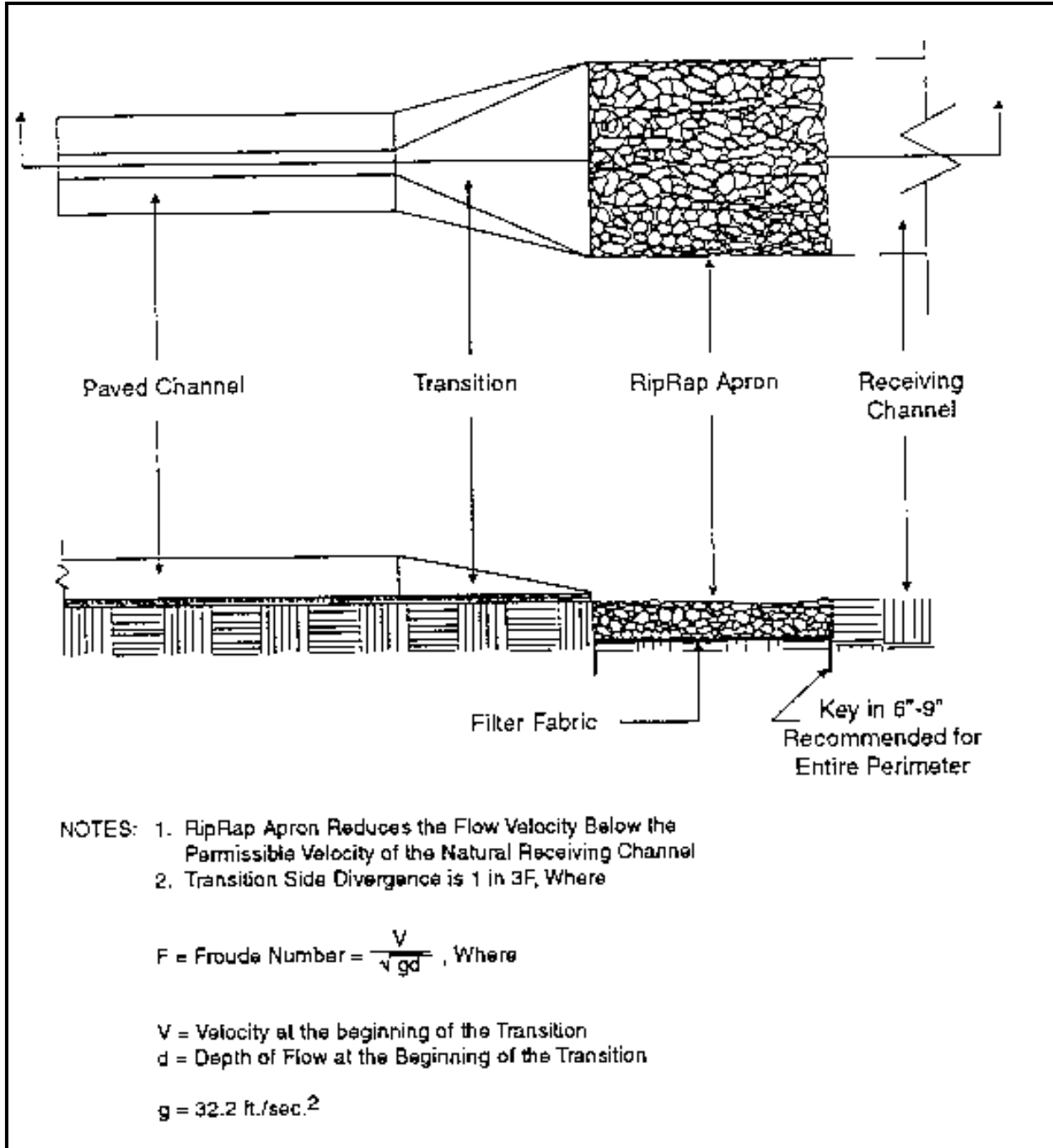

Figure 6.14d. Paved Channel Outlet

Source: Virginia DSWC

6.15 Riprap

Definition

A permanent, erosion-resistant ground cover of large, loose, angular stone.

Purposes

1. To protect the soil surface from the erosive forces of concentrated runoff.
2. To slow the velocity of concentrated runoff while enhancing the potential for infiltration (see **Figure 6.15a**).
3. To stabilize slopes with seepage problems and/or noncohesive soils (see **Figure 6.15b**).



Conditions Where Practice Applies

The practice is used for soil–water interfaces where soil conditions, water turbulence and velocity, expected vegetative cover, etc., are such that the soil may erode under the design flow conditions. Riprap may be used, as appropriate, at storm drain outlets; on channel banks and/or bottoms, roadside ditches, and drop structures; at the toes of slopes, etc. (see **Figure 6.15c**).

Construction Specifications

Subgrade Preparation

The subgrade for the riprap or filter blanket shall be prepared to the required lines and grades. Any fill required in the subgrade shall be compacted to a density approximating that of the surrounding undisturbed material. Brush, trees, stumps, and other objectionable material shall be removed.

Filter Blanket

The placement of the filter blanket should be done immediately after slope preparation. For granular filters, the stone should be spread in a uniform layer to the specified depth. Where more than one layer of filter material is used, the layers should be spread so that there is minimal mixing of the layers.

For plastic filter cloths, the cloth should be placed directly on the prepared slope. The edges of the sheets should overlap by at least 12 inches (30 cm). Anchor pins 15 inches (38 cm) long should be spaced every 3 feet (90 cm) along the overlap. The upper and lower ends of the cloth should be buried a minimum of 12 inches (30 cm) deep. Care should be taken not to damage the cloth when placing the riprap. If damage occurs, that sheet should be removed and replaced. For large stone 12 inches (30 cm) or greater, a 4 inch (10 cm) layer of gravel may be necessary to prevent damage to the cloth.

Stone Placement

The placement of riprap should immediately follow the placement of the filter. The riprap should be placed so that it produces a dense, well-graded mass of stone with a minimum of voids. The desired distribution of stones throughout the mass may be obtained by selective loading at the quarry, the controlled dumping of successive loads during final placing, or a combination of these methods. The riprap should be placed to its full thickness in one operation, not placed in layers. Stones should not be placed by dumping into chutes or similar methods that are likely to cause segregation of the various stone sizes. Care should be taken not to dislodge the underlying material when placing the stones.

The finished slope should be free of pockets of small stone or clusters of large stones. Hand placing may be necessary to achieve the required grades and a good distribution of stone sizes. The final thickness of the riprap blanket should be within plus or minus one-fourth of the specified thickness.

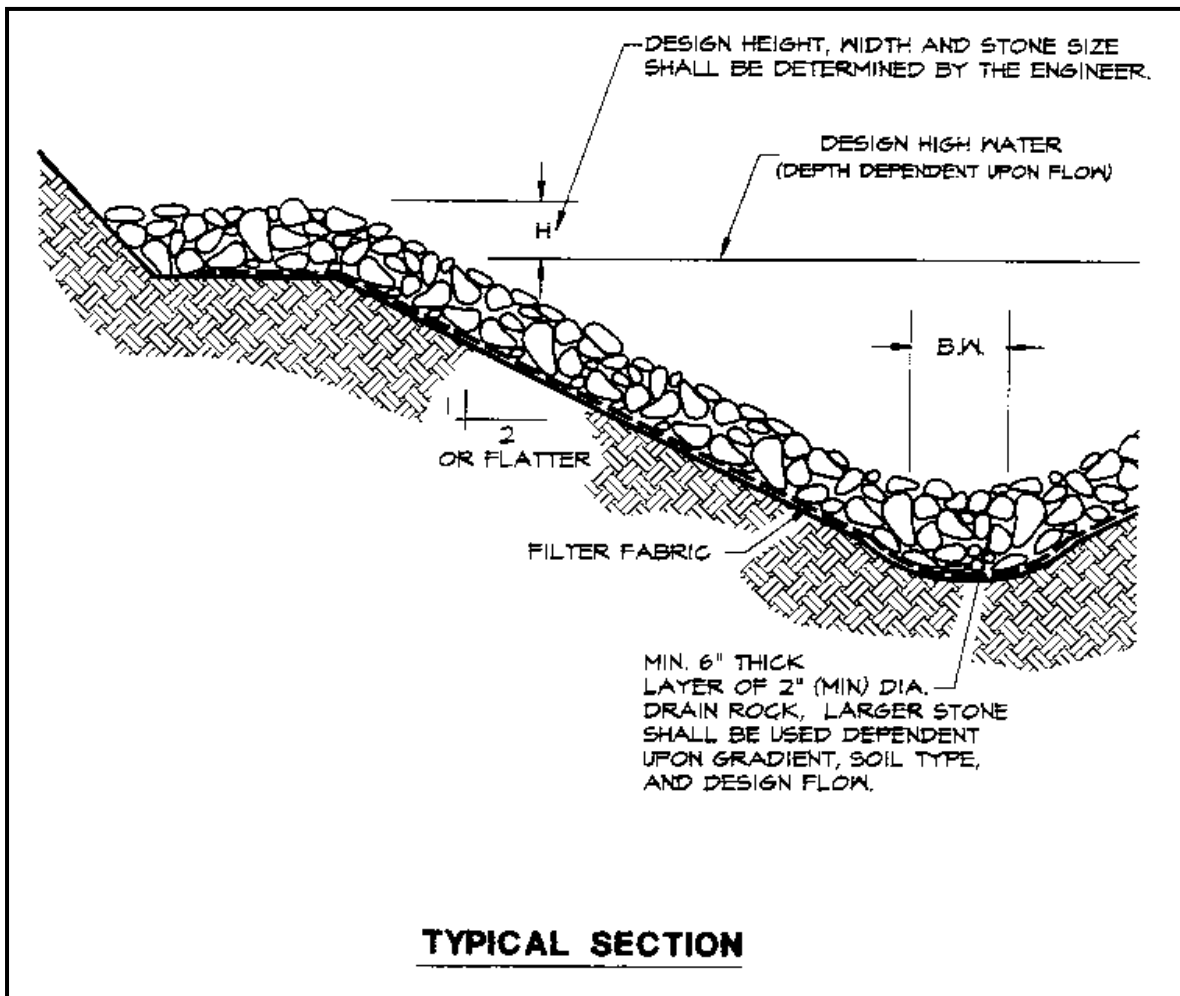

Figure 6.15a. Rock-Lined Channel

Source: Erosion Draw

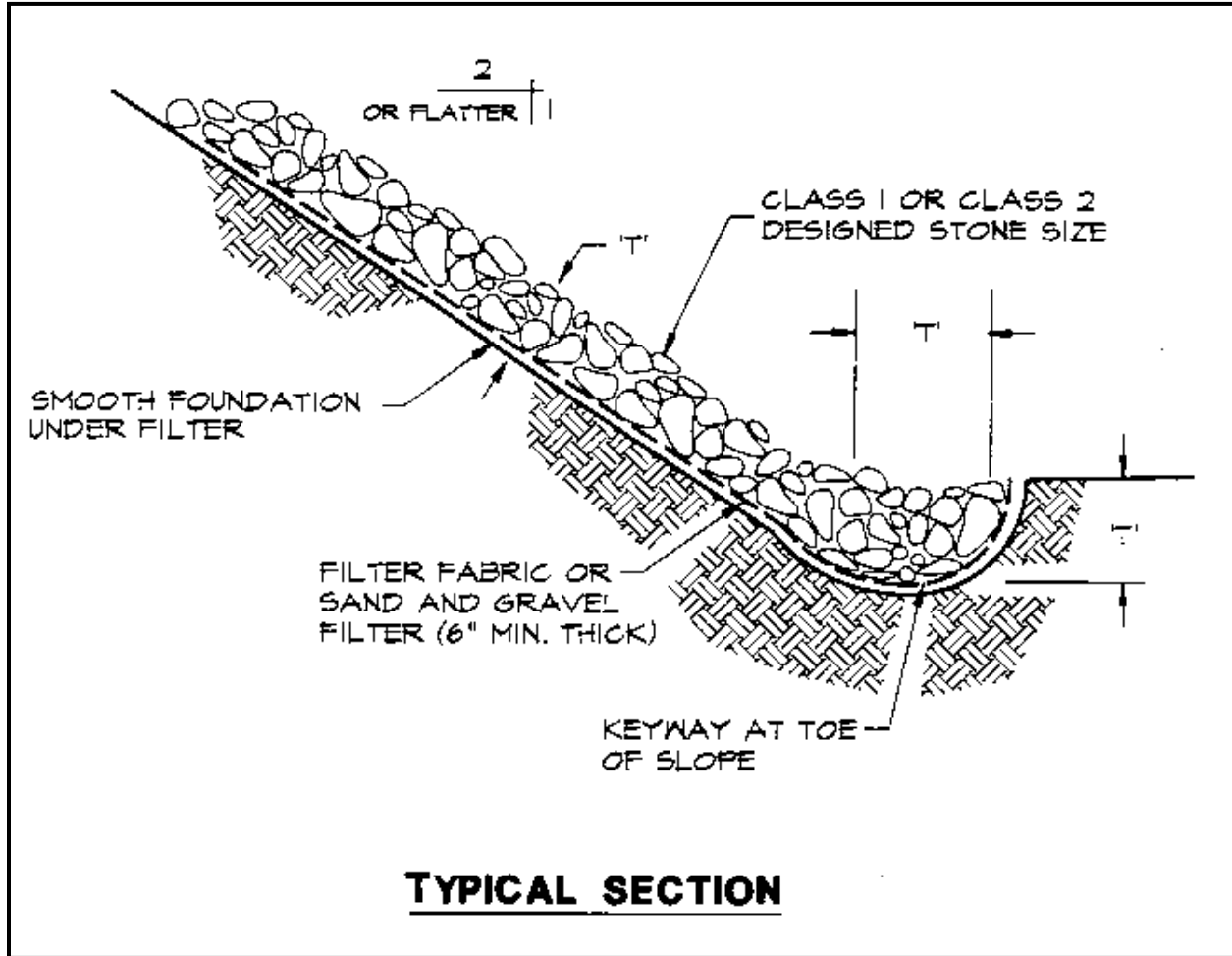

Figure 6.15b. Riprap Slope Protection

Source: Erosion Draw

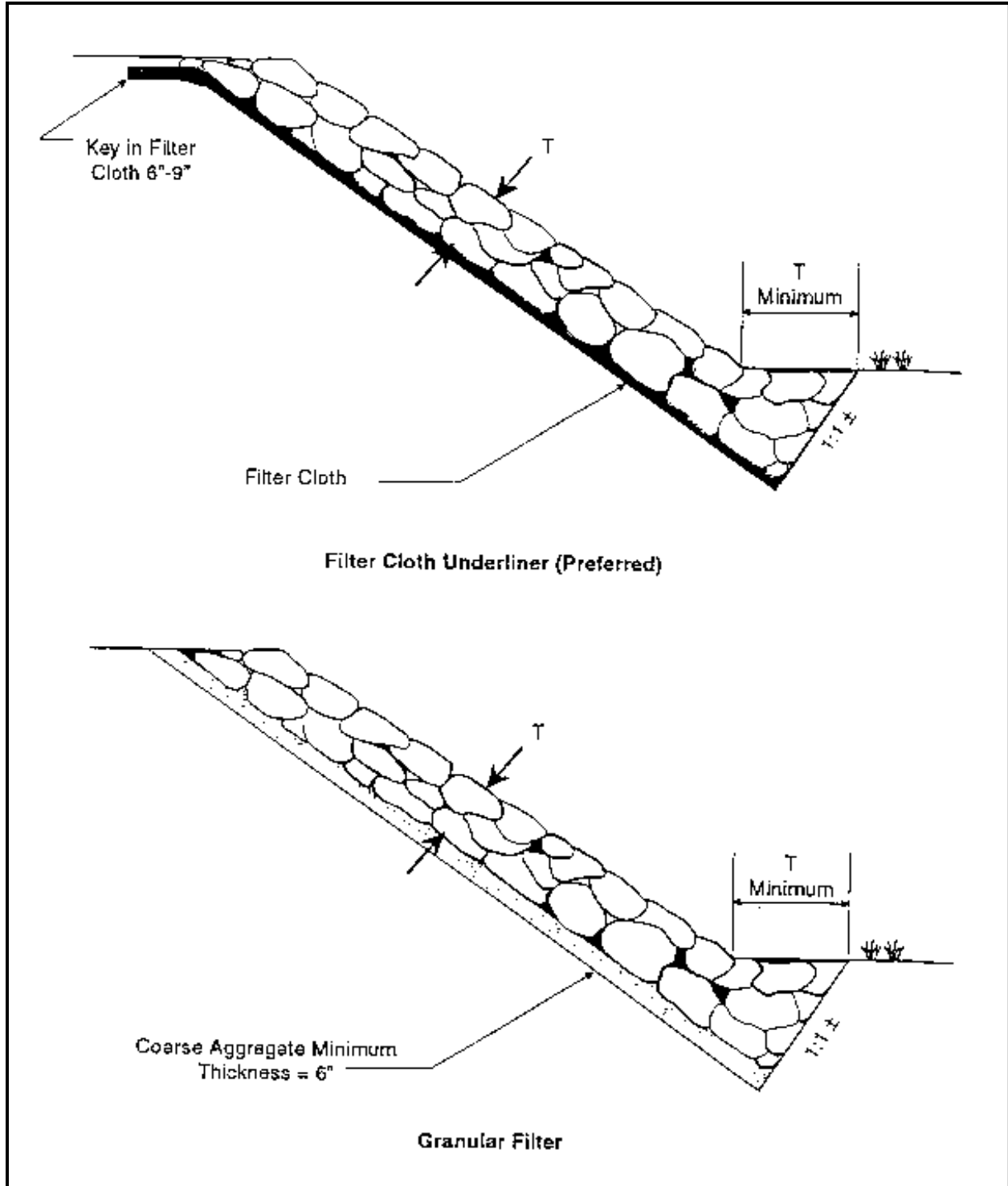

Figure 6.15c. Toe Requirements for Bank Stabilization

Source: Virginia DH&T

6.16 Grid Confinement System

Definition

A high-density polyethylene (HDPE) grid confinement system stabilizes slopes or stream banks and allows vegetation to establish itself. The geometry of the three-dimensional cells also increases load-bearing capacity (see **Figure 6.16a**).



Purpose

To prevent erosion from relatively steep slopes by the stabilization of the soil surface.

Conditions Where Practice Applies

1. Disturbed areas that require protection from erosive forces, but require the aesthetics of vegetation not provided by rock riprap or continuous concrete lining.
2. Sloping areas with intermittent traffic or other factors that make vegetation hard to establish or maintain (see **Figure 6.16b**).
3. Areas that require a firm surface for mowing with mechanical equipment.
4. Low-volume vehicle use areas, such as overflow parking, utility easements, unpaved roads, and driveways.
5. Grid confinement systems can be stacked to build earth-retaining walls (see **Figure 6.16c**).

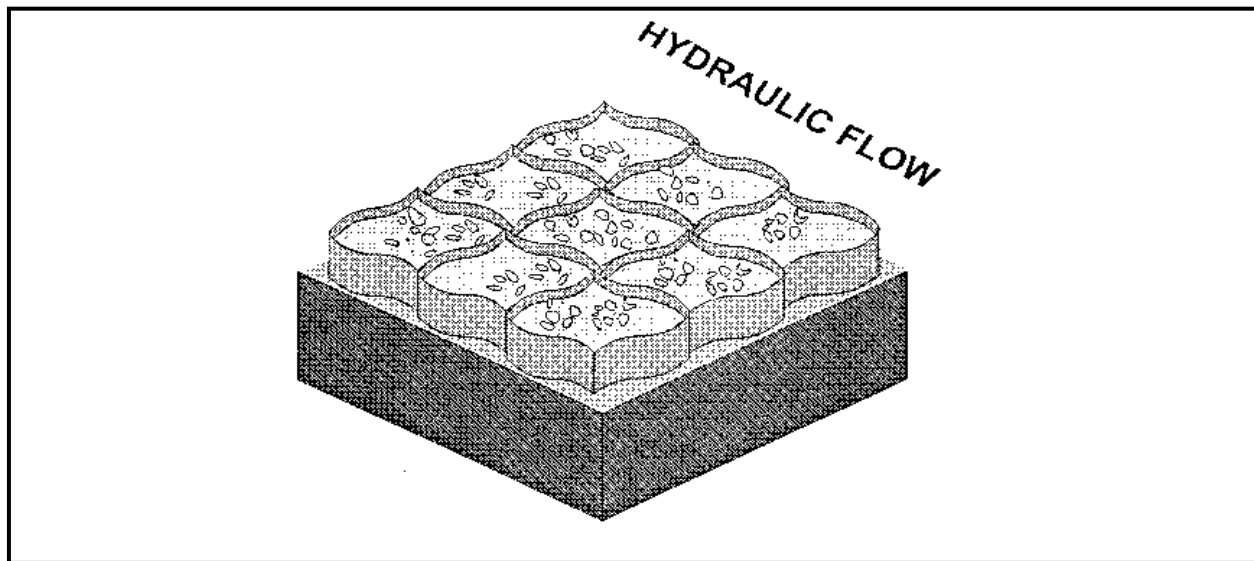

Figure 6.16a. **Grid Confinement System**

Source: NRCS

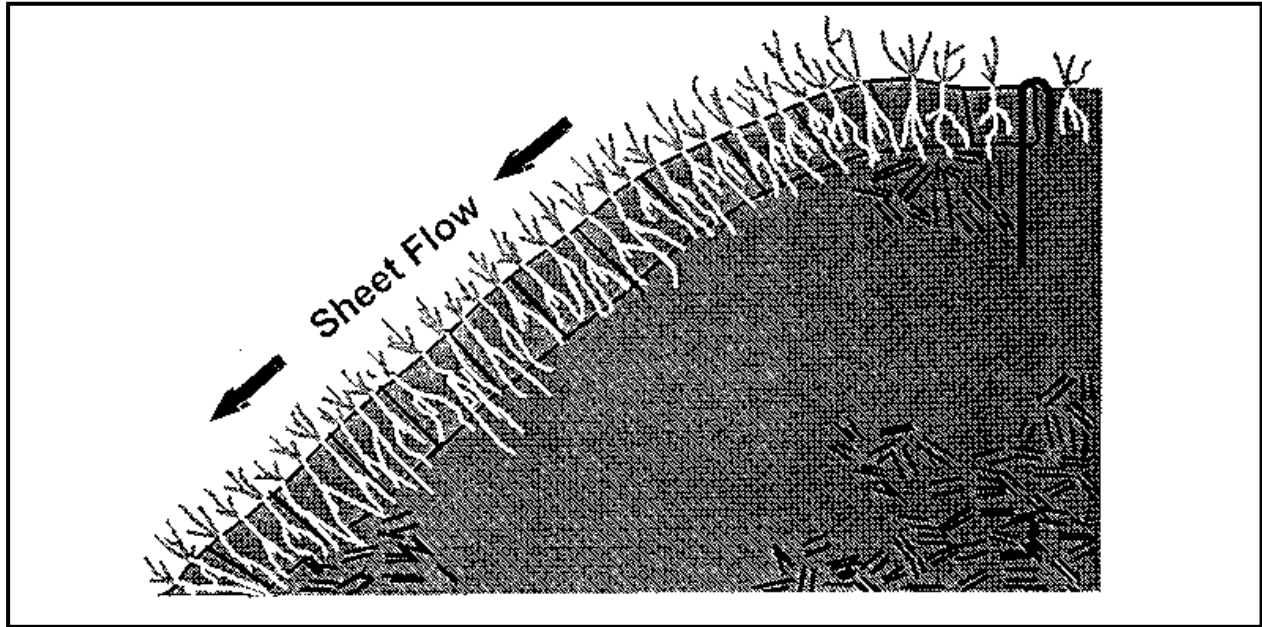

Figure 6.16b. Vegetative Protection

Source: NRCS

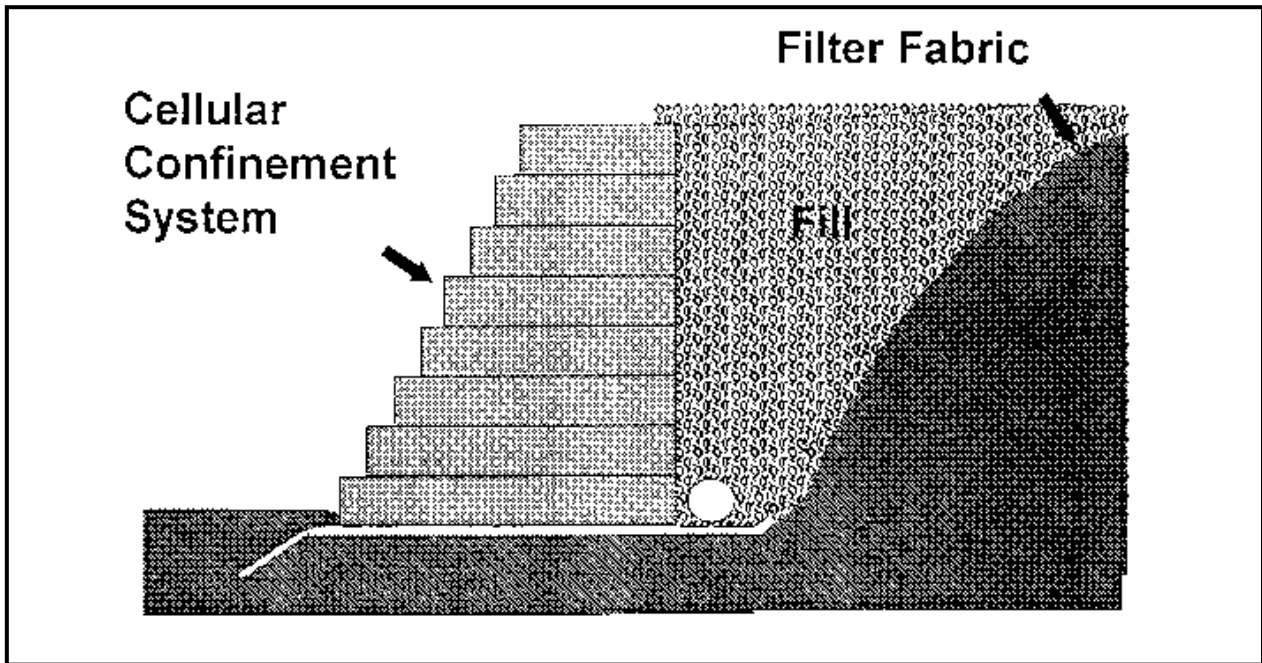

Figure 6.16c. Gravity Retaining Wall

Source: NRCS

Planning Considerations

Compared with cellular concrete block or rock riprap, grid confinement systems are a less expensive alternative erosion control practice that combines the benefits of vegetative and structural practices. A grid confinement system can be filled with locally available soils, small rock, or concrete. By stacking layers of grids, retaining wall structures can be created. **TEMPORARY SEEDING** or **PERMANENT SEEDING** (in **Chapter 7**) may be needed after installation to establish appropriate vegetative cover.

Design Criteria

No formal design is required.

Construction Specifications

Geotextile

Geotextile shall be placed prior to the placement of the grid confinement system. The proper filter fabric to be used should be determined using a sieve analysis of the soil being protected. After the analysis, a filter fabric is selected that will retain the soils being protected and have openings large enough to permit drainage and prevent clogging. The strength under tensile stress for the filter fabric should be at least one and one-half times the weight of the blocks. If no backfill material is to be used, the fabric should have good ultraviolet (UV) light stability. Filter fabric should be buried at least 12 inches (30 cm) at the upper end of the protected area to prevent undermining.

Placement

Prior to the placement of the filter fabric, the area to be affected should be prepared so there is a minimal disruption of the smooth plane of the slope. The grid confinement system shall be stretched according to the manufacturer's recommendation. The grid may be attached to a pre-constructed rack to aid in installation. The grid shall be staked, at a minimum, at least every third cell across the top, bottom, and center of each grid unit, if the unit dimension exceeds 3 feet (90 cm). If the unit's length is less than 3 feet (90 cm), stakes are required at the top and bottom of the grid. Where grids are laid adjacent to each other, the cells shall be locked together using hog rings or an equivalent locking system.

Backfill and Vegetation

Open grids will be backfilled with gravel, crushed stone, or soil. Vegetation provides additional stability at the area above the protective lining by consolidating soil. The area may need to be seeded to accelerate the establishment of vegetation. Seed may be premixed with the fill material to prevent the seed from washing out before germination.

The equipment placing the material shall not travel on top of the confinement grid until cells are filled in. As part of the grid is filled, the equipment may drive on that portion, subject to the manufacturer's recommendations. If the fill is a graded mixture, it shall be placed in a manner to avoid segregation.

6.17 Cellular Concrete Block

Definition

Precast perforated concrete blocks that stabilize slopes or stream banks, but also allow vegetation to establish itself through openings in the block.



Purposes

1. *To prevent relatively steep slopes from eroding, through the stabilization of the soil surface (see **Figure 6.17a**).*
2. *To protect the banks of streams, lakes, estuaries, and excavated channels against scour (see **Figure 6.17b**).*

Conditions Where Practice Applies

1. *Disturbed areas that need protection from erosive forces, but that require the aesthetics of vegetation not provided by rock riprap or continuous concrete lining.*
2. *Sloping areas with intermittent traffic or other factors that make vegetation hard to establish or maintain.*
3. *Areas that require a firm surface for mowing with mechanical equipment.*
4. *Land–water interfaces such as shorelines, channel linings, bridge abutments, spillways, boat ramps, and low-water stream crossings.*

Planning Considerations

Cellular concrete block is an expensive alternative erosion control practice that combines the benefits of both vegetative and structural practices. Blocks may be of the interlocking or non-locking type and may be interconnected with flexible cable. Interconnected blocks can be swung into place for ease of underwater installation. These blocks can be used as a temporary installation and later removed and reused.

It may be necessary after installation to provide **TEMPORARY SEEDING** or **PERMANENT SEEDING** (in **Chapter 7**) to establish appropriate vegetative cover.

Design Criteria

Design standards are currently under development by the IECA, working with ASTM.

Construction Specifications

Subgrade Preparation

The slope should be graded to a smooth plane surface to ensure that close contact is achieved between the slope face and the geotextile, and between the geotextile and the bottom of the articulated concrete blocks. All deformities, roots, grade stakes, and stones projecting from the slope face must be removed, and the slope must be

regraded. Holes, "pockmarks," slope board teeth marks, footprints, grooves, depressions, or other localized voids should also be removed, filled, and compacted. The slope and slope face should be uniformly compacted to 95% standard proctor density.

To ensure a uniform channel cross-section, it is suggested that a grading template be constructed and "dragged" down the channel in front of the shovel crew. The anchor trench at the top of the slope should be uniformly graded to ensure close contact between all articulated blocks and the underlying grade at the transition between the embankment crest and the slope face. Immediately prior to placing the filter fabric and articulated block, the design engineer should inspect and approve the prepared area.

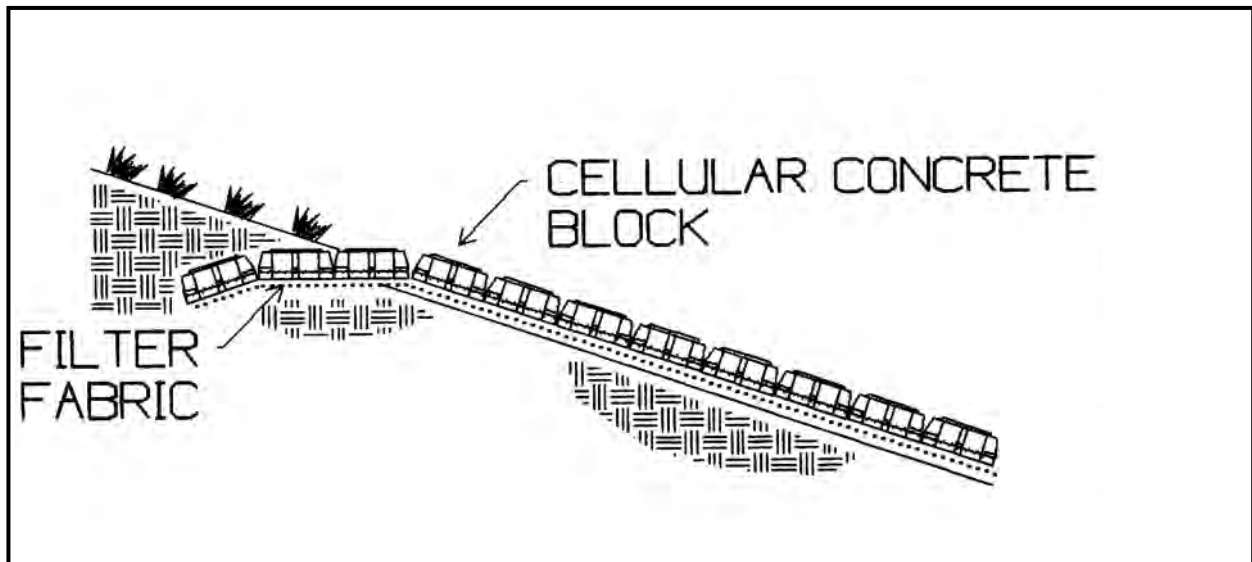

Figure 6.17a. Slope Protection

Source: R.H. Moore & Associates

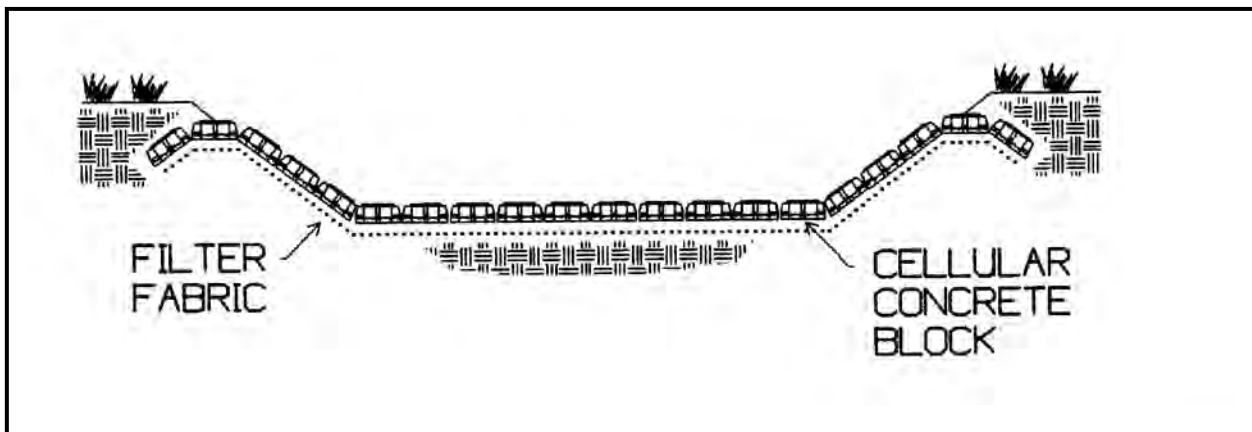

Figure 6.17b. Channel Bottom Protection

Source: R.H. Moore & Associates

Placement of Geotextile

The geotextile should be placed directly on the prepared area, in close contact with the subgrade, and free of folds or wrinkles. The geotextile should not be walked on or disturbed if it results in loss of close contact between the articulated block and the geotextile, or between the geotextile and the subgrade. The geotextile should be placed so that the upstream strip of fabric overlaps the downstream strip. The longitudinal and traverse joints should overlap at least 3 feet (1 m). The geotextile should extend at least 1 foot (30 cm) beyond the top and bottom of the revetment. If articulated blocks are assembled and placed as large mattresses, the edge of the geotextile should not occur in the same location as a space between the articulated block mattresses.

Placement of Articulated Block

The articulated blocks should be placed on the geotextile to produce a smooth plane surface in close contact with the geotextile. No individual block within the plane of placed articulated blocks should protrude more than the design tolerance, typically 0.5 inches (12 mm). To ensure that the articulated blocks are flush and develop close contact with the subgrade, it is suggested that the blocks be "seated in" with a roller or "stepped on" to produce a flush surface.

If assembled and placed as large mattresses, the articulated mats are typically attached to a spreader bar to aid in lifting and placing the mats in their proper position with a crane. The mats should be placed side by side and/or end to end, so that they abut each other. Mat seams or openings between mats greater than 2 inches (5 cm) should be filled with grout.

Whether placed by hand or in large mattresses, distinct grade changes should be accommodated with a transition curve of not less than 4 feet (1.3 m). However, if a discontinuous surface exists in the direction of flow, a grout seam at the grade change location should be provided to produce a continuous, smooth flow surface.

Installation Details

The articulated concrete block system should extend horizontally at the top of an embankment side slope at least 2 feet (0.6 m) into the embankment before terminating. The revetment should be terminated into an anchor trench at least 2 feet (0.6 m) deep. The trench should be immediately backfilled, compacted, and protected from erosion that could cause undermining of the system. The top of the anchor trench should remain flush with the top surface of the block system. When flow transition occurs, as in the case of flumes or drop structures, the articulated blocks should extend into the zone of subcritical flow before terminating in an anchor trench.

The termination at the toe of the protected embankment could either be (1) extended outward as an apron a distance of 1.5 times the maximum expected depth of scour, (2) buried to a depth of 1.5 times the maximum depth of scour, or (3) buried with large rocks or other suitable erosion-resistant backfill. When the articulated block system is to be buried, the blocks should continue into the toe trench along the same grade as the slope being protected. Side termination is performed by burying the articulated block into an anchor trench at least 2 feet (0.6 m) deep and backfilling with a nonerodible material to the top surface or the adjacent blocks.

Grouting

When placing blocks at sharp bends, pilings, pipe outlets, slope intersections, and other irregular areas, individual blocks should be cut to fill the area. Concrete grout should be placed in the area where blocks have been cut (see **Figure 6.17c**). Grout should also be placed in any seams or joints greater than 2 inches (5 cm) wide.

Backfill and Vegetation

Void spaces in the articulated concrete block system may be filled with gravel or crushed stone in areas below the waterline and with soil in areas above the waterline. Do not overfill voids with soil, as the best results are obtained when the soil level is kept $\frac{1}{2}$ to $\frac{3}{4}$ inch (12 to 18 mm) below the top of the blocks. Typically, 1 cubic yard of material is needed for every 200 square feet of area ($1 \text{ m}^3/24 \text{ m}^2$).

Vegetation provides additional stability to the area above the protective lining by consolidating the soil. Seeding may be needed to accelerate the establishment of vegetation. Seed should be premixed with the fill to prevent the seed from washing out before the vegetation is established. Hydroseeding may also be used (see **Figure 6.17d**).

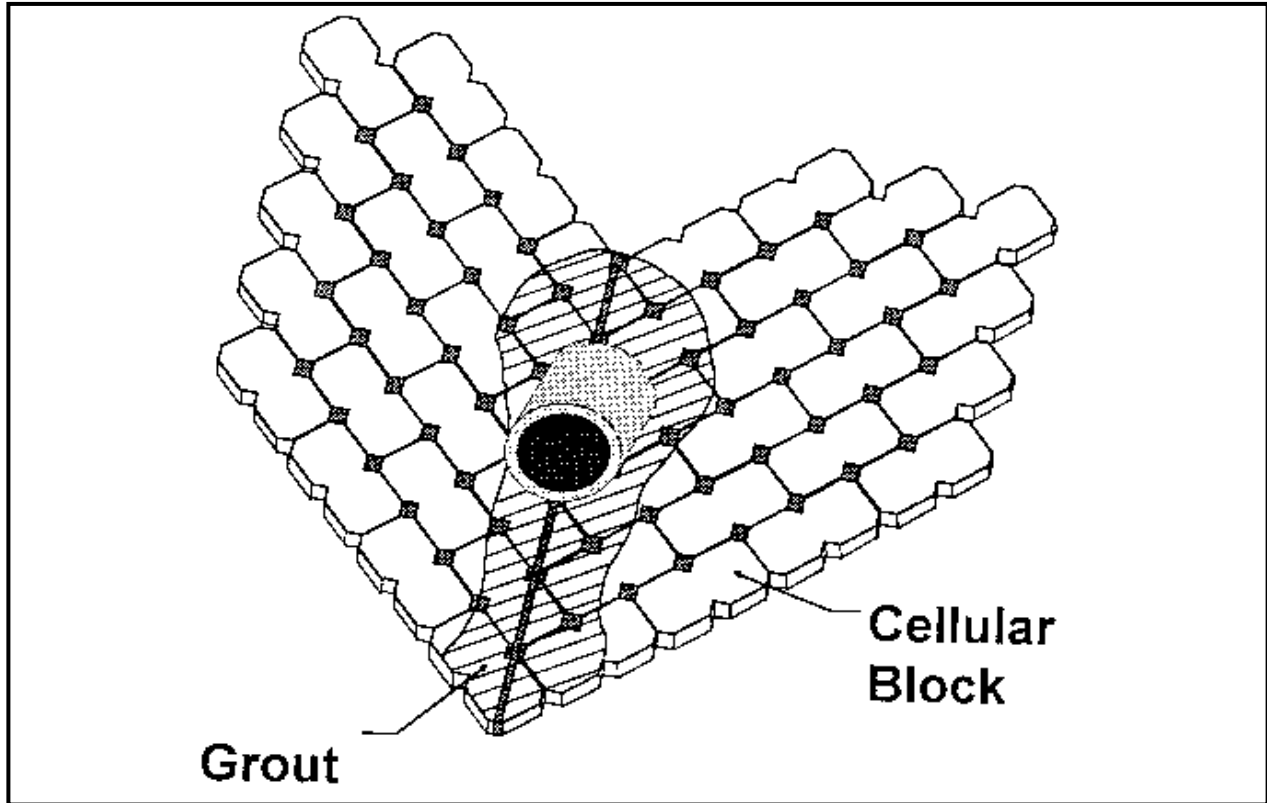

Figure 6.17c. Grout Illustration

Source: NRCS

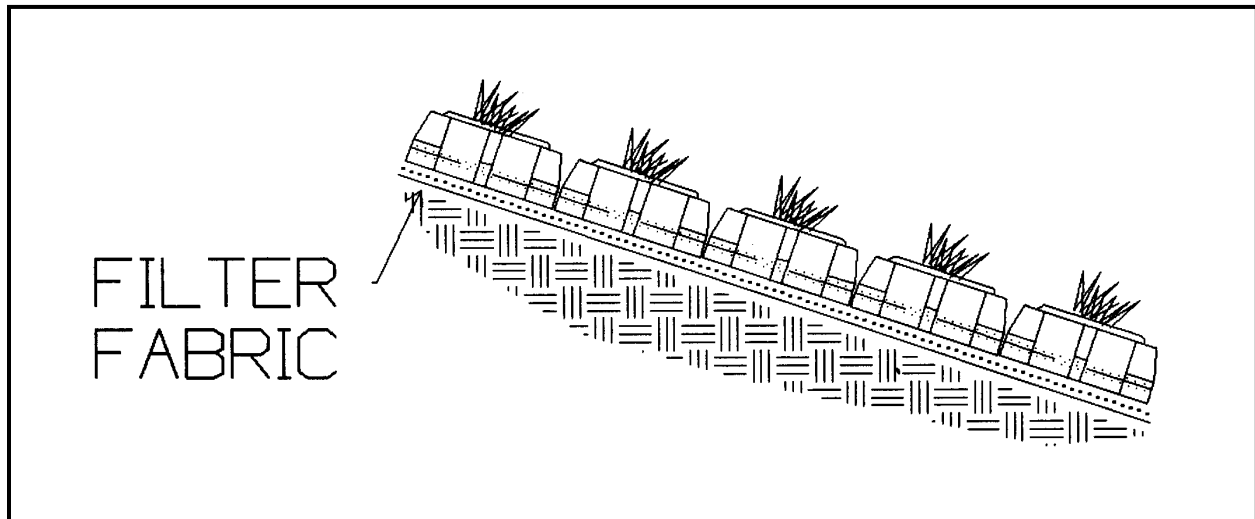

Figure 6.17d. Revegetation

Source: NRCS

6.18 Maintenance

General

Maintenance is of primary importance if stormwater management systems are to continue to function as originally designed. A local government, a designated group such as a homeowners' association, or an individual must accept the responsibility for maintaining the structures and the impoundment area. A set of "as-built" plans should be prepared for and maintained by the responsible entity. A specific maintenance plan should be formulated outlining the schedule and scope of maintenance operations. It should be stressed that good records should be kept on all maintenance operations to help plan future work and identify facilities requiring attention.

Inspections

All stormwater systems should be routinely inspected to ensure that they are functioning properly. Major inspections should be conducted semiannually, and brief inspections should always be conducted following storms with over 1 inch (25 mm) of rainfall. Systems that incorporate infiltration are especially critical, since poor maintenance practices can soon render them inefficient. It is also advisable to ensure that vegetation (sod) is growing well and that all construction is according to approved design.

Safety

All permanent impoundments and structures should be inspected periodically by a Florida registered professional engineer to ensure that they remain structurally sound and mechanically efficient. An annual safety inspection is recommended where the potential for downstream damage and loss of life due to impoundment failure is high. Look for signs of burrowing animals, especially on or near embankments. All structures should also be inspected for scour, erosion, settlement, and structural failure following major storms.

Many jurisdictions require fences around impoundments with side slopes of 3:1 or steeper. Fencing, gates, and locks should be inspected quarterly, and a list of key holders should be kept.

Public Health

Precautions should be taken to minimize the production of fast-breeding insects in and around ponded areas. Possible control measures include controlling the growth of vegetation at shorelines, varying the water depth every few days, and stocking the pond with mosquito-eating fish such as *Gambusia*.

Maintaining Retention Systems

Stormwater Retention Basins

Routine Maintenance

The cleanout frequency of infiltration basins depends on a number of factors, including whether they are vegetated or nonvegetated, whether pretreatment BMPs are used, and their storage capacity, infiltration characteristics, volume of inflow, and amount and type

of sediment load. Infiltration basins should be thoroughly inspected at least semiannually. Sedimentation basins and traps may require more frequent inspections and cleanout. These structures should be cleaned out when sediment levels reduce storage volume by 10%. An elevation mark (also known as a tattletale) should be located inside the basin.

Nonvegetated basins can be scarified annually following the removal of all accumulated sediments. Rotary tillers or disc harrows with light tractors are recommended for maintaining retention basins. The use of heavy equipment should be discouraged to prevent excessive compaction of surface soils. The basin floor should be left level and smooth after the tilling operation to ease the future removal of sediment and minimize the amount of material to be removed during future cleaning operations. A leveling drag towed behind the equipment on the last pass will accomplish this. However, this operation can be eliminated or minimized by the establishment of grass cover on the basin floor and slopes. The roots of vegetation help maintain soil permeability.

The BMP treatment train, especially sediment traps or forebays, can be used to reduce the maintenance of infiltration basins by settling out suspended solids, or removing oil and grease before the water is released into the infiltration basin.

Infiltration basins should never be used for sediment control during the construction process. In situations with heavy sediment loads, chemical flocculants can also be used to speed up settlement in pretreatment sediment traps or forebay ponds. Flocculants should be added to the runoff water in the settlement pond inlet pipe or culvert, where turbulence will ensure more thorough mixing. After suspended matter has flocculated and settled in the settling pond, the water may then be released into the infiltration basin for disposal.

Algae or bacterial growth can also inhibit infiltration. To avoid this problem, make certain that the basin dries out between storms, especially during the wet summer months.

Exfiltration Trenches

Preventive maintenance is vital to the continued effectiveness of all infiltration BMPs, but especially for exfiltration systems. Pretreatment measures to filter out suspended materials that might clog the trench are necessary, because once void areas become clogged, maintenance entails a complete replacement of the filter material. The use of filter fabrics over the surface of an infiltration trench that is open to the surface for runoff can be most effective in keeping objectionable material from entering the system. Of course, periodic cleaning or replacement of clogged filter fabric will be necessary.

Routine Maintenance

The routine maintenance requirements of trenches are not great. However, getting property owners to actually perform them may be very difficult. Trenches are smaller and more inconspicuous than most other BMPs, and when located underground, they may not be visible or accessible. As a result, residents or homeowners' associations are not likely to exhibit as much concern over trench maintenance as they might for more visible BMPs, such as detention ponds.

For these reasons, a public sector commitment to regularly inspect privately owned trenches is a necessity. Property owners and associations will need to be educated

about the function and maintenance requirements of the trench. A legally binding maintenance agreement should be included with the property deed that clearly describes maintenance tasks and schedules. Further, the agreement should grant access for regular inspections, and enable the public sector to perform maintenance (and bill the owners) if the trench has been neglected. Some of the normal maintenance tasks for trenches are detailed below.

Inspection

The trench should be inspected several times in the first year of operation and at least semiannually thereafter. The inspections should be conducted after large storms to check for surface ponding that might indicate local or widespread clogging. Water levels in the observation well should be recorded over several days to check trench drainage. Surface trenches can be inspected by hand by digging with a trowel down to the first layer of filter fabric, usually located 1 foot (30 cm) below the surface.

Buffer Maintenance

The condition of the grass buffer strips used in conjunction with trenches should be inspected regularly (see **SODDING** in **Chapter 7** for further information on buffer maintenance).

Sediment Removal

The pretreatment inlets of underground trenches should be checked periodically and cleaned out when sediment depletes more than 10% of the available capacity. This can be done manually or by a vacuum pump. Inlet and outlet pipes should be checked for clogging and vandalism.

Non-routine Maintenance

The primary non-routine maintenance task is to rehabilitate the trench after it becomes clogged. There is no reliable estimate of how long trenches will function before they clog. However, the longevity of trenches may be on the order of 10 years at best.

Clogging in surface trenches is most likely to occur near the top of the trench, between the upper layer of stone and the protective layer of filter fabric. Surface clogging can be relieved by carefully removing the top layer of stone, removing the clogged filter fabric, installing new filter fabric, and cleaning or replacing the top stone layer. The costs for rehabilitating a surface trench will usually not exceed 20% of the initial construction cost, adjusted for inflation.

The clogging of underground trenches is a much more serious problem, as it is likely to occur at the bottom of the trench, at the filter fabric/soil interface. The rehabilitation of an underground trench requires removing the pavement or the topsoil/vegetation layer, the protective plastic layer, the stone aggregate, and the bottom filter fabric layer. Then, the subsoil layer must be tilled to promote better infiltration, and each layer must be replaced. If pavement or concrete constitute the surface layer (instead of topsoil/grass), the rehabilitation effort becomes more difficult and costly.

Total Maintenance Costs

No reliable data are currently available to assess maintenance costs for trenches. Routine maintenance costs are probably higher for surface trenches than underground trenches, primarily due to the frequency. As noted earlier, the opposite is probably true

for non-routine maintenance tasks. It is reasonable to assume that the cost of rehabilitating an underground trench is roughly equivalent to the initial construction cost. Surface trench rehabilitation should be approximately 20% of the initial construction cost; however, there are reasons to expect that the clogging of surface trenches may occur more frequently.

If it is assumed that surface and underground trenches will need rehabilitation every 5 to 15 years, respectively, an annual maintenance set-aside of 5% to 10% (surface trenches) and 10% to 15% (underground trenches) of the initial construction cost may be needed to cover routine/non-routine maintenance expenditures. It must be emphasized that these estimates are highly uncertain. Until more local experience is obtained, the issue of trench maintenance costs remains largely speculative.

Porous Pavement

Routine Maintenance

Routine maintenance involves the removal of debris that is too coarse to be washed through the pavement system. Vacuuming pavements is required to remove particulates that are fine enough to be carried into the pavement but too large to pass through, thus clogging the void space. Porous pavements require no more repair maintenance than conventional pavements, and so maintenance problems can generally be reduced to better "housekeeping" practices on the part of area residents and more efficient street-cleaning procedures in municipalities.

To preserve the high filtration rate of the pervious paving, routine inspection and maintenance are required. The surface should be routinely visually checked (preferably after a prolonged storm event) for evidence of debris, ponding of water, clogging of pores, and other damage. Any debris should be immediately removed. Monthly cleaning with a vacuum street sweeper should be performed to thoroughly clean the surface.

Cleaning

It has long been recognized that the maintenance and cleaning of porous pavements to prevent or alleviate clogging is a factor in the use of such pavements. Various methods have been used to clean sections of porous pavement that have become clogged. However, no satisfactory method has been found for cleaning fully clogged pavements, and only a superficially clogged section showing a water penetration rate of 0.1 inch (2.5 mm) per second compared with a normal water penetration of 0.38 inch (10 mm) per second can be restored to normal operation. The best method for cleaning is brush and vacuum sweeping, followed by high-pressure water washing of the pavement.

In Maryland, it was determined that vacuum cleaning alone, once the pavement is clogged, is largely ineffective. The oils bind dirt, and only an abrading and washing technique is effective in its removal. Clogging to a depth of 0.5 inch (13 mm) is sufficient to prevent water penetration.

If, during visual inspection, any ponding or clogging is noticed, the following program should be followed to correct the problem. First, a street sweeper with a vacuum should be used. If ponding persists, the pavement can be steam cleaned with a biodegradable substance and then vacuumed. If the clogging is at a depth greater than ½ inch (13 mm), holes that are ¼ inch (6.5 mm) in diameter and 1 foot (30 cm) on center can be

drilled through concrete pavement. Hand-held drills or truck-mounted drill rigs may be used. All drilling debris should be vacuumed from the pavement.

Replacing Clogged Pavement

Once a large area of porous pavement is fully clogged and cannot be adequately cleaned, the paving must be removed to a depth where the clogging is not evident and new porous paving filled in. In extreme cases, the affected area must be removed and new topping put down. Since these materials are relatively new, obtaining a patching mix suitable to match the installed pavement may be difficult. Available patching material is usually dense graded at present. If the sub-base becomes clogged, the pavement must also be saw cut and removed. Six to 12 inches (15 to 30 cm) of the sub-base usually needs to be replaced with clean sand, and then proof rolled. Pervious paving then needs to be filled in.

Concrete Grid and Modular Pavement

Where turf is incorporated into these installations, normal turf maintenance—watering, fertilizing, and mowing—is necessary. Mowing is seldom required in high-traffic areas. It is documented that the hard surfaces in these installations require very little maintenance. However, fertilizers, pesticides, and other chemicals may have adverse effects on concrete products. The use of such chemicals should be restricted as much as possible.

Grassed Waterways and Swales

Timely maintenance is important to keep a swale in good working condition. Fertilizing and mowing should be done frequently enough to keep the vegetation in vigorous condition. The cut vegetation should be removed to prevent the decaying organic litter from adding pollutants to the discharge from the swale.

Vehicular traffic should be excluded from the swale. Following heavy rainfall, always inspect the area for failures and carry out necessary repairs, replacements, or reseeding during the planting season. If complete reseeding is necessary, apply half the original recommended rate of fertilizer with a full rate of seed.

Many residents find swales to be convenient sites for the disposal of leaf litter, grass clippings, and other types of refuse. The proper operation of these facilities from both a hydraulic and treatment standpoint depends on the integrity and knowledge of the residents whom the system serves. The actions of a few careless individuals can cause an outlet to become plugged with debris, leading to the delivery of abnormally high levels of organic material to downstream waters, and sometimes the flooding of a neighbor's property. Public education programs should be undertaken, as necessary, to ensure that swales are not used as trash disposal areas. FDEP has published a pamphlet entitled *Save the Swales* to facilitate education (available: <http://www.dep.state.fl.us/water/nonpoint/docs/nonpoint/sts.pdf>).

Special Operations and Maintenance Conditions for Karst-Sensitive Areas

In areas of active sinkhole activity, a site inspection should be performed by field personnel when the retention basin is excavated to final grade. The objective is to visually inspect for exposed limerock or solution pipes. To mitigate the potential for

direct connections from onsite infiltration basins to ground water, the following recommendations are provided:

1. *Stormwater swales and retention basins should be monitored visually following significant storm events. If open solutions or pipes and/or sinkhole-like depressions are observed, this information should be relayed to permitting authorities, and appropriate corrective action should be taken.*
2. *Where small, shallow depressions are noted, these may be filled to pre-existing grade with clayey sand materials, graded, and vegetated.*
3. *When and if chimney-type solution pipes are exposed in a retention basin, these may be plugged in accordance with acceptable water well plugging and abandonment procedures. Where these features are small in diameter and of a limited vertical depth, the bridging of the pipe with indigenous limestone boulders is recommended. Once the bridge is in place, the pipe may be filled with clay and/or clayey sand back to the land surface and then vegetated.*
4. *Remedial plugging activities should employ methodologies acceptable to the applicable regulatory agency.*

Maintaining Detention Systems

Stormwater Detention Basins

The maintenance of sediment and debris basins is extremely important. Plans should include provisions for sediment removal when a certain storage elevation is reached. Debris removal in detention basins can be achieved through the use of trash racks or other screening devices. Debris should be removed from the basin following each storm.

Sediment

Sediment deposition should be continually monitored in the basin. The maintenance plan should specify an elevation at which the sediment should be removed. This elevation mark or tattletale should be located inside the basin. The mark should be set at no more than 25% of capacity; however, 10% is preferred.

Owners, operators, and maintenance authorities should be aware that significant concentrations of heavy metals (e.g., lead, zinc, and cadmium), as well as some organics such as pesticides, are expected to accumulate at the bottom of these treatment facilities. Sediment should be tested using Extraction Procedure (EP) Toxicity, especially near points of inflow, to determine the leaching potential and level of accumulation of hazardous material before disposal via land spreading or filling is prescribed.

Underdrains and Filters

Like all stormwater BMPs, a properly designed and constructed underdrain filter system requires maintenance to keep it operating. The underdrains should be inspected, especially after heavy rains, to see if they are working and if maintenance is required. Pore spaces in stormwater filters are expected to seal with time once the filters begin

operating. The duration of a filter's effectiveness before hydraulic capacity is reduced to the point that drawdown requirements can no longer be met depends on a number of factors, including the initial permeability of the filter material used, the degree of pretreatment (sedimentation) before stormwater enters the filtration facility, and the nature of the pollutants being removed. Common causes of subsurface filter system failures include the following:

1. *Underdrains installed with insufficient capacity.*
2. *Underdrains that are located too shallowly and the lack of auxiliary structures necessary for the installation.*
3. *Underdrains of insufficient strength or lacking in other qualities necessary for the installation.*
4. *Poor construction, resulting in inadequacies such as the poor connection of joints and fittings, improper bedding, poor grade and alignment, and improper backfilling.*
5. *Failure due to mineral deposits such as iron oxide. These deposits do not seriously affect the operation of the drain unless the perforations or joints become sealed. Usually, indications of deposits may be observed at the outlets, junction boxes, and inspection holes.*

Surface Maintenance

Vegetated basins can be mowed and maintained in accordance with **Chapter 7**. The surface layers of unvegetated basins may need to be disced or scraped following heavy storm events that carry heavy sediment loads. Preliminary indications show that these systems can often function for up to a year with only minor maintenance.

Filter Maintenance

Coarse-grained filter systems may require the complete replacement of the filter media to restore their function following clogging, since pollutants penetrate farther into these systems than in more fine-grained filters. Most of the particulates are trapped in the first 2 or 3 inches (5 to 8 cm) of the fine-grained filter, while suspended substances can penetrate up to a foot (30 cm) or more into the coarse-grained filter.

Semiannual restoration efforts are likely to involve the complete removal and cleaning and/or replacement of the top 12 inches (30 cm) or more of the filter material. While major maintenance of this type may not have to be done frequently, when it is required, the operation involves a significant amount of labor and material. Heavy machinery may be needed if the facility is large, and therefore care is needed to prevent damage to the underdrain pipes. There may be some problems associated with the ability of these more coarse-grained, evenly graded materials to support the machinery needed to perform maintenance activities, such as scraping, without getting equipment stuck and/or damaging the filter bed.

Pipe Network Maintenance

The roots of nearby trees and shrubs will penetrate and clog perforated pipe, if they are near enough. If an underdrain system is not functioning and the outlet is open, the lines should be checked near trees. Obstructions caused by roots can be cleared by a Roto-Rooter-type machine; however, this service will be required several times per year until

the source of root penetration is eliminated. High-pressure hydraulic nozzles have been successfully used to clean underdrain filter systems in Florida that show evidence of iron oxide.

NOTE: This segment does not constitute a product or service endorsement.

Another common maintenance problem with underdrains in Florida is getting landowners to keep the outlets free of silt and vegetation where they empty into open ditches. Sediment and fast-growing aquatic vegetation can cause the outlets to become entirely plugged within one year after installation; consequently, frequent inspections must be made.

Maintaining Conveyance Systems

Stormwater Conveyance Channels

Grass-Lined Channels

During the initial establishment, grass-lined channels should be repaired immediately and grass re-established if necessary. After grass has become established, the channel should be checked periodically to determine if the grass is staying in place. If the channel is to be mowed, it should be done in a manner that will not damage the grass.

Concrete-Lined Channels

Concrete-lined channels should be checked periodically to ensure that there is no undermining of the channel. Particular attention should be paid to the outlet of the channel. If scour is occurring at the outlet, appropriate energy dissipation measures shall be taken.

Sediment Deposition

If the channel is below a high sediment-producing area, sediment should be trapped before it enters the channel. If sediment is deposited in grass-lined channels, it should be removed promptly to prevent damage to the grass. Sediment deposited in riprap and concrete-lined channels should be removed when it reduces the capacity of the channel.

Diversions

Before final stabilization, a diversion should be inspected after every rainfall. Sediment shall be removed from the ditch line and repairs made as necessary. Seeded areas that fail to establish a vegetative cover shall be reseeded as necessary.

Flexible Channel Liners: Riprap, Gabions, Grid Confinement Systems, Cellular Blocks

Once a flexible channel liner installation has been completed, it should require very little maintenance. It should, however, be inspected periodically to determine if high flows have caused scour beneath the riprap or dislodged any of the stone or block. If repairs are needed, they should be carried out immediately. The repair should be stronger than the area that failed, and may therefore require grout, concrete, or larger stones.

Many of these systems are designed to incorporate vegetation. Desirable vegetation (turf) should be regularly mowed. Large weeds, shrubs, and trees should be controlled so that roots do not cause premature failure of the system.

Maintaining Stormwater Management Structures

Paved Flumes

Before the permanent stabilization of a slope, the structure should be inspected after each rainfall, and damage to the slope or paved flume should be repaired immediately. After the slope is stabilized, little maintenance should be required. During periodic inspections, look for bypassing or undermining of the entrance and resulting erosion along the sides. Also check the bottom for scour beyond the apron or energy dissipators and remove any debris in the energy dissipators.

Check Dams

Check dams should be checked for sediment accumulation after each significant rainfall. Sediment should be removed when it reaches one-fourth of the original height or before. Regular inspections should be made to ensure that the center of the dam is lower than the edges. Erosion caused by high flows around the edges of the dam should be corrected immediately. If stone check dams are used in grass-lined channels, care must be taken to retrieve any stone that washes downstream.

Waterway Drop Structures

Once the waterway drop structure is constructed and the area around it stabilized, maintenance should be minimal. During routine inspection, however, the channel should be checked for scour above and below the structure. The embankment should be checked to ensure that vegetation is well-established. The structure itself should be checked for cracking of the concrete, uneven settlement, and piping around the structure.

Outlet Protection

Outlets should be inspected after every major storm. Outlet pipes should be in sound structural condition and free of sediment accumulation. Energy dissipators, splash pads, and riprap aprons should be kept free of debris. Look for scour below the outlet. Wherever such erosion is detected, effective measures should be taken quickly to stabilize and protect the affected area.

Other Stormwater Management Structures

Inlets

Pipe inlets should be inspected for clogging and/or structural integrity after each major storm, and accumulated debris and sediment should be removed as required. Trash racks should be cleaned and should be replaced if missing.

Control Structures

In addition to inlets and outlets, many stormwater management facilities have control structures to regulate the rate and/or water level in the facility. These structures must be

inspected frequently for sediment and debris. Control structures should be checked annually by the design engineer for structural integrity.

Maintaining Vegetation

Turf

Turf is used for erosion protection, water treatment, velocity reduction, and aesthetics. Regular mowing and occasional fertilization are required to maintain desired growth. Avoid cutting turf too short; as this may damage the plant, reduce the desirable friction in channels, and reduce the protection to soil. A lack of mowing can lead to invasion by weeds. In areas that impound or convey stormwater, clippings should be bagged and removed to reduce the organic loading.

Trees and Shrubs

Trees and shrubs have a place in stormwater management systems, in places such as wet detention facilities. However, there are many areas where trees and shrubs ***are not desirable!*** Trees and shrubs should be kept off dam and emergency spillway areas. Should these plants die, their large, decaying root systems can seriously reduce the structural integrity of an embankment.

In addition, trees that start to grow in the vicinity of an exfiltration trench or an underdrain system should be removed immediately. This helps to avoid root puncture of the filter fabric through which sediment might enter the structure. When practical, fallen leaves should be removed from stormwater conveyance or impoundment areas.

Tab
Insert

CHAPTER 7: BEST MANAGEMENT PRACTICES—VEGETATION FOR EROSION CONTROL

- 7.1 Introduction
- 7.2 Surface Roughening
- 7.3 Topsoiling
- 7.4 Temporary Seeding
- 7.5 Permanent Seeding
- 7.6 Sodding
- 7.7 Mulching
- 7.8 Trees, Shrubs, Vines, and Ground Covers
- 7.9 Tree Preservation and Protection
- 7.10 Vegetative Streambank Stabilization

* * * * *

7.1 Introduction

The most efficient and cost-effective form of erosion control is prevention. The most cost-effective, environmentally friendly, and aesthetically pleasing form of prevention is through the use of vegetation. Success depends on the proper application, installation, and maintenance of vegetative BMPs, such as those described in this chapter.

7.2 Surface Roughening

Definition

Providing a rough soil surface with horizontal depressions created by operating a tillage implement or other suitable implement on the contour, or by leaving slopes in a roughened condition by not fine-grading them.

Purposes

1. *To aid in the establishment of vegetative cover with seed.*
2. *To reduce runoff velocity and increase infiltration.*
3. *To reduce erosion and provide for sediment trapping.*

Conditions Where Practice Applies

1. *All slopes steeper than 3:1 require surface roughening if they are to be stabilized with vegetation. Acceptable methods include stair-step grading, grooving, furrowing, or tracking.*

2. *Areas with grades less steep than 3:1 should have the soil surface lightly roughened and loosened to a depth of 2 to 4 inches (5 to 10 cm) prior to seeding.*
3. *Areas that have been graded and will not be stabilized immediately may be roughened to reduce runoff velocity until seeding takes place.*

Specifications

Cut Slope Applications for Areas that Will Not Be Mowed

1. *Cut slopes with a gradient steeper than 3:1 shall be stair-step graded or grooved (see **Figures 7.2a** and **7.2b**).*
2. *Stair-step grading may be carried out on any material soft enough to be ripped with a bulldozer. Slopes consisting of soft rock with some subsoil are particularly suited to stair-step grading. The ratio of the vertical cut distance to the horizontal distance shall be less than 1:1, and the horizontal portion of the "step" shall slope toward the vertical wall. Individual vertical cuts shall not be more than 30 inches (75 cm) on soft soil materials and not more than 40 inches (100 cm) in rocky materials.*
3. *Grooving consists of using machinery to create a series of ridges and depressions that run perpendicular to the slope (on the contour). Grooves may be made with an appropriate implement that can be safely operated on the slope and that will not cause undue compaction. Suggested implements include discs, tillers, spring harrows, and the teeth on a front-end loader bucket. Such grooves shall not be less than 3 inches (8 cm) deep or more than 15 inches (38 cm) apart.*

Fill Slope Applications for Areas that Will Not Be Mowed

Fill slopes with a gradient steeper than 3:1 shall be grooved or allowed to remain rough as they are constructed. The options are as follows:

1. *Groove according to Item 2, above.*
2. *As lifts of the fill are constructed, soil and rock materials may be allowed to fall naturally onto the slope surface (see **Figure 7.2a**).*

Colluvial materials (soil deposits at the base of slopes or from old streambeds) shall not be used in fills, as they flow when saturated. At no time shall slopes be bladed or scraped to produce a smooth, hard surface.

Cuts, Fills, and Graded Areas that Will Be Mowed

Mowed slopes should not be steeper than 3:1. Excessive roughness is undesirable where mowing is planned. These areas may be slightly roughened with shallow grooves, such as those that remain after tilling, discing, harrowing, raking, or the use of a cultipacker-seeder. The final pass of any such tillage implement shall be on the contour (perpendicular to the slope). Grooves formed by such implements shall not be less than 1 inch (2.5 cm) deep and not more than 12 inches (30 cm) apart. Fill slopes that are left rough as constructed may be smoothed with a dragline or pickchain to facilitate mowing.

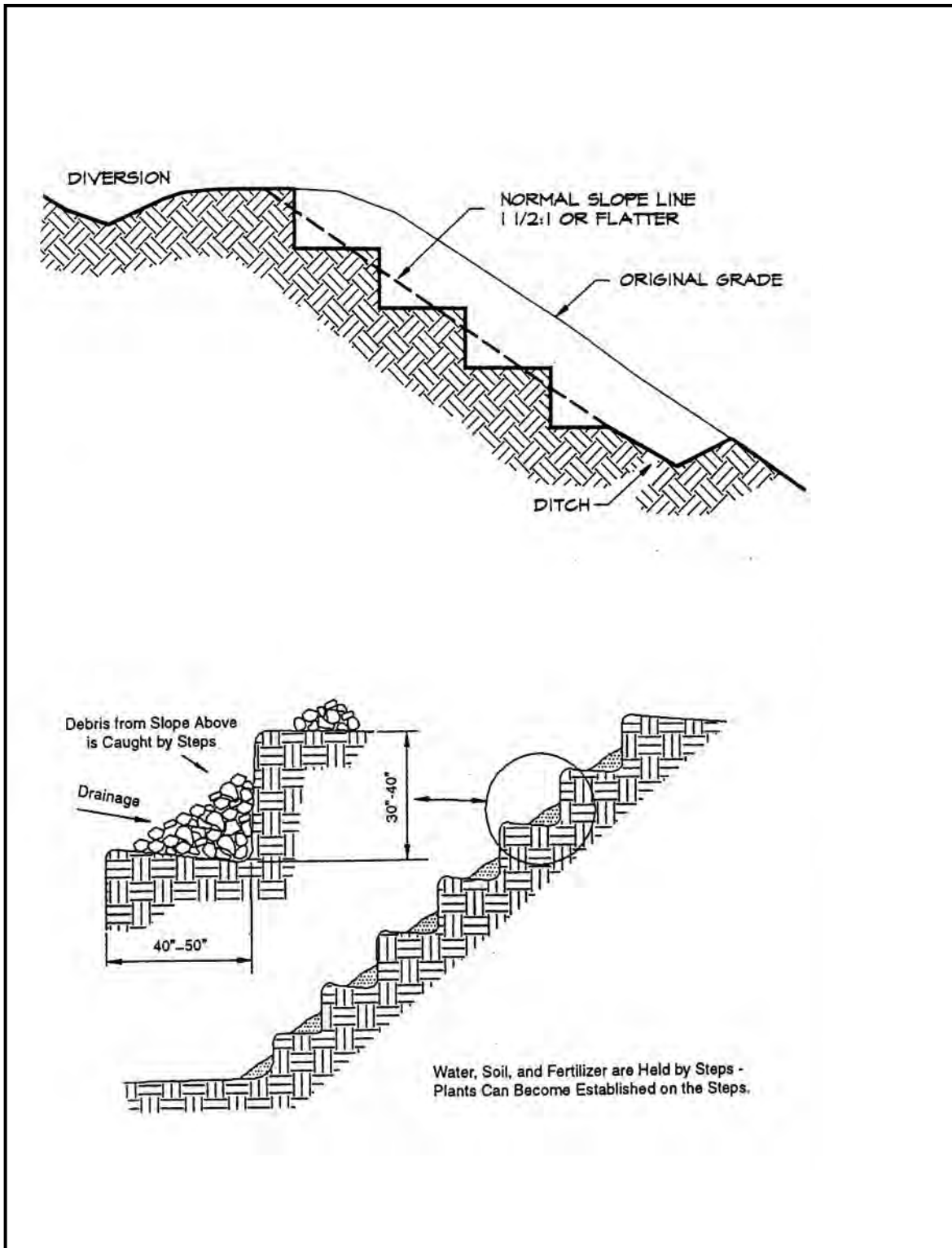

Figure 7.2a. Stair-Stepped Slope

Source: Virginia DSWC; Erosion Draw

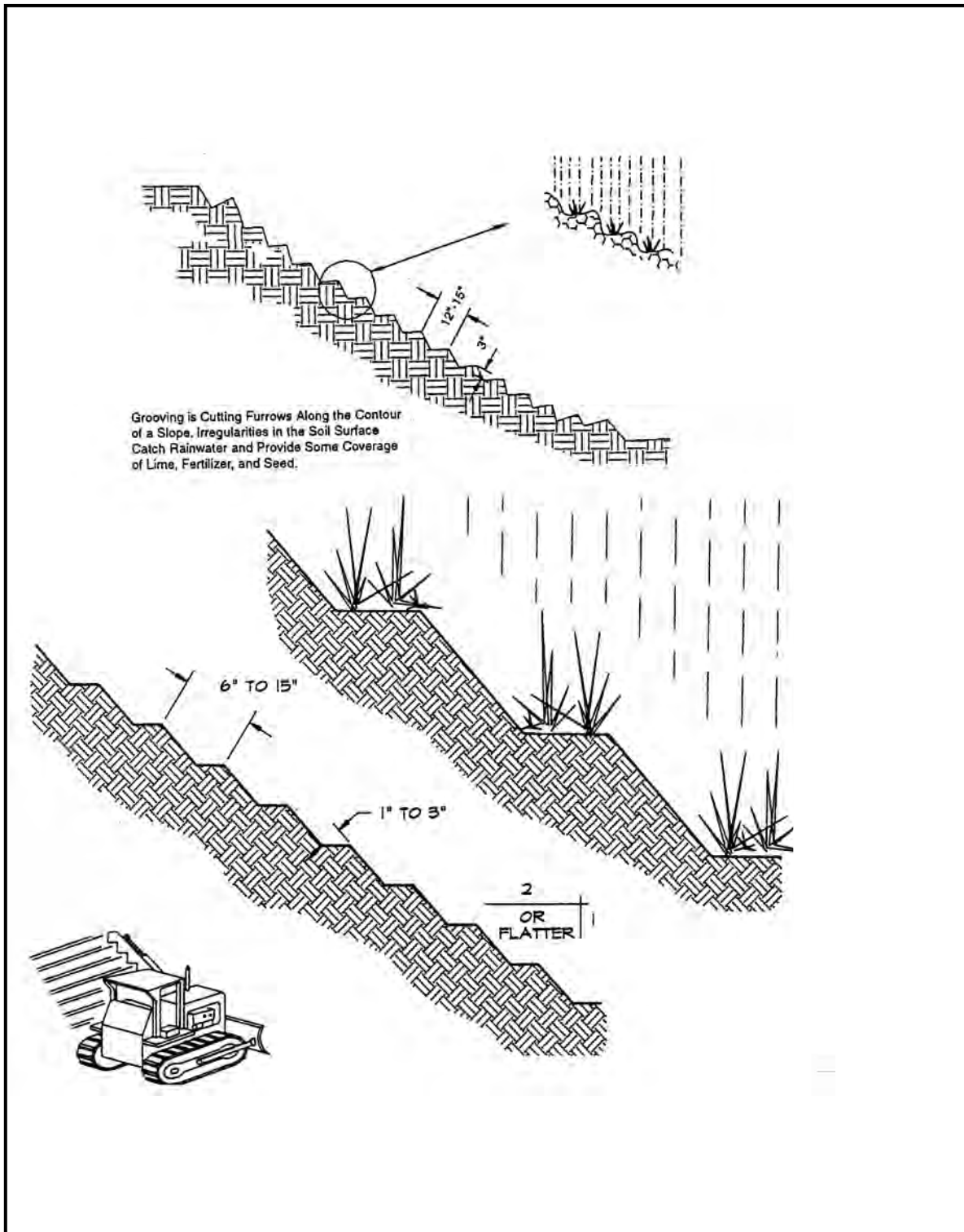

Figure 7.2b. Grooved or Serrated Slope

Source: Erosion Draw

Terracing

Bench terraces consist of one or more diversions placed along a slope to slow and intercept the flow of water. The diversions are constructed either along the contour or sloping gradually to a stabilized waterway. The bench or channel should be at least 6 feet (2 m) wide to allow the use of mowing equipment (see **Figure 7.2c**).

Roughening With Tracked Machinery

Roughening with tracked machinery on clayey soils is not recommended unless no other alternatives are available. This practice unduly compacts the surface soil. Sandy soils do not compact severely and may be tracked. Tracking is not as effective as the other roughening methods described in this chapter.

When tracking is the chosen technique for surface roughening, it shall be done by operating tracked machinery up and down the slope to leave horizontal depressions in the soil. There should be as few passes of the machinery as possible to minimize compaction (see **Figure 7.2d**).

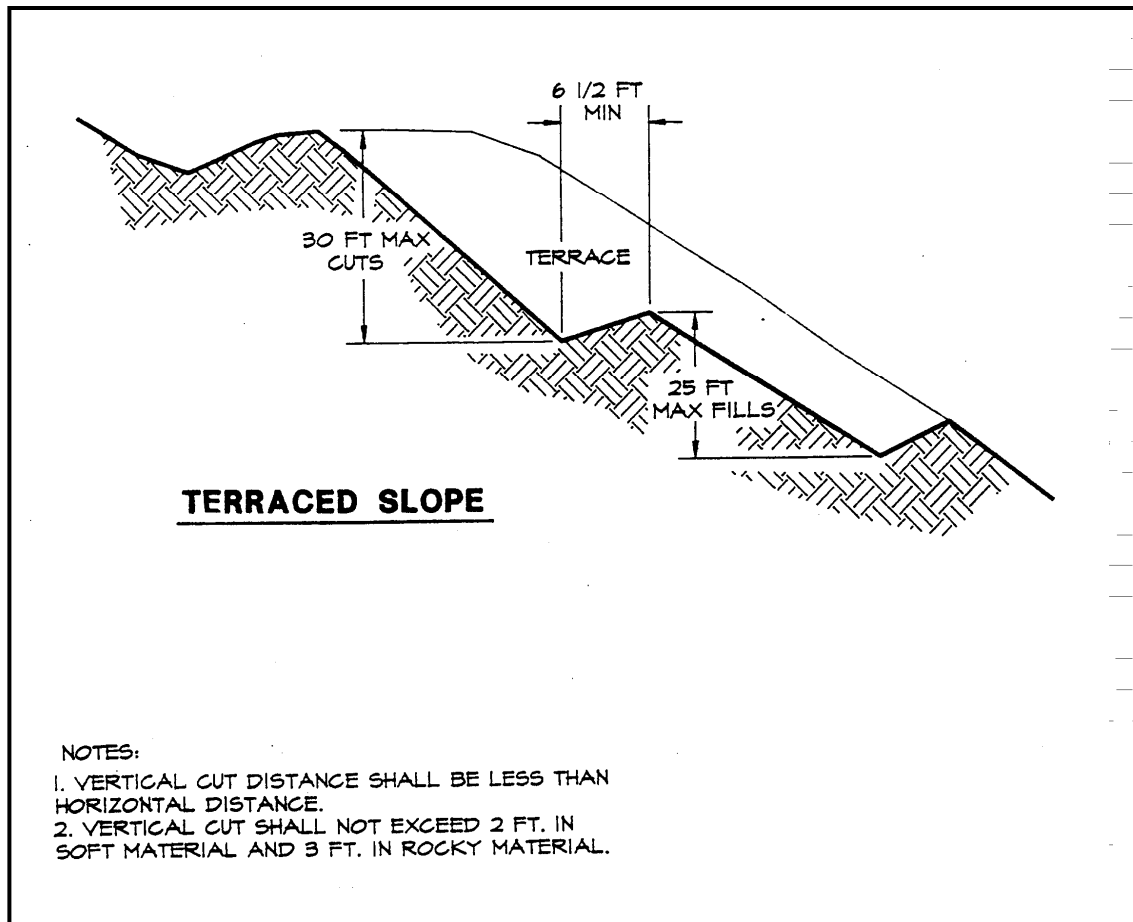

Figure 7.2c. Terraced Slope

Source: Erosion Draw

Seeding

Roughened areas shall be seeded and mulched as soon as possible to obtain optimum seed germination and seedling growth.

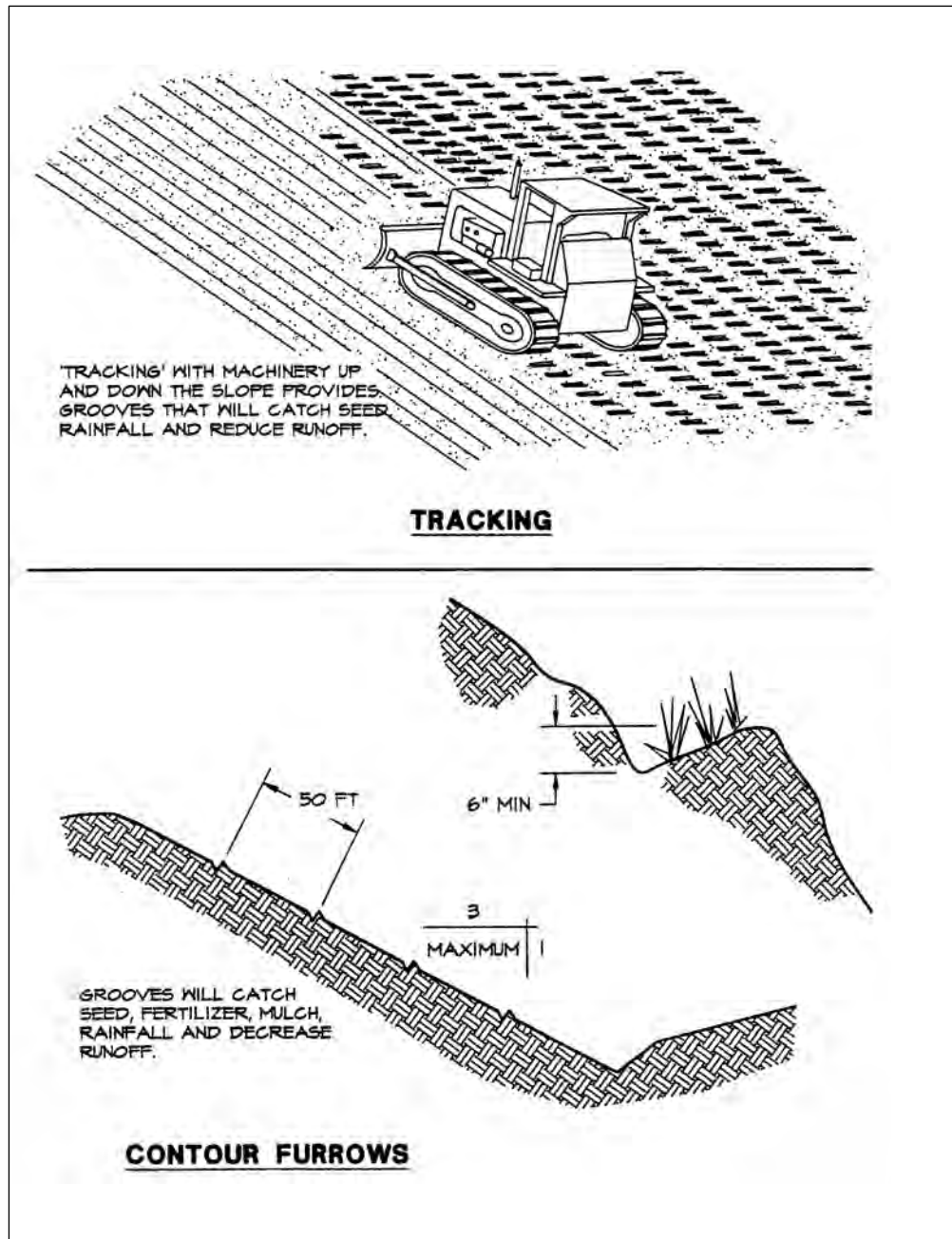

Figure 7.2d. Roughening with Tracked Machinery

Source: Erosion Draw

7.3 Topsoiling

Definition

Methods of preserving and using topsoil to enhance final site stabilization with vegetation.

Purpose

To provide a suitable growth medium for final site stabilization with vegetation.

Conditions Where Practice Applies

1. *Where either the preservation or importation of topsoil is determined to be the most effective method of providing a suitable growth medium.*
2. *Where the subsoil or existing soil presents the following problems:*
 - a. The texture, pH, or nutrient balance of the available soil cannot be modified by reasonable means to provide an adequate growth medium.
 - b. The soil material is too shallow to provide an adequate root zone and to supply necessary moisture and nutrients for plant growth.
 - c. The soil contains substances potentially toxic to plant growth.
3. *Where high-quality turf is desirable to withstand intense use or meet aesthetic requirements.*
4. *Where ornamental plants will be established.*
5. *Only on slopes that are 2:1 or flatter.*

Specifications

Materials

A field evaluation of the site should be made to determine if there is sufficient surface soil of good quality to justify stripping. The topsoil should be friable and loamy (loam, sandy loam, silt loam, sandy clay loam, clay loam). It should be free of debris, trash, stumps, rocks, roots, and noxious weeds, and should be able to support healthy plant growth.

Stripping

Stripping should be confined to the immediate construction area. A 4 to 6 inch (10 to 15 cm) stripping depth is common, but depth may vary depending on the particular soil. All perimeter berms, basins, and other sediment controls shall be in place prior to stripping.

Stockpiling

Topsoil shall be stockpiled so that natural drainage is not obstructed and no offsite sedimentation occurs. Stockpiles should be planned so as not to interfere with any of the construction operations. They can also act as barriers to shield the construction site

from the neighborhood and adjacent landowners, and can help to reduce the amount of dust and noise coming from the site.

The side slopes of the stockpile shall not exceed 2:1. A perimeter berm with gravel outlet, silt fence, or straw bale barrier shall surround all topsoil stockpiles. Temporary seeding of stockpiles shall be completed within 15 days of the formation of the stockpile, in accordance with **TEMPORARY SEEDING** (in this chapter).

Site Preparation Prior to and Maintenance during Topsoiling

Before topsoiling, establish needed erosion and sediment control practices such as diversions, grade stabilization structures, berms, level spreaders, waterways, and sediment basins. These practices must be maintained during topsoiling. The following guidelines should be used for site preparation and maintenance:

1. **Grading** – *Previously established grades on the areas to be topsoiled shall be maintained according to the approved plan.*
2. **Liming** – *Where the pH of the subsoil is 6.0 or less, or the soil is composed of heavy clays, agricultural limestone shall be spread in accordance with the soil test or the vegetative establishment practice being used.*
3. **Bonding** – *After the areas to be topsoiled have been brought to grade, and immediately prior to dumping and spreading the topsoil, the subgrade shall be loosened by discing or scarifying to a depth of at least 2 inches (5 cm) to ensure bonding of the topsoil and subsoil.*

Applying Topsoil

Topsoil shall not be placed while in a muddy condition, when the subgrade is excessively wet, or in a condition that may otherwise be detrimental to proper grading or proposed sodding or seeding. The topsoil shall be uniformly distributed to a minimum compacted depth of 2 inches (5 cm) on 3:1 or steeper slopes, and 4 inches (10 cm) on flatter slopes. Any irregularities in the surface resulting from topsoiling or other operations shall be corrected to prevent the formation of depressions or water pockets.

The topsoil should be compacted enough to ensure good contact with the underlying soil and a level seedbed for the establishment of high-maintenance turf. However, undue compaction is to be avoided, as it increases runoff velocity and volume, and deters seed germination. In areas that are not going to be mowed, the surface should be left rough, as described in **SURFACE ROUGHENING** (in this chapter).

Soil Sterilants

No sod or seed shall be placed on soil that has been treated with soil sterilants until enough time has elapsed to permit the toxic materials to dissipate.

7.4 Temporary Seeding

Definition

The establishment of temporary vegetative cover on disturbed areas by seeding with appropriate, rapidly growing annual plants.

Purposes

1. *To reduce erosion and sedimentation by stabilizing disturbed areas that will not be brought to final grade within 7 days or more.*
2. *To reduce problems associated with mud and dust production from bare soil surfaces during construction.*

Conditions Where Practice Applies

Where exposed soil surfaces are not to be fine graded for periods of 7 days or more. Such areas include denuded areas, soil stockpiles, berms, dams, the sides of sediment basins, and temporary road banks.

Specifications

Prior to seeding, install necessary erosion control practices such as berms, waterways, and basins.

Plant Selection

Select plants appropriate to the season, region, and site conditions. Consult with your local Agricultural Extension agent, county, FDEP, water management district, or FDOT office, or see Table 1.65a of the *Florida Development Manual*.

Seedbed Preparation

To control erosion on bare soil surfaces, plants must be able to germinate and grow. Seedbed preparation is essential. A soil test should be taken to determine liming and fertilization requirements. In the absence of a soil test, the following guidelines apply:

1. **Liming** – *Where soils are known to be highly acid (pH 6.0 and lower), lime should be applied at the rate of 2 tons of pulverized agricultural limestone per acre.*
2. **Fertilizer** – *Shall be applied as 217.5 pounds per acre (5 pounds/ 1,000 square feet) (504 kg/ha) of 50% slow-release 10-20-20 or equivalent. Lime and fertilizer shall be incorporated into the top 2 to 4 inches (5 to 10 cm) of the soil. If quick-release nitrogen is used, apply 2 to 3 weeks after seed has sprouted.*
3. **Surface Roughening** – *If the area has been recently loosened or disturbed, no further roughening is required. When the area is compacted, crusted, or hardened, the soil surface shall be loosened by discing, raking, harrowing, or other acceptable means (see **SURFACE ROUGHENING** [in this chapter]).*

4. **Tracking** – *Tracking with bulldozer cleats is most effective on sandy soils. This practice often causes the undue compaction of the soil surface, especially in clayey soils, and does not aid plant growth as effectively as other methods of surface roughening.*

Seeding

Seed shall be evenly applied with a cyclone seeder, drill, cultipacker-seeder, or hydroseeder. Small grains shall be planted no more than 1 inch deep. Grasses and legumes shall be planted no more than ¼ inch (6 mm) deep.

Mulching

1. *Mulch should usually be applied to reduce damage from water runoff or wind erosion, and to improve moisture conditions for seedlings. Mulching without seeding should be considered for very short-term protection. The use of mulch is a judgment decision based on the time of seeding and conditions of individual sites. When used, mulch shall be applied according to **MULCHING** (in this chapter).*
2. *Seedings made on slopes in excess of 3:1, or on adverse soil conditions, or during excessively hot or dry weather, shall be mulched according to **MULCHING** (in this chapter).*
3. *Seedings made during optimum spring and summer seeding dates, with favorable soil and site conditions, may not require mulch.*

Reseeding

Areas that fail to establish enough vegetative cover to prevent rill erosion will be filled in with proper topsoil and reseeded as soon as they are identified.

7.5 Permanent Seeding

Definition

The establishment of perennial vegetative cover on disturbed areas by planting seed.

Purposes

1. *To reduce erosion and decrease sediment yield from disturbed areas.*
2. *To permanently stabilize disturbed areas in a manner that is economical and adaptable to site conditions, and that allows the selection of the most appropriate plant materials.*

Conditions Where Practice Applies

1. *Disturbed areas where permanent, long-lived vegetative cover is needed to stabilize the soil.*
2. *Rough-graded areas that will not be brought to final grade for a year or more.*

Specifications

Selection of Plant Materials

1. *The selection of plant materials is based on climate, topography, soils, land use, and planting season. To determine which plant materials are best adapted to a specific site, see Tables 1.66b and 1.66c of the Florida Development Manual, which describe plant characteristics and list recommended varieties.*
2. *Table 1.66a of the Florida Development Manual lists appropriate seeding mixtures for various site conditions in Florida. These mixtures are designed for general use and are known to perform well on the sites described. Adhere to these mixtures whenever feasible. Check Tables 1.66b and 1.66c for recommended varieties.*

Seedbed Requirements

Vegetation should not be established on slopes that are unsuitable because of inappropriate soil texture, poor internal structure or internal drainage, a high volume of overland flow, or excessive steepness, until measures have been taken to correct these problems.

To maintain a good stand of vegetation, the soil must meet certain minimum requirements as a growth medium. ***The existing soil must meet the following criteria:***

1. *Enough fine-grained material to maintain adequate moisture and nutrient supply.*

2. *Sufficient pore space to permit root penetration. A bulk density of 1.2 to 1.5 indicates that sufficient pore space is present. A fine granular or crumb-like structure is also favorable.*
3. *Sufficient depth to provide an adequate root zone. The depth to rock or impermeable layers such as hardpans shall be 12 inches (30 cm) or more, except on slopes steeper than 2:1, where the addition of soil is not feasible.*
4. *A favorable pH range for plant growth. If the soil is so acid that a pH range of 6.0 to 7.0 cannot be attained by the addition of pH-modifying materials, then the soil is unsuitable for plant roots.*
5. *Freedom from toxic amounts of materials harmful to plant growth.*
6. *Freedom from excessive quantities of roots, branches, large stones, large clods of earth, or trash of any kind. Clods and stones may be left on slopes steeper than 3:1 if they are to be hydroseeded.*

If any of the above criteria cannot be met—i.e., if the existing soil is too coarse, dense, shallow, acid, or contaminated to foster vegetation—then topsoil should be applied in accordance with **TOPSOILING** (in this chapter). The necessary mechanical erosion and sediment control practices **will be installed prior to seeding**. Grading will be carried out according to the approved plan. Surfaces will be roughened in accordance with **SURFACE ROUGHENING** (in this chapter).

Soil Conditioners

To modify the texture, structure, or drainage characteristics of a soil, the following materials **may** be added to the soil:

1. ***Peat** shall be sphagnum moss peat, hypnum moss peat, reed-sedge peat, or peat humus, from freshwater sources. Peat shall be shredded and conditioned in storage piles for at least 6 months after excavation.*
2. ***Sand** shall be clean and free of toxic materials.*
3. ***Vermiculite** shall be horizontal grade and free of toxic substances.*
4. ***Composted manure** shall be stable or cattle manure not containing undue amounts of straw or other bedding materials or toxic chemicals. Phosphorus shall be limited to soil test recommendations.*
5. ***Thoroughly rotted sawdust** shall be 6 pounds of nitrogen added to each cubic yard (3.5 kg/m³) and shall be free of stones, sticks, and toxic substances.*
6. *Where local ordinances permit, **treated sewage sludge** may be used in accordance with local, state, and federal regulations. The use of treated sewage sludge shall be limited to soil test recommendations.*

Lime and Fertilizer

Lime and fertilizer needs should be determined by soil tests. Soil tests may be performed by the Cooperative Extension Service Soil Testing Laboratory at the University of Florida, or by a reputable commercial laboratory. Information on the state's

Soil Testing Laboratory is available from county extension agents. Under unusual conditions where it is not possible to obtain a soil test, the following soil amendments will be applied:

LIME: 2 tons per acre finely ground agricultural or dolomitic limestone (90 pounds per 1,000 square feet) (4.48 t/ha)

FERTILIZER: Mixed grasses and legumes: 150 pounds per acre of 5-25-10 (3.5 pounds per 1,000 square feet)

Legume stands only: 150 pounds per acre of 5-20-10 (3.5 pounds per 1,000 square feet)

Grass stands only: 870 pounds per acre of 5-5-10 (1.12 t/ha) and 57 pounds of 38-0-0 in spring (1.3 pounds per 1,000 square feet)

220 pounds per acre of 10-5-10 and 57 pounds of 38-0-0 in fall (1.3 pounds per 1,000 square feet)

Other fertilizer formulations may be used, provided they supply the same amounts and proportions of plant nutrients.

Lime and fertilizer shall be incorporated into the top 4 to 6 inches (10 to 15 cm) of the soil by discing or other means. When applying lime and fertilizer with a hydroseeder, apply to a rough, loose surface.

Seeding

1. **Certified seed** should be used for all permanent seeding whenever possible.
2. **Legume seed** should be inoculated with the inoculant appropriate to the species. The seed of lespedezas, crown vetch, and clovers should be scarified to promote uniform germination.
3. **Apply seed uniformly** with a cyclone seeder, drill, cultipacker-seeder, or hydroseeder on a firm, friable seedbed. The maximum seeding depth should be $\frac{1}{4}$ inch.
4. During **hydroseeding**, to avoid seed damage, it is recommended that if a machinery breakdown of 30 minutes to 2 hours occurs, 50% more seed be added to the tank, based on the proportion of the slurry remaining in the tank. Beyond 2 hours, a full rate of new seed may be necessary.

Often hydroseeding contractors prefer not to apply lime in their rigs, as it is abrasive. In inaccessible areas, lime may have to be applied in pelletized or liquid form, separately. The rates of wood fiber should be at least 2,000 pounds per acre (2.24 t/ha). Surface roughening is particularly important when hydroseeding, as a roughened slope provides some natural coverage of lime, fertilizer, and seed.

5. **Legume inoculants** should be used by the date indicated on the container. When dry seeding, use 4 times the manufacturer's

recommended rate, and use 10 times the recommended rate of inoculant when hydroseeding.

Mulching

All permanent seeding must be mulched immediately upon the completion of seed application (refer to the extended discussion in **MULCHING** below).

Maintenance of New Seedings

1. **Irrigation** – *New seedlings should be supplied with adequate moisture. Supply water as needed, especially late in the season, in abnormally hot or dry weather, or on adverse sites. Water application rates should be controlled to prevent runoff. Inadequate amounts of water may be more harmful than no water.*
2. **Reseeding** – *Inspect seeded areas for failure and make necessary repairs and reseedings within the same season, if possible:*
 - a. If vegetative cover is inadequate to prevent rill erosion, overseed and fertilize in accordance with soil test results.
 - b. If a stand has less than 40% cover, re-evaluate the choice of plant materials and quantities of lime and fertilizer. Re-establish the stand following seedbed preparation and seeding recommendations, omitting lime and fertilizer in the absence of soil test results. **NOTE:** If vegetation has failed to grow, the soil must be tested to determine if acidity or nutrient imbalances are responsible.
3. **Fertilization** – *Seedlings should be fertilized 1 year after planting to ensure proper stand density:*
 - a. To established all-grass stands, apply 300 pounds per acre of 15-0-15 or 15-2-15 slow release (6.7 pounds per 1,000 square feet) between August 15 and November 15 (the first fall following seeding).
 - b. To legume-and-grass stands or pure legume stands, apply 150 pounds per acre of 0-20-20 (3.5 pounds per 1,000 square feet) in early May, or between August 15 and October 15.

GENERALLY, A STAND OF VEGETATION IS NOT DETERMINED TO BE FULLY ESTABLISHED UNTIL SOIL COVER HAS BEEN MAINTAINED FOR 1 FULL YEAR FROM PLANTING. DISTURBED AREAS THAT ARE TO BE STABILIZED WITH PERMANENT VEGETATION MUST BE SEEDED OR PLANTED WITHIN 15 DAYS AFTER FINAL GRADE IS REACHED, UNLESS TEMPORARY STABILIZATION IS APPLIED.

7.6 Sodding

Definition

Stabilizing fine-graded disturbed areas by establishing permanent grass stands with sod.

Purposes

1. *To establish permanent turf immediately.*
2. *To prevent erosion and damage from sediment and runoff by stabilizing the soil surface.*
3. *To reduce the production of dust and mud associated with bare soil surfaces.*
4. *To stabilize drainageways where concentrated overland flow will occur.*

Conditions Where Practice Applies

1. *Disturbed areas that require immediate vegetative covers, or where sodding is preferred to other means of grass establishment.*
2. *The following locations are particularly suited to stabilization with sod:*
 - a. *Slopes and buffer strips.*
 - b. *Waterways and swales, especially around drop inlets.*
 - c. *Residential or commercial lawns where quick use or aesthetics are factors.*

Specifications

Soil Preparation

1. *Prior to soil preparation, areas to be sodded shall be brought to final grade in accordance with the approved plan. These operations should leave as much topsoil as possible or replace the topsoil to a depth of 4 inches (10 cm) (see **Figure 7.6a**).*
2. *Soil tests should be carried out to determine the exact requirements for lime. They may be conducted by the state Soil Testing Laboratory at the University of Florida or a reputable commercial laboratory. Information on state soil tests is available from county Cooperative Extension agents.*

*When a soil test is not carried out, **pulverized agricultural limestone** may be added at a rate of 100 pounds per 1,000 square feet (2 tons/acre).*
3. *Before sod is laid, the soil surface shall be clear of trash, debris, roots, branches, stones, and clods more than 2 inches (5 cm) in length or diameter. Sod shall not be applied to gravel or other non-soil surfaces.*

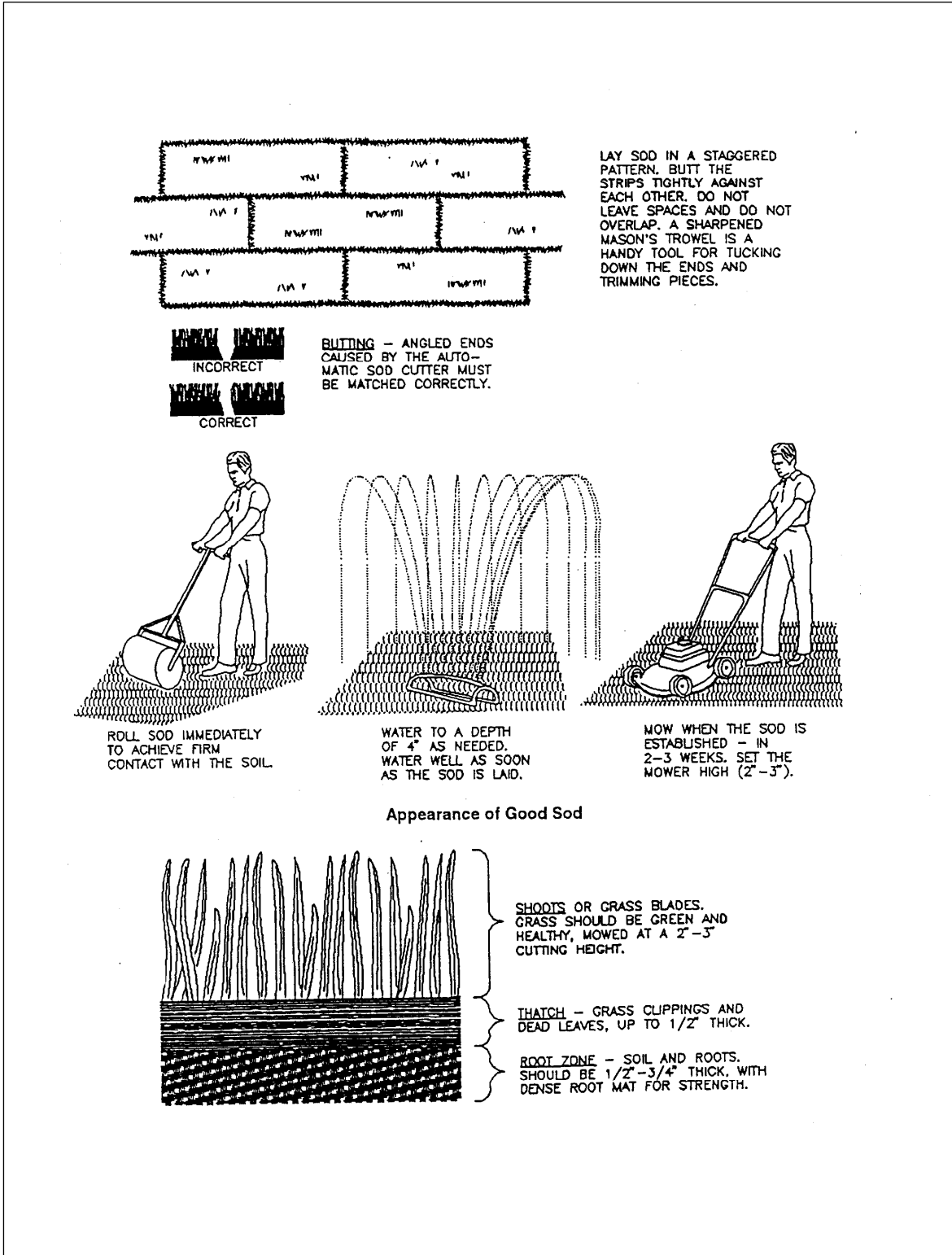

Figure 7.6a. Sodding

Source: Virginia DSWC

4. Any irregularities in the soil surface resulting from topsoil or other operations shall be filled or leveled to prevent the formation of depressions or water pockets.
5. Areas to be topsoiled and the topsoil used shall fulfill the requirements of **TOPSOILING** (in this chapter). No sod shall be spread on soil that has been treated with soil sterilants until enough time has elapsed to permit the dissipation of toxic materials.

Sod Quality

1. Sod should be free of weeds and undesirable coarse weedy grasses. If possible, **Certified** or **Approved** turfgrass sod should be used.
2. Sod shall be machine cut at a uniform soil thickness of $\frac{3}{4}$ inch (20 mm), plus or minus $\frac{1}{4}$ inch (6 mm), at the time of cutting. This thickness shall exclude shoot growth and thatch.
3. Pieces of sod shall be cut to the supplier's standard width and length, with a maximum allowable deviation in any dimension of 5%. Torn or uneven pads are not acceptable.
4. Standard-size sections of sod shall be strong enough to support their own weight and retain their size and shape when suspended from a firm grasp on one end of the section.
5. Sod shall not be cut or laid in excessively wet or dry weather.
6. Sod shall be harvested, delivered, and installed within 36 hours.

Installation

Solid Sodding

1. Irrigate areas to be sodded with a minimum of $\frac{1}{2}$ inch (13 mm) of water, unless recent rains have provided an equivalent amount of moisture (see **Figure 7.6b**).
2. The first row of sod shall be laid in a straight line, with subsequent rows placed parallel to and butting tightly against each other. Lateral joints shall be staggered to promote more uniform growth and strength. Care shall be exercised to ensure that the sod is not stretched or overlapped and that all joints are butted tightly to prevent voids that would dry out the roots.

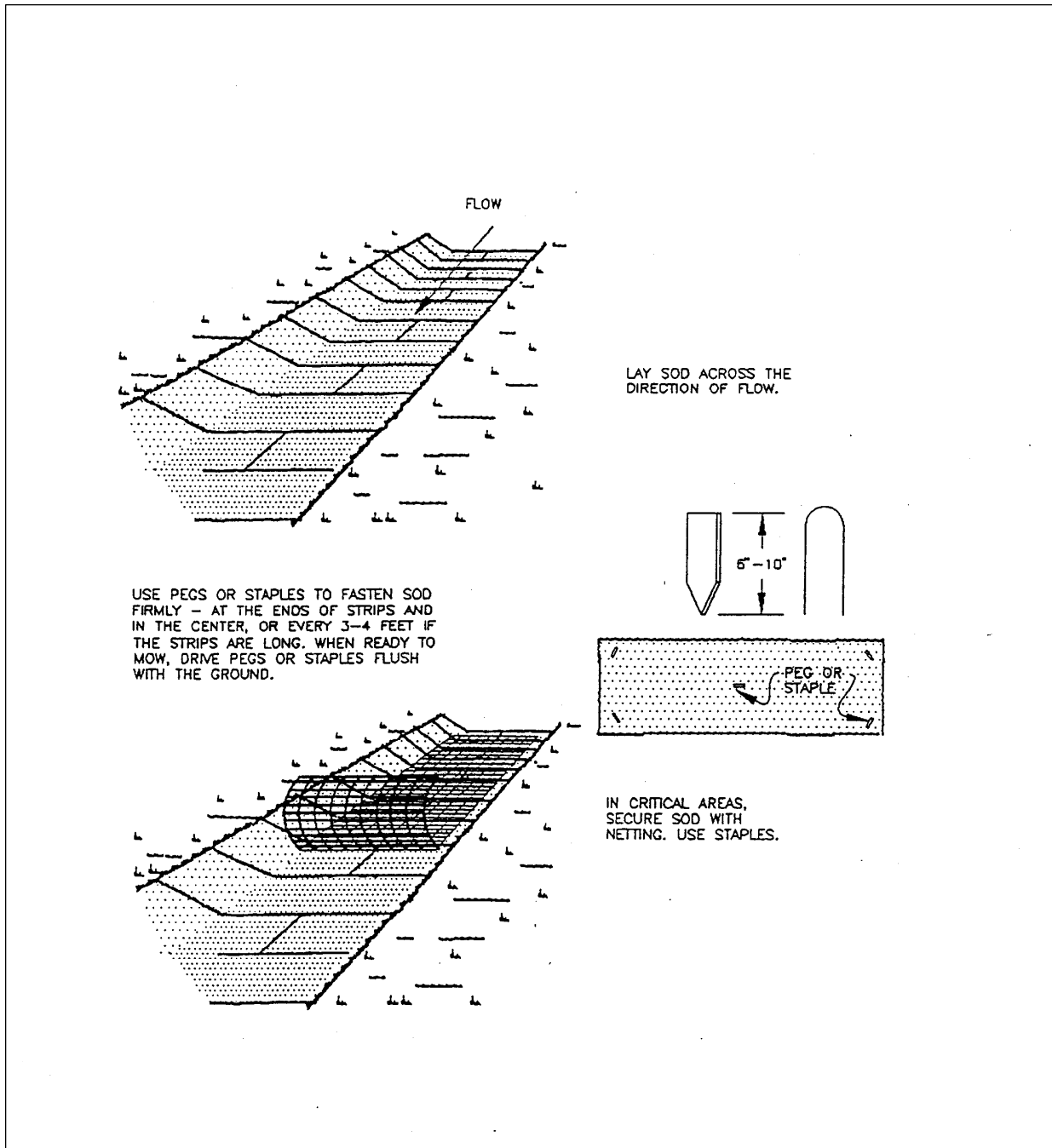

Figure 7.6b. Sodding Swales and Waterways

Source: Virginia DSWC

3. *On slopes of 3:1 or greater, or wherever erosion may be a problem, sod shall be laid with staggered joints and secured by pegging or other approved methods. Sod shall be installed with the length perpendicular to the slope (on the contour). Begin laying sod at the bottom of the slope and work uphill. On very steep slopes, the use of ladders facilitates the work and prevents damage to the sod.*
4. *Surface water flow cannot always be diverted from the face of the slope, but a capping strip of heavy jute or erosion netting, properly secured, along the crown of the slope provides extra protection against the lifting and undercutting of sod. The same technique is used to fortify sod in water-carrying channels and other critical areas. Use wire staples to anchor heavy jute or erosion netting in channels.*
5. *As the sodding of clearly defined areas is completed, sod shall be rolled or tamped to provide firm contact between roots and soil.*
6. *After rolling, sod shall be irrigated deeply enough that the underside of the sod pad and the soil 4 inches (10 cm) below the sod are thoroughly wet.*
7. *During the first week, in the absence of adequate rainfall, watering shall be performed as often as necessary to maintain moist soil to a depth of at least 4 inches (10 cm).*
8. *The first mowing shall not be attempted until the sod is firmly rooted, usually after 2 to 3 weeks. Not more than one-third of the grass leaf should be removed at any one cutting.*
9. *Two to 4 weeks after sod is laid, fertilize at an application rate of 300 pounds per acre or 6.7 pounds per 1,000 square feet with 15-0-15 or 15-2-15 slow release.*

Spot Sodding

1. *Spot sodding is the planting of plugs or blocks, a minimum of 4 inches (10 cm) in diameter or square, of sod at measured intervals. The plugs or blocks should be placed 1 foot (30 cm) apart.*
2. *Sod spots in a row should be placed alternately and not directly opposite sod spots in adjacent rows.*
3. *Fit the plugs or blocks tightly into the prepared holes and tamp them firmly into place.*
4. *Irrigate deeply enough that the underside of the sod spot and the soil 4 inches (10 cm) below the sod are thoroughly wet.*

Strip Sodding

1. *Areas to be strip sodded should be fertilized, limed, prepared, and smoothed as in solid sodding.*
2. *Lay the strips end to end in rows 1 to 1½ feet (30 to 45 cm) apart, with the strips a minimum of 2 to 4 inches (5 to 10 cm) wide.*

3. Roll or tamp the strips thoroughly to create firm contact between roots and soil.
4. Irrigate deeply enough that the underside of the strips and the soil 4 inches (10 cm) below the strips are wet.

Sodded Swales and Waterways

1. Care should be taken to prepare the soil adequately in accordance with this specification. The sod type shall consist of plant materials able to withstand the designed velocity (see **STORMWATER CONVEYANCE CHANNEL**) (in **Chapter 6**).
2. Sod strips in swales and waterways shall be laid perpendicular to the direction of flow. Care should be taken to butt the ends of the strips tightly.
3. After rolling or tamping, sod shall be pegged or stapled to resist washout during the establishment period. Chicken wire, jute, or other netting may be pegged over the sod for extra protection in critical areas.
4. All other specifications for this practice shall be adhered to when sodding a swale or waterway.

Maintaining Established Sod

1. After the first week, sod shall be watered as necessary to maintain adequate moisture in the root zone and prevent dormancy.
2. Apply lime and fertilizer under a regular program based on soil tests and on the use and general appearance of the vegetative cover. In the absence of a soil test, apply 1 to 2 tons per acre (45 to 90 pounds/1,000 square feet) (2.24 to 4.48 t/ha) of finely ground agricultural limestone every 3 years. Apply 300 pounds per acre (6.7 pounds/1,000 square feet) of 15-0-15 or 15-2-15 slow-release fertilizer in the spring and fall.
3. Mow to control weeds, improve the appearance of the vegetative cover, and reduce fire hazard, as necessary. In general, the coarser the leaf texture of the grass, the higher it should be cut. Continuous, close mowing results in a loss of vigor and reduced stand. No more than one-third of the grass leaf should be removed in any mowing.

7.7 Mulching

Definition

The application of plant residues or other suitable materials to the soil surface.

Purposes

1. To prevent erosion by protecting the soil surface from raindrop impacts and reducing the velocity of overland flow.
2. To foster the growth of vegetation by increasing available moisture and providing insulation against extreme heat and cold.

Conditions Where Practice Applies

1. Areas that have been permanently seeded should be mulched immediately after seeding.
2. Areas that cannot be seeded because of the season should be mulched to temporarily protect the soil surface. An organic mulch (not wood fiber alone) shall be used, and the area should then be seeded as soon as feasible in spring.
3. Mulch shall be used together with plantings of trees, shrubs, or certain ground covers that do not provide adequate soil stabilization by themselves.
4. Mulch shall be used in conjunction with the temporary seeding operations specified in **TEMPORARY SEEDING** (in this chapter).
5. Mulches used in areas of concentrated flows or frequent inundation shall be properly anchored to prevent them from floating away.

Specifications

Types of Mulches

1. **Organic Mulches** – Organic mulches may be used in any area where mulch is required, subject to the restrictions noted in **Table 7.1**. Select mulch material based on site requirements, the availability of materials, and the availability of labor and equipment. The table lists the most commonly used organic mulches. Other materials, such as peanut hulls and cotton burs, may also be used.

Mulch materials shall be spread uniformly, by hand or machine. When spreading straw by hand, divide the area to be mulched into approximately 1,000-square-foot sections and place 70 to 90 pounds (1½ to 2 bales) (30 to 40 kg) of straw in each section, to facilitate uniform distribution.
2. **Nets, Mats, and Blankets** – Nets may be used alone on level areas, on slopes no steeper than 3:1, and in waterways, as specified in **STORMWATER CONVEYANCE CHANNEL** (in **Chapter 6**). When mulching is done in late fall or during June, July, or August, **or** where soil is highly erodible, net should only be used in conjunction with an organic

mulch such as straw. When net and organic mulch are used together, the net should be installed over the mulch, except when the mulch is wood fiber. Wood fiber may be sprayed on top of the installed net. Excelsior binders are protective mulches and may be used alone on erodible soils and during all times of year.

Jute net shall be heavy, uniform cloth woven of single jute yarn, which if 36 to 48 inches (90 to 120 cm) wide shall weigh an average of 1.2 pounds per linear yard (0.6 kg/m). Other products designed to control erosion shall conform to the manufacturer's specifications and should be applied in accordance with the manufacturer's instructions, provided those instructions are at least as stringent as this specification. Examples of these products include Erosionet, Holdgro, Weedchek, and Curlex.

(NOTE: *The use of trade names does not constitute a product endorsement by FDEP). In no case shall these products cover less than 30% of the soil surface.*

Table 7.1. Organic Mulch Materials and Application Rates

Mulches	Rate Per Acre	Rate Per 1,000 Square Feet	Notes
Straw	1.5 – 2 tons	70 – 90 pounds.	Free from weeds and coarse matter. Must be anchored. Spread with mulch blower or by hand.
Wood Fibers	0.5 – 1.0 tons	25 – 50 pounds	Fibers 1.5 inch minimum length. Do not use alone in winter or during hot, dry weather. Apply as slurry.
Corn Stalks	4 – 6 tons	185 – 275 pounds	Cut or shredded in 4 to 6 inch lengths. Air dried. Do not use in fine turf areas. Apply with mulch blower or by hand.
Wood Chips	4 – 6 tons	185 – 275 pounds	Free of coarse matter. Air dried. Treat with 12 pounds nitrogen per ton. Do not use in fine turf areas. Apply with mulch blower or chip handler, or by hand.
Shredded Bark Chips	50 – 70 cubic yards	1 – 2 cubic yards	Free of coarse matter. Air dried. Do not use in fine turf areas. Apply with mulch blower or chip handler, or by hand.

Source: Virginia SWCC

3. Chemical Mulches – *Chemical mulches may be used alone only in the following situations:*

- a. Where no other mulching material is available.
- b. In conjunction with temporary seeding when mulch is not required for that practice.
- c. From May 1 to June 15 and September 15 to October 15, provided that they are used on areas with slopes no steeper than 4:1 that have been roughened in accordance with **SURFACE ROUGHENING** (in this chapter).

Installation

Prior to mulching, the following activities should be carried out:

1. *As required, shape and grade the waterway, channel, slope, or other area to be protected.*
2. *Remove all rocks, clods, or debris larger than 2 inches in diameter that will prevent contact between the net and the soil surface.*
3. *Lime and fertilizer should be incorporated and the surface roughened as needed. Seed should be applied prior to mulching, except in the following cases:*
 - a. *Where seed is to be applied as part of a hydroseeder slurry containing wood fiber mulch.*
 - b. *Where seed is to be applied following a straw mulch spread during the winter months.*
 - c. *Where a hydroseeder slurry is applied over straw.*

Mulch Anchoring

Straw mulch must be anchored immediately after spreading to prevent windblow. The other organic mulches listed in **Table 7.1** do not require anchoring. The following methods of anchoring straw may be used:

1. **Mulch Anchoring Tool** – *A tractor-drawn implement is used to punch mulch into the soil surface. This method provides maximum erosion control with straw. It is limited to use on slopes no steeper than 3:1, where equipment can operate safely. Machinery shall be operated on the contour.*
2. **Liquid Mulch Binders** – *The application of liquid mulch binders and tackifiers should be heaviest at the edges of areas and at the crests of ridges and banks, to prevent windblow. Binders should be applied uniformly over the rest of the area. They may be applied after mulch is spread or may be sprayed into the mulch as it is being blown onto the soil. Applying straw and binder together is the most effective method.*

Chemical binders such as Petroset, Terratack, Road Oyl, and Aerospray may be used as recommended by the manufacturer to anchor mulch. These are expensive and therefore are usually used in small areas or in residential areas where asphalt may be a problem. (NOTE: The use of trade names does not constitute a product endorsement by FDEP.)
3. **Mulch Nets** – *Lightweight plastic, cotton, or paper nets may be stapled over the mulch. The nets shall be secured by stakes, staples, or pins according to the manufacturer's recommendations (see **Figure 7.7a** for details).*

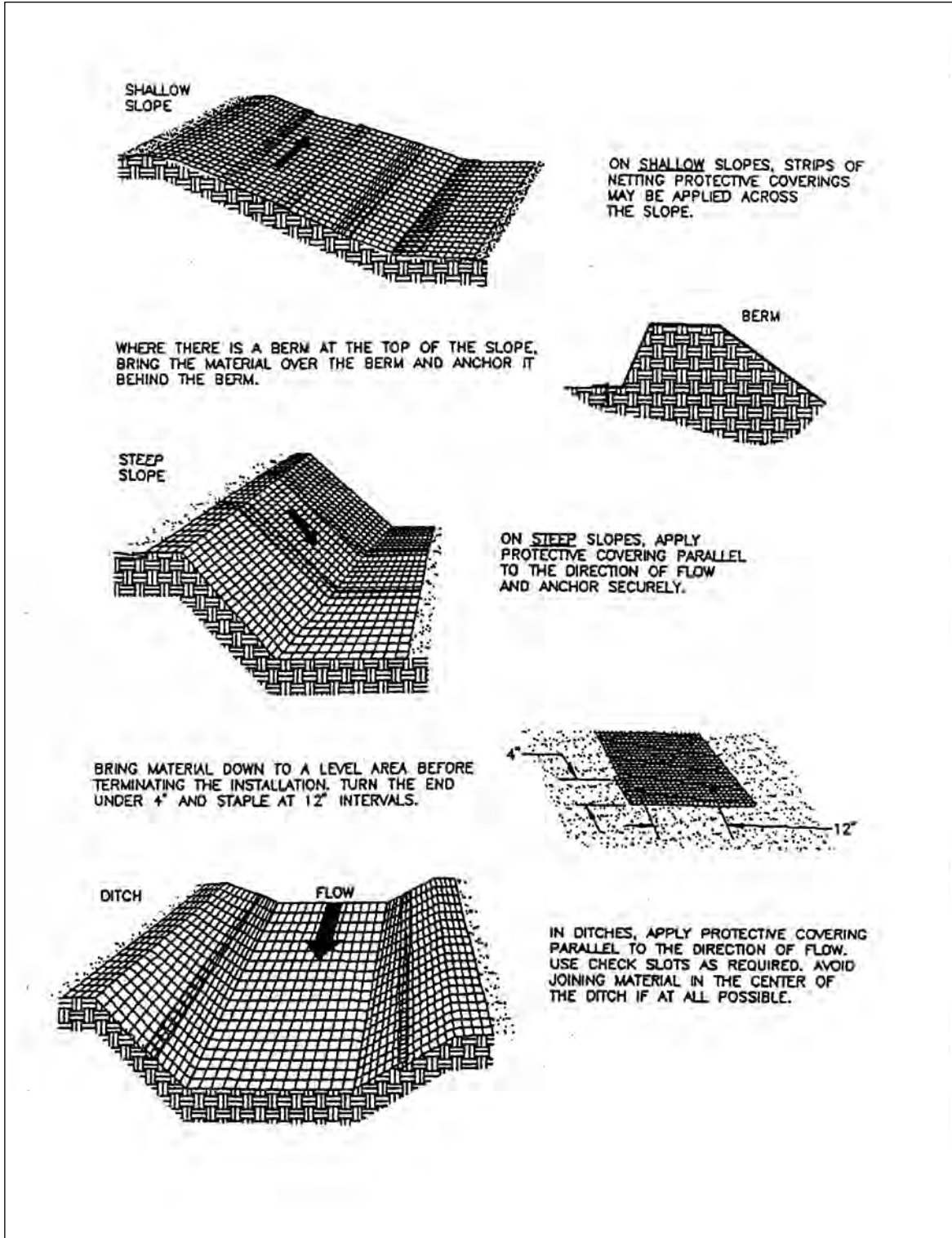

Figure 7.7a. Typical Orientation of Treatment 1 – Soil Stabilization Blanket

Source: Adapted from Ludlow Products Brochure

4. **Peg and Twine** – *Because it is labor intensive, this method is feasible only in small areas where other methods cannot be used. Drive 8 to 10 inch (20 to 25 cm) wooden pegs to within 3 inches (8 cm) of the soil surface every 4 feet (1.2 m) in all directions. Stakes may be driven before or after straw is spread. Secure mulch by stretching twine between pegs in a criss-cross-within-a-square pattern. Turn twine 2 or more times around each peg.*

Laying Nets, Mats, and Blankets

Nets, mats, and blankets should be installed according to the manufacturer's instructions, provided that these are at least as stringent as the following general recommendations (see **Figure 7.7b**):

1. *Start laying the net from the top of the channel or the top of the slope and unroll downgrade.*
2. *Allow the net to lie loosely on the soil—**DO NOT STRETCH.***
3. *To secure the net, the upslope ends should be buried in a slot or trench no less than 6 inches (15 cm) deep. Tamp earth firmly over the net. Staple the net every 12 inches (30 cm) across the top end. The edges shall be stapled every 3 feet (90 cm). Where 2 strips of net are laid side by side, the adjacent edges shall be overlapped 3 inches (8 cm) and stapled together. Staples shall be placed down the center of net strips at 3 foot (90 cm) intervals. **DO NOT STRETCH** the net when applying staples.*

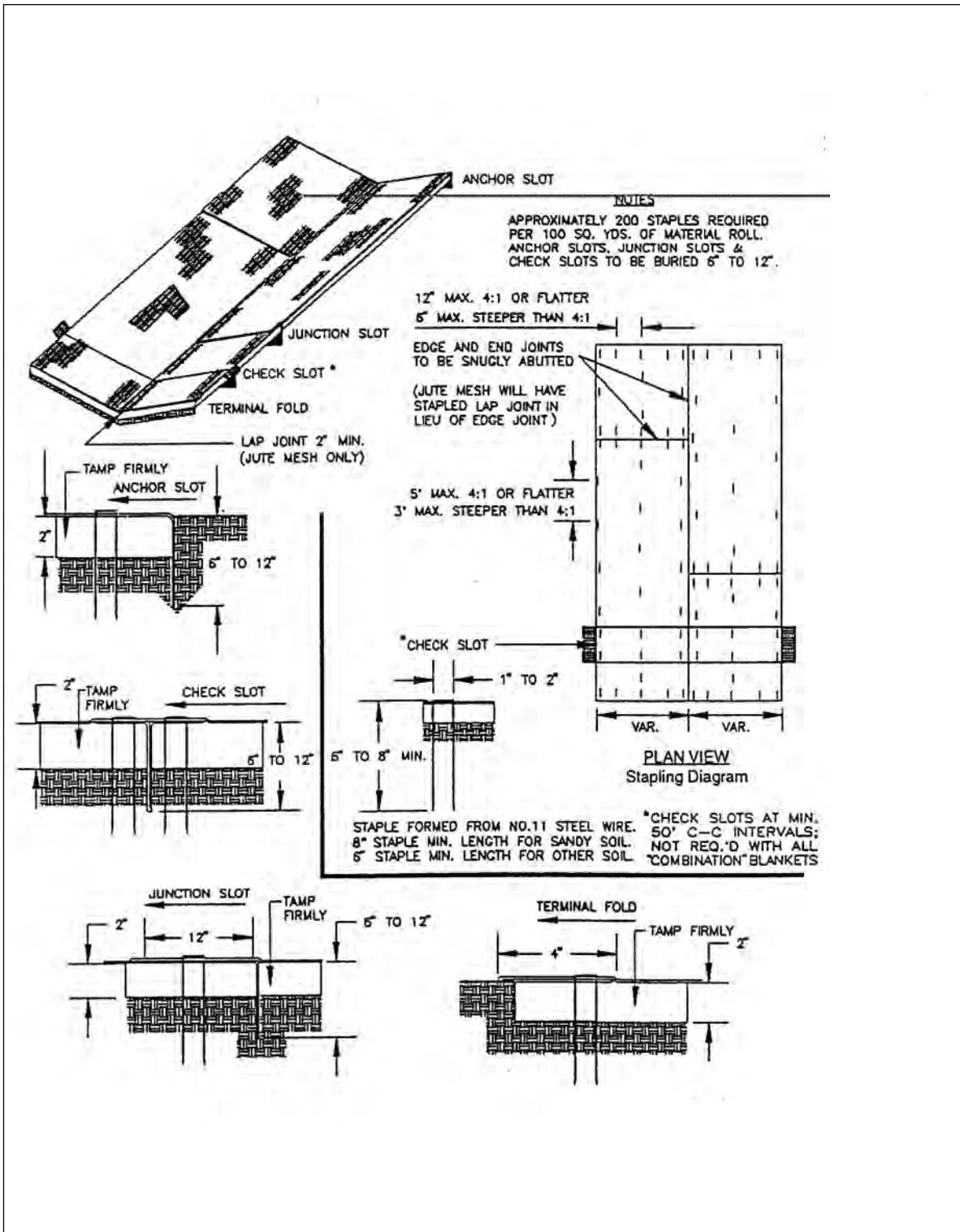

Figure 7.7b. Typical Treatment 1 – Soil Stabilization Blanket Installation Guide

Source: Virginia DOT

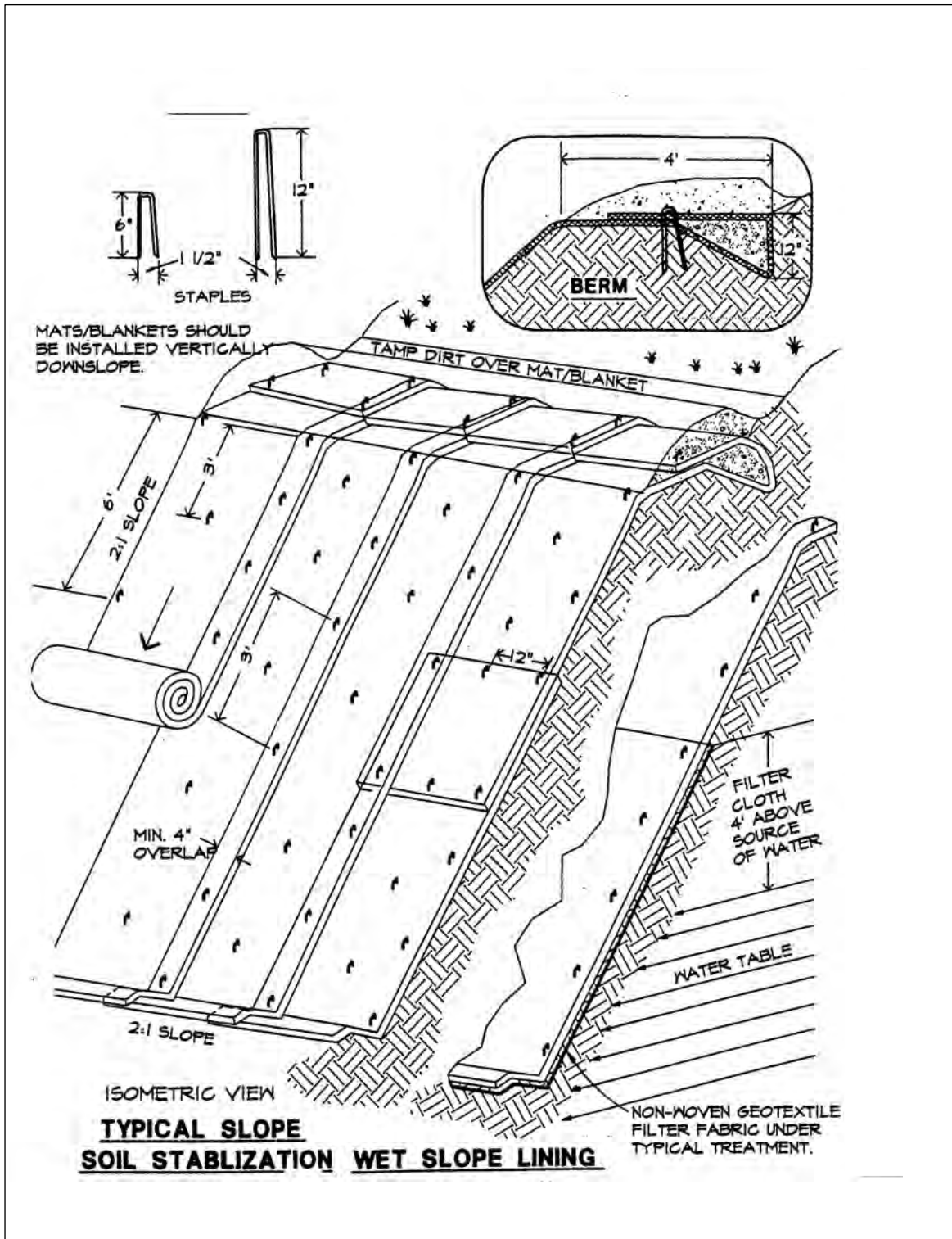

Figure 7.7c. Erosion Blankets and Turf Reinforcement Mats – Slope Installation

Source: Erosion Draw

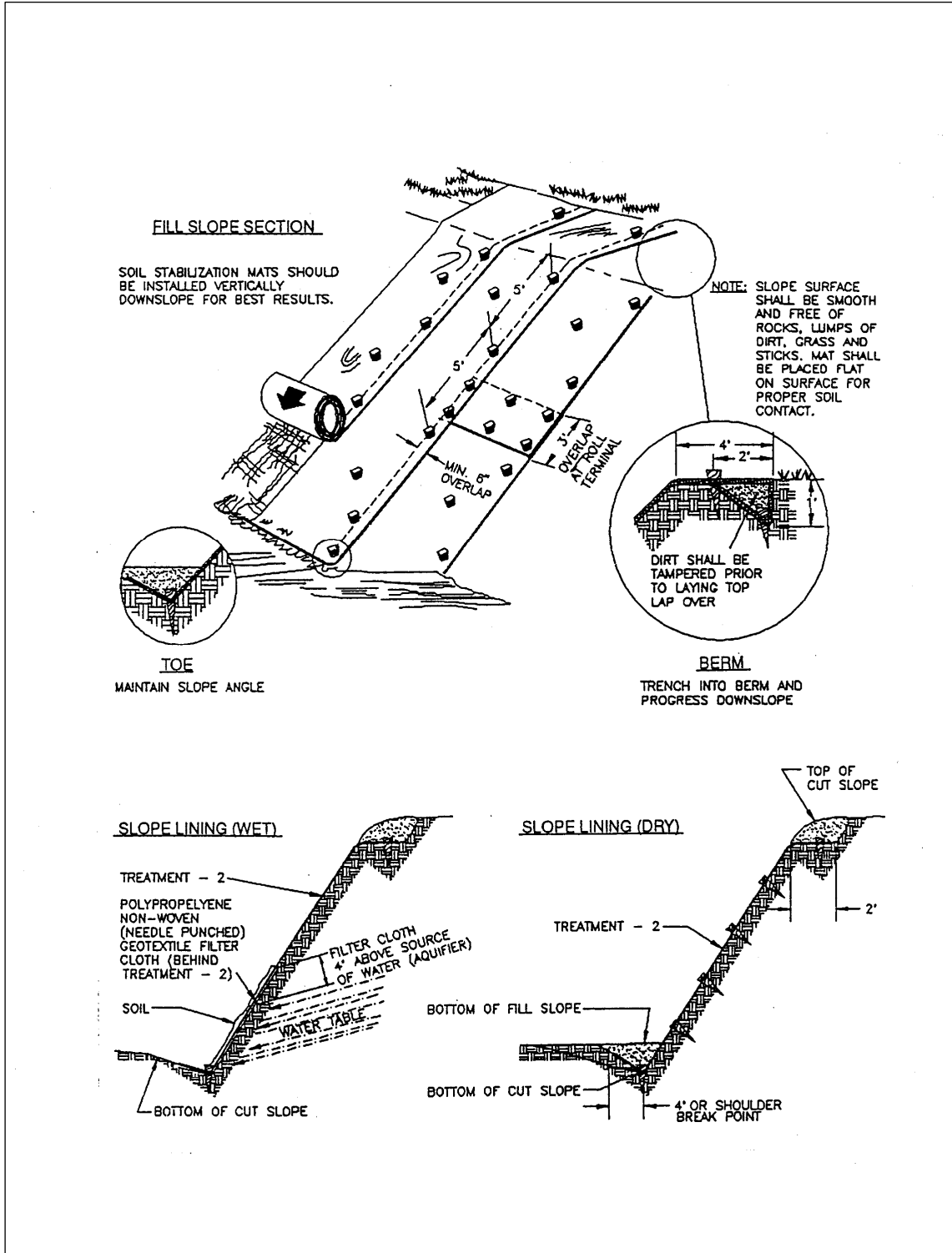

Figure 7.7d. Typical Treatment 2 – Soil Stabilization Matting Slope Installation

Source: Virginia DOT

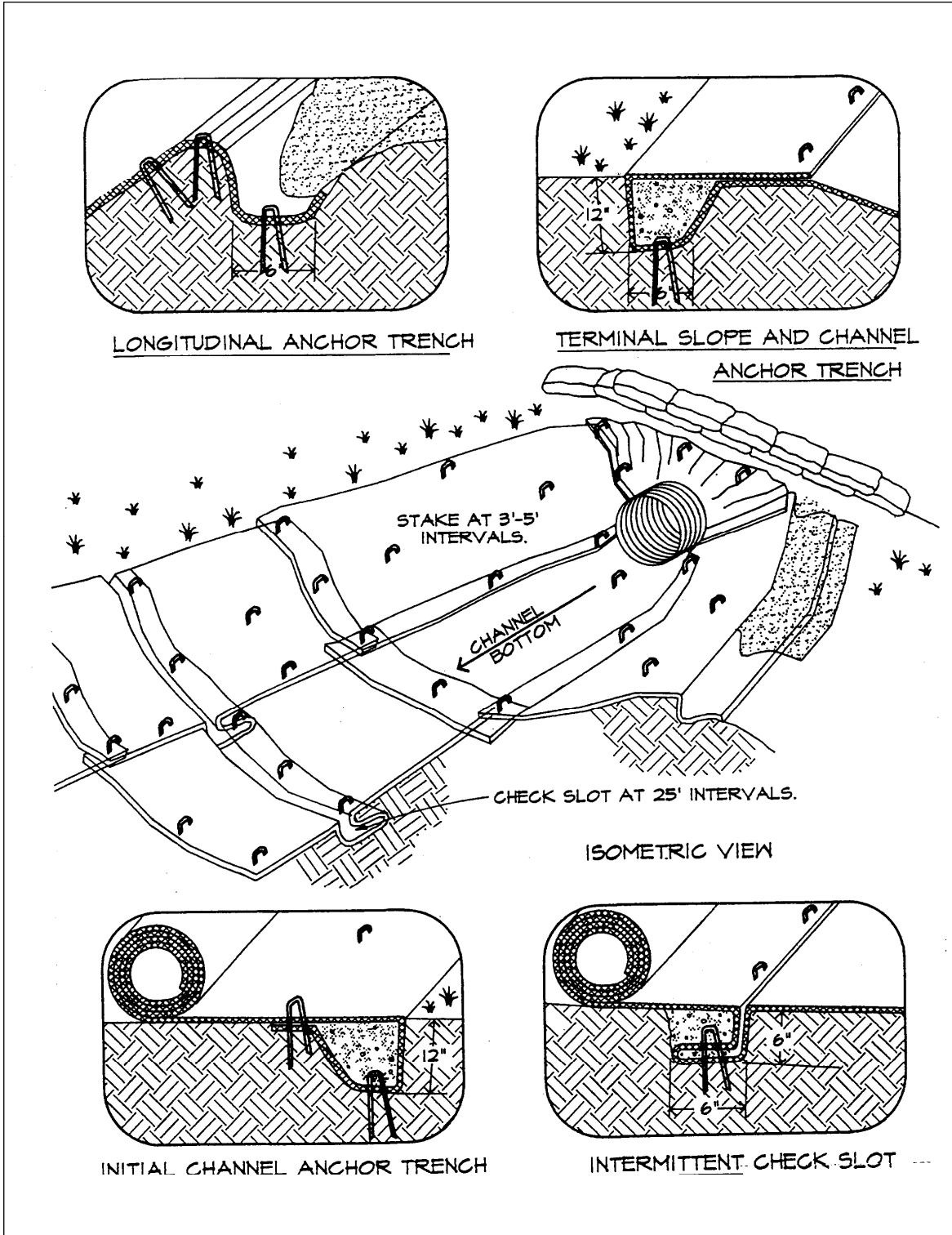

Figure 7.7e. Erosion Blankets and Turf Reinforcement Mats – Channel Installation

Source: Erosion Draw

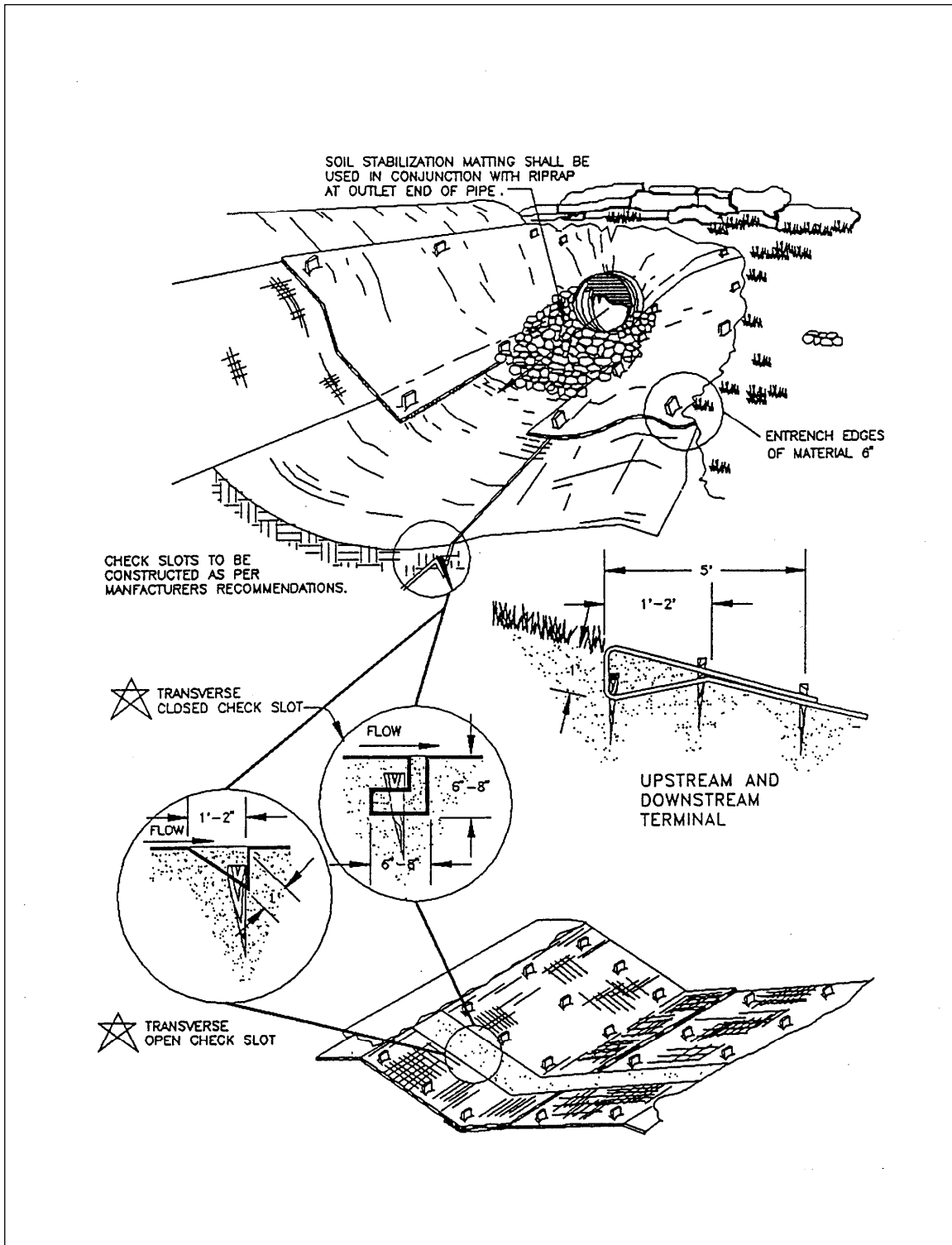

Figure 7.7f. Typical Treatment 2 – Soil Stabilization Matting Installation

Source: Virginia DOT

4. *To join strips, insert a new roll of net in the trench, as with the upslope ends of the net. Overlap the end of the previous roll 18 inches (45 cm), turn under 6 inches (15 cm), and staple across the end of the roll just below the anchor slot and at the end of the turned-under net every 12 inches (30 cm) (see **Figures 7.7g** and **7.7h**).*
5. *At the bottom of slopes, lead the net out onto a level area before anchoring. Turn the ends under 6 inches (15 cm), and staple across the ends every 12 inches (30 cm).*
6. *On highly erodible soils and on slopes steeper than 4:1, erosion check slots should be made every 15 feet (4.5 m). Insert a fold of net into a 6 inch (15 cm) trench and tamp firmly. Staple at 12 inch (30 cm) intervals across the downstream portion of the net.*
7. *After installation, stapling, and seeding, the net should be rolled to ensure firm contact between the net and soil.*

Maintenance

All mulches should be inspected periodically, particularly after rainstorms, to check for rill erosion. Where erosion is observed, additional mulch should be applied. The net should be inspected after rainstorms for dislocation or failure. If washouts or breakage occur, reinstall the net as necessary after repairing damage to the slope. Inspections should take place until the grass is firmly established. Where mulch is used in conjunction with ornamental plantings, inspect periodically throughout the year to determine if mulch is maintaining coverage of the soil surface. Repair as needed.

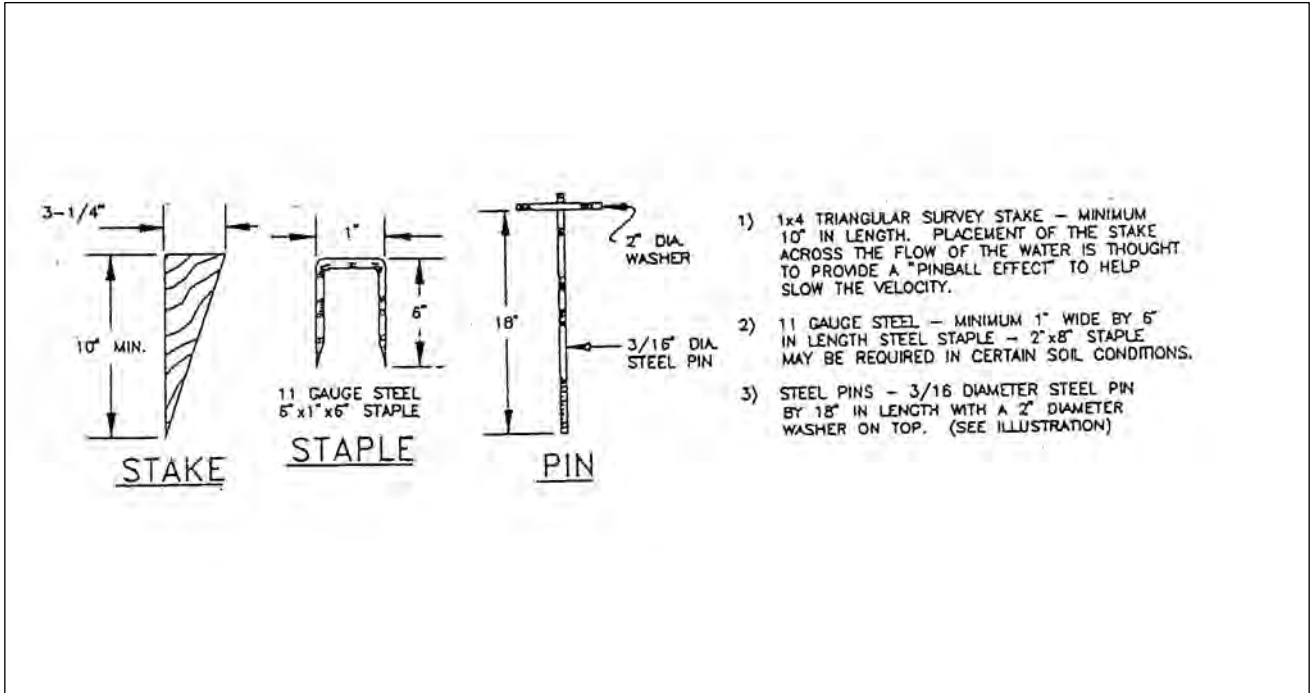

Figure 7.7g. Stakes, Staples, and Pins for the Installation of Soil Stabilization Matting

Source: Product Literature from Greenstreak, Inc.

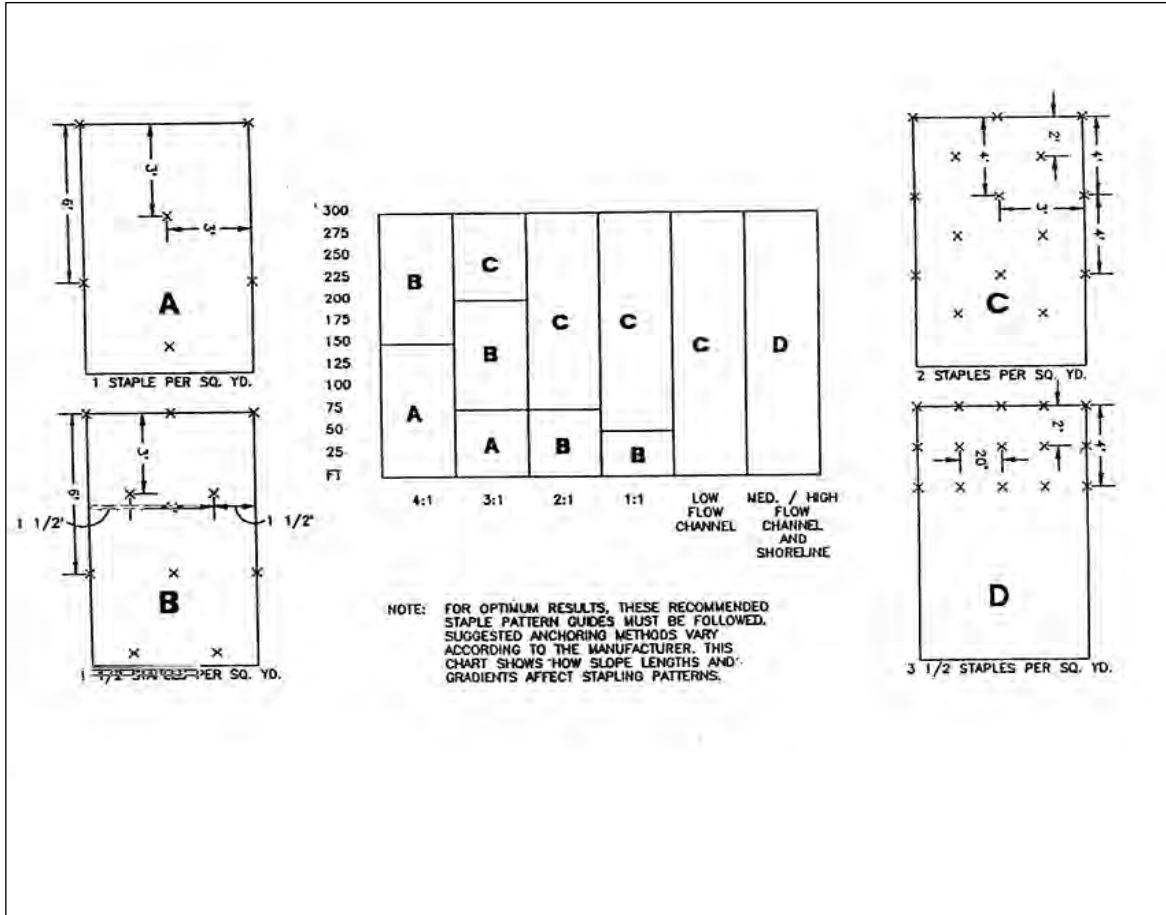

Figure 7.7h. General Staple Pattern Guide and Recommendation for Treatment 2 – Soil Stabilization Matting

Source: Product Literature from North American Green

7.8 Trees, Shrubs, Vines, and Ground Covers

Definition

Stabilize disturbed areas by establishing vegetative cover with trees, shrubs, vines, or ground covers (see **Figure 7.8a**).

Purposes

1. *To aid in stabilizing soil in areas where vegetation other than turf is preferred.*
2. *To provide food and shelter for wildlife where wildlife habitat is desirable.*

Conditions Where Practice Applies

1. *On steep or rocky slopes, where mowing is not feasible.*
2. *Where ornamentals are desirable for landscaping purposes.*
3. *In areas where turf maintenance is difficult, such as shady areas.*
4. *Where woody plants are desirable for soil conservation, or to establish wildlife habitats.*
5. *As a traffic-control measure to direct people, vehicles, and equipment to or from an area, or to control access to an area.*

Specifications

Types of Tree Plantings

1. **Bare-rooted seedlings** – *Trees to be planted as bare-rooted seedlings should be handled **only while dormant** in winter, or after leaf fall in autumn, with January being the optimum planting month (see **Figure 7.8b** for planting instructions).*

When stabilizing the disturbed areas between tree plantings, do not use grasses or legumes that will over-shade the new seedlings. Where possible, a circle of mulch around the seedlings will help them compete successfully with herbaceous plants.

2. **Transplants (balled-and-burlapped and container-grown trees)** – *Late fall through winter (November to February) is the preferred time for planting both deciduous and evergreen trees throughout Florida (see **Figure 7.8c**).*

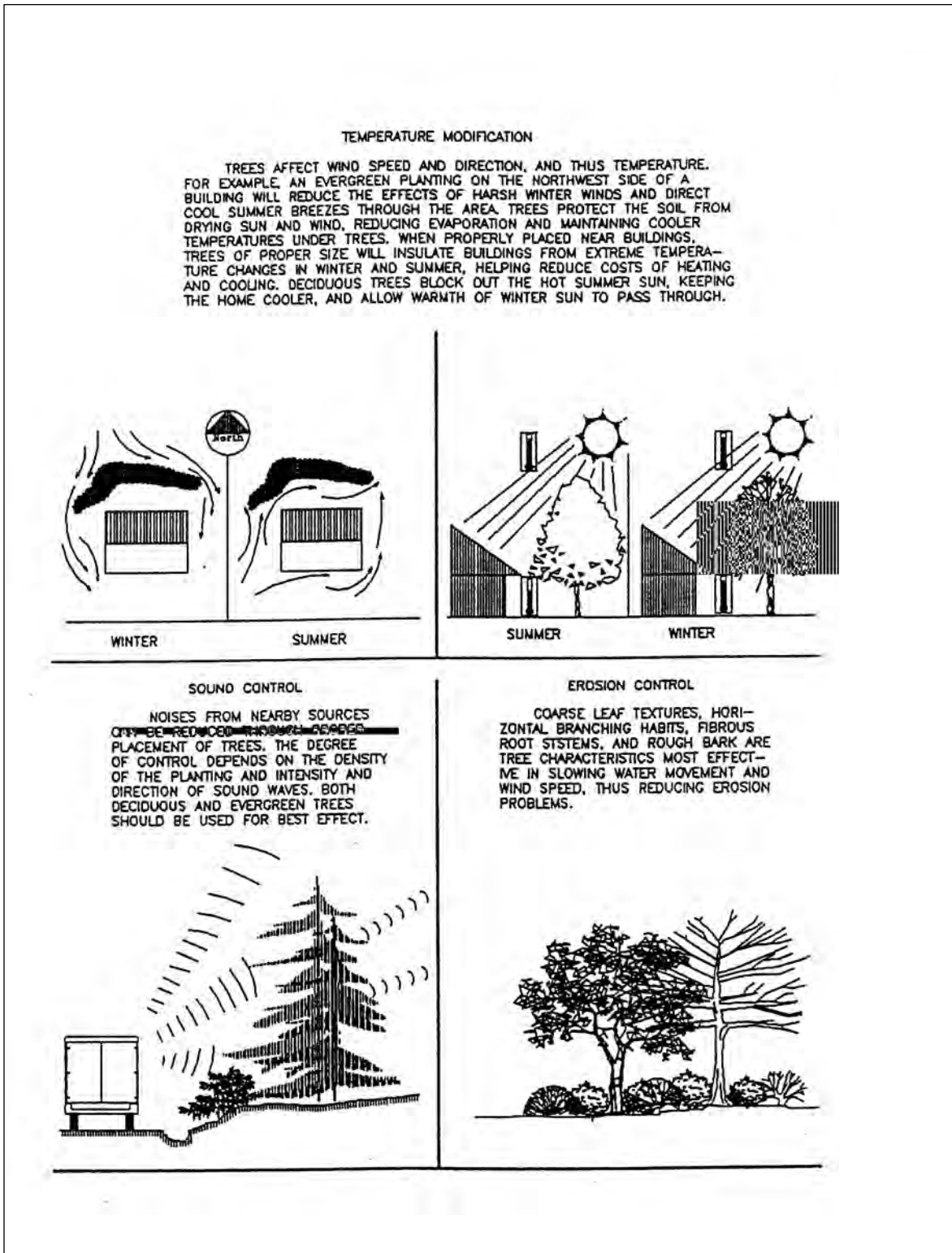

Figure 7.8a. Benefits of Trees

Source: Virginia DSWC

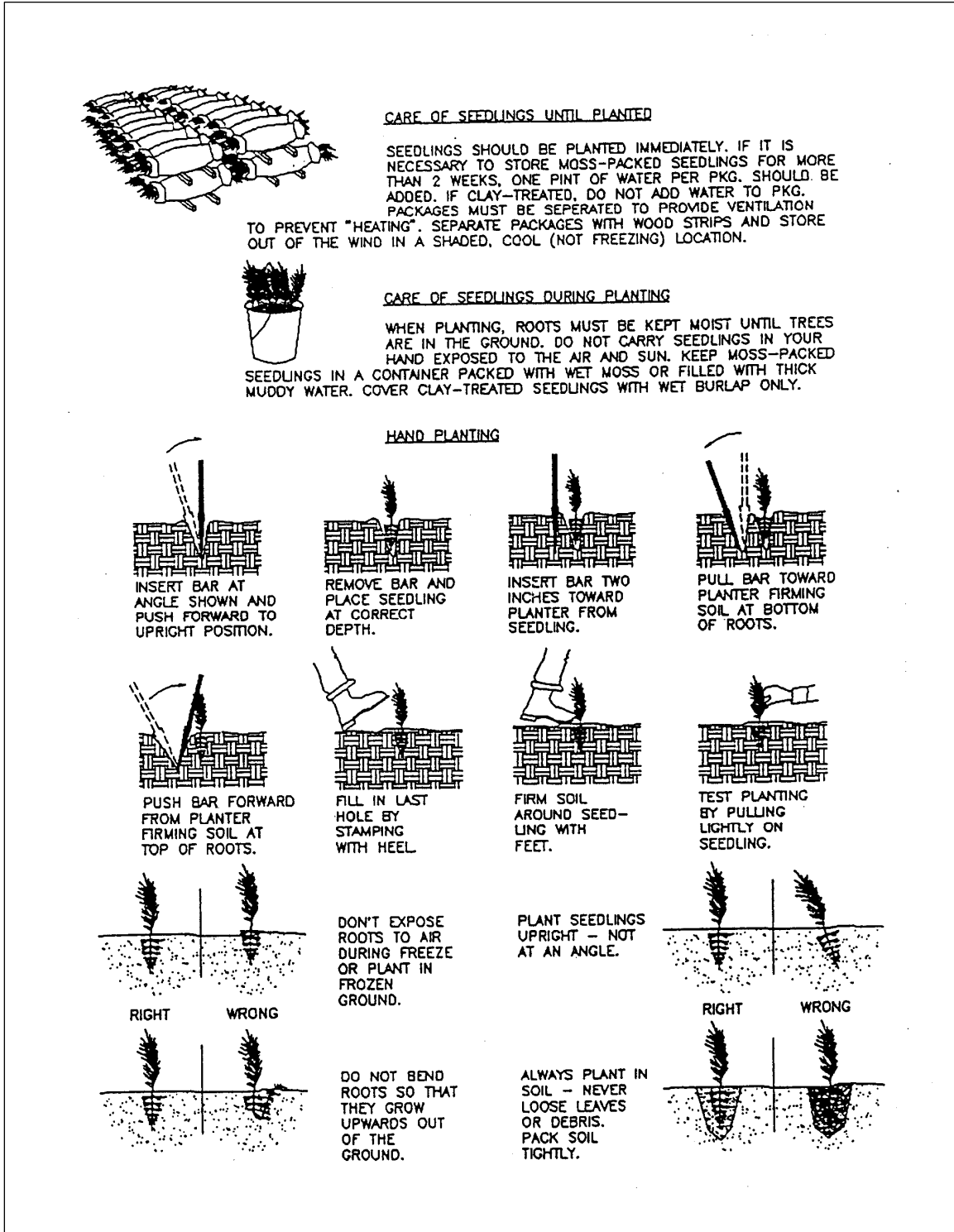

Figure 7.8b. Planting Bare Root Seedlings

Source: Virginia Department of Forestry

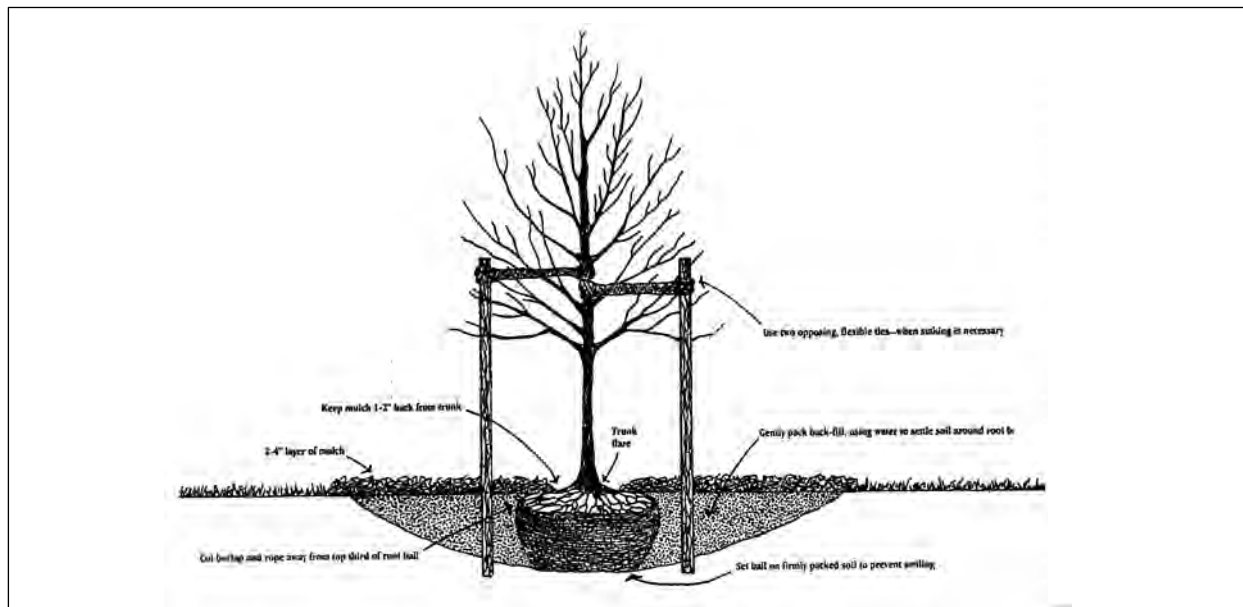

Figure 7.8c. Planting Balled-and-Burlapped and Container-Grown Trees

Source: International Society of Arbiculture

Installation

1. **Tree preparation** – In digging a tree for transplant, as much of the root system as possible should be conserved, particularly the fine roots. Soil adhering to the roots should be damp when the tree is dug and kept moist until planting. The soil ball should be 12 inches (30 cm) in diameter for each inch (2.5 cm) of diameter of the trunk. The tree should be carefully excavated and the soil ball wrapped in burlap and tied with rope. The use of a mechanical tree spade is also acceptable. Tree foliage should be protected from heat, wind, and chemical damage during transport.
2. **Site preparation** – The planting hole should be dug three times as wide as the root ball and only as deep as the root ball for proper placement of the root ball. The final level of the root ball's top should be level with the ground surface (see **Figure 7.8d**).

As the hole is dug, topsoil should be kept separate from subsoil. If possible, discard the subsoil and replace it with good topsoil. If topsoil is unavailable, improve the subsoil by mixing in one-third by volume of peat moss or well-rotted manure.

Heavy or poorly drained soils are not good growth media for trees. When it is necessary to transplant trees into such soils, extra care should be taken. Properly installed drain tile will improve drainage.

3. **Setting the tree** – The depth of planting must be close to the original depth. The tree may be set just a few inches higher than in its former location, especially if soil is poorly drained. **DO NOT** set the tree lower than before. Soil to be placed around the root ball should be moist but not wet.

Set the tree in the hole and remove the rope and the top one-third of the burlap that holds the root ball. Do not break the soil of the root ball. Fill the hole with soil halfway and tamp firmly around the root ball. Add water to settle the soil and eliminate air pockets. When the water has drained, fill the hole the remainder of the way and tamp as before.

*Use extra soil to form a shallow basin around the tree, somewhat smaller than the diameter of the root ball, to hold water when the tree is irrigated (see **Figure 7.8d**). **NOTE:** In colder climates, level the ground and eliminate these basins when winter sets in, as ice forming in the basin might injure the trunk.*

- 4. Supporting the tree** – *If the tree is grown and dug properly, staking for support is not necessary in most landscape situations. If windy conditions are a concern, trees may be supported by two stakes with wide, flexible tie straps. Stakes may also be used to protect plantings from vandalism or mower damage (see **Figure 7.8d**).*
- 5. Watering** – *The soil around the tree should be thoroughly watered after the tree is set in place. When the soil becomes dry, the tree should be watered deeply but not too often. Mulching around the base of the tree helps to prevent the roots from drying out.*

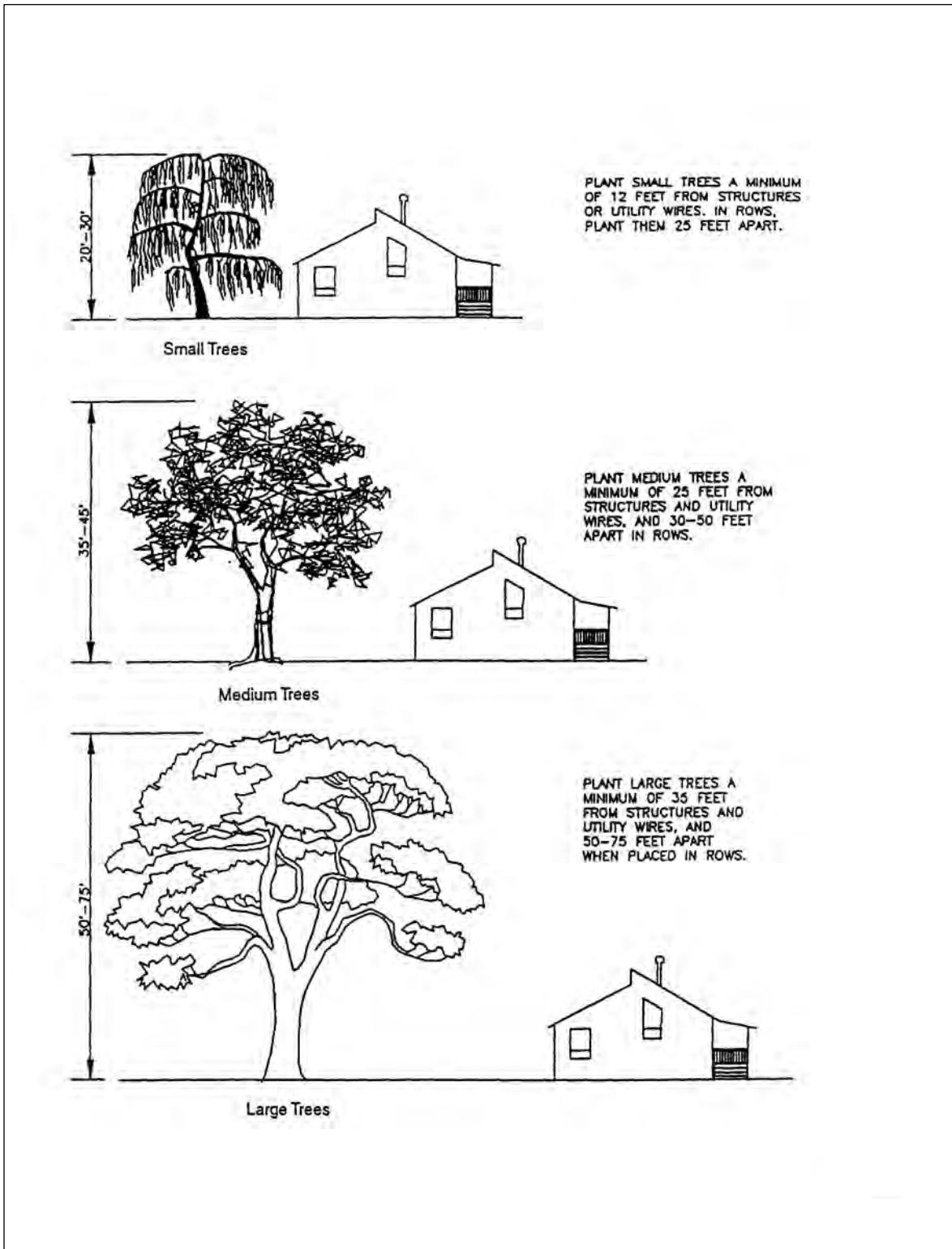

Figure 7.8d. Spacing Trees for Safety and Effective Landscaping

Source: Virginia DSWC

Maintenance

Like all plants, trees require water and fertilizer to grow. Ideally, young trees should receive an inch of water each week for the first 2 years after planting. When rain does not supply this need, the tree should be watered **deeply** but not more often than once per week.

Transplanted trees should be fertilized 1 year or so after planting. There are many sophisticated ways to supply fertilizer to trees, but some simple methods are adequate. The best material for small trees is well-rotted stable manure, if it can be obtained. Add it annually as a 2 inch (5 cm) layer of mulch around the tree. If chemical fertilizers are to be used, a formulation such as 10-8-6 or 10-6-4 is preferred. Use about 2 pounds per inch (350 grams [g]/cm) of trunk diameter measured 4 feet (1.2 m) from the ground. For example, if the trunk diameter at 4 feet (1.2 m) is 5 inches (13 cm), apply 10 pounds (4.5 kg) of fertilizer.

Fertilizer must come in contact with the roots to benefit the tree. A simple way to ensure this is to make holes in the tree's root area with a punchbar, crowbar, or auger. The holes should be 18 inches (45 cm) deep, spaced about 2 feet (60 cm) apart, and located around the drip line of the tree. Distribute the necessary fertilizer evenly into these holes, and close the holes with the heel of the shoe or by filling with topsoil or peat moss. Fertilize trees in late fall or in early spring, **before leaves emerge**.

NOTE: For evergreens, use half the recommended amount of chemical fertilizer **OR** use only organic fertilizers such as cottonseed meal, bone meal, or manure.

Planting and Maintaining Shrubs

Follow the general procedure for tree planting when planting shrubs. The proper pruning, watering, and application of fertilizer every 3 years or so will keep shrubs healthy. Maintain the mulch cover or turf cover surrounding the shrubs. A heavy layer of mulch reduces weeds and retains moisture.

Planting and Maintaining Vines and Ground Covers

Low-growing plants that sprawl, trail, spread, or send out runners come in many leaf types, colors, and growth habits. Some are suitable only as part of a maintained landscape, and some can stabilize large areas with little care. In addition to stabilizing disturbed soil, vines and ground covers can perform the following functions:

1. *Maintain cover in heavily shaded areas where turf will not thrive.*
2. *Provide attractive cover that does not need mowing.*
3. *Help to define traffic areas and control pedestrian movement. People are more likely to walk on the grass than on a thick bed of ivy or a prickly planting of juniper.*

Table 1.80c of the *Florida Development Manual* lists the characteristics of some commonly used vines and ground covers suitable for Florida. Information on others is available from nursery professionals.

Like shrubs and trees, ground covers are best planted in spring. Container-grown plants can be planted throughout the growing season if adequate water is provided.

Site Preparation

Ground covers naturally grow very close together, competing for space, nutrients, and water. Thus soil for planting ground covers should be well-prepared. A well-drained soil high in organic matter is best. The entire area should be spaded, disced, or rototilled to a depth of 6 to 8 inches. Two to 3 inches of organic material, such as good topsoil, peat, or well-composted manure, should be spread over the entire area. Apply 9 to 18 pounds per 1,000 square feet (440 to 880 kg/ha) of 10-10-10 fertilizer and incorporate the organic material and fertilizer into the soil before planting.

If the area to be planted is very large or it is impractical to prepare the entire area, individual planting holes one-third larger and deeper than the plant root ball should be dug. If the soil is not suitable for plant growth, it is best to batch blend a planting medium. A good mixture consists of 1:1 or 2:1 sandy loam soil and peat, composted manure, or other well-rotted organic material with 10 pounds of 10-10-10 fertilizer and 20 pounds of lime per cubic yard (6 kg/m³ fertilizer and 12 kg/m³ lime) of soil mix. Lime should not be used for acid-loving plants such as camellias, azaleas, or blueberries.

Planting

Plants such as ivy, pachysandra, and periwinkle should be planted on 1 foot centers; large plants such as juniper can be spaced on 3 foot (90 cm) centers. The following steps will help ensure good plant growth:

- 1. Make the plantings on the contour.*
- 2. Dig the holes one-third larger than the plant root ball.*
- 3. Plant at the same level that the plants grew.*
- 4. Use good topsoil or soil mixture with a lot of organics.*
- 5. Fill the hole one-third to one-half full, shake the plants to settle soil among the roots, and then water. Finish filling the hole, firm slightly, and again settle with water.*
- 6. Leave a saucer-shaped depression around the plant to hold water.*
- 7. Water thoroughly and regularly.*
- 8. Space plants according to the type of plant and the extent of covering desired. Set small plants as close as 4 to 6 inches (10 to 15 cm) apart and large plants as much as 4 feet (1.2 m) apart. The following table shows the area that approximately 100 plants will cover when set at various distances apart:*

Planting Distance (inches)	Area Covered (square feet)
4	11
6	25
8	44
10	70
12	120
18	225
24	400
36	900
48	1,600

Mulching

The soil between trees and shrubs must be planted with cover vegetation or mulched. When establishing ground covers, it is not desirable to plant species that will compete strongly with the ground cover or will make maintenance difficult. A thick, durable mulch such as shredded bark or wood chips is recommended to prevent erosion and reduce weed problems. Pre-emergent herbicides may be necessary where weeding is not practical.

On slopes where erosion may be a problem, jute net or excelsior blankets may be installed prior to planting, and the plants tucked into the soil through slits in the net. Such plants should be put in a staggered pattern to minimize erosion.

Maintenance

Trim old growth as needed to improve the appearance of ground covers. Most need once-a-year trimming to promote growth. Maintain mulch cover by adding mulch where needed. Fertilize as described above every 3 to 4 years.

7.9 Tree Preservation and Protection

Definition

The protection of desirable trees from mechanical and other injury during land-disturbing and construction activities

Purpose

To ensure the survival of desirable trees where they will be effective for erosion and sediment control, watershed protection, landscape beautification, dust and pollution control, noise reduction, shade, and other environmental benefits while the land is being converted from forest to urban-type uses or being redeveloped.

Conditions Where Practice Applies

Tree-inhabited areas subject to land-disturbing activities.

Specifications

1. **Identification and Retention** – *Groups of trees and individual trees selected for retention shall be accurately located on the plan and designated as "tree(s) to be saved." Individual specimens that are not part of a tree group shall also have their species and diameter noted on the plan.*
2. **Critical Root Zone (CRZ)** – *A CRZ should be identified for each tree or group of trees to be saved. A CRZ takes into account the root area needed to preserve the tree. Due to their key role in supplying the tree with water, nutrients, and support, roots must be protected to ensure tree health after construction. Contrary to popular belief, a tree's roots extend far beyond the drip line, occupying from 2 to 10 times the area of the canopy.⁷ In addition, tree roots typically grow very shallowly, mostly in the upper 3 feet of soil.⁸ Because the size of a tree's drip line can be highly variable, the CRZ method uses the diameter of the trunk to determine the area of roots required to preserve a tree. Calculating the CRZ is simple: 1 foot from the trunk (in each direction) for each inch of the diameter of the tree (measured approximately at chest height)⁹ (see **Figure 7.9a**).*
3. **Limits of Disturbance (LOD)** – *The LOD should be located outside the CRZ of any tree to be retained, encroaching on no more than one-third of the CRZ¹⁰ for any tree to be saved and no closer than 8 feet to the trunk of these trees (see **Figure 7.9a**). (Exceptions can be made for palms, which benefit from the typical CRZ but can tolerate disturbance to 90% or more of their root zone and allow impacts to within 2 feet of the trunk.)¹¹ If the limits of clearing will impact more than one-third of the CRZ or come closer*

⁷ Matheny and Clark, 1998. p. 16.

⁸ Harris, Clark, and Matheny, 1999, p. 36.

⁹ Matheny and Clark, 1998, p. 74.

¹⁰ Matheny and Clark, 1998.

¹¹ <http://hort.ifas.ufl.edu/woody/palms.html>.

than 8 feet to any given tree, the tree should be removed unless otherwise directed by a Certified Arborist or other tree care professional. The edge of the CRZ for all trees to be retained, adjusted as necessary so it does not overlap with the LOD, is referred to as the tree conservation area (TCA).

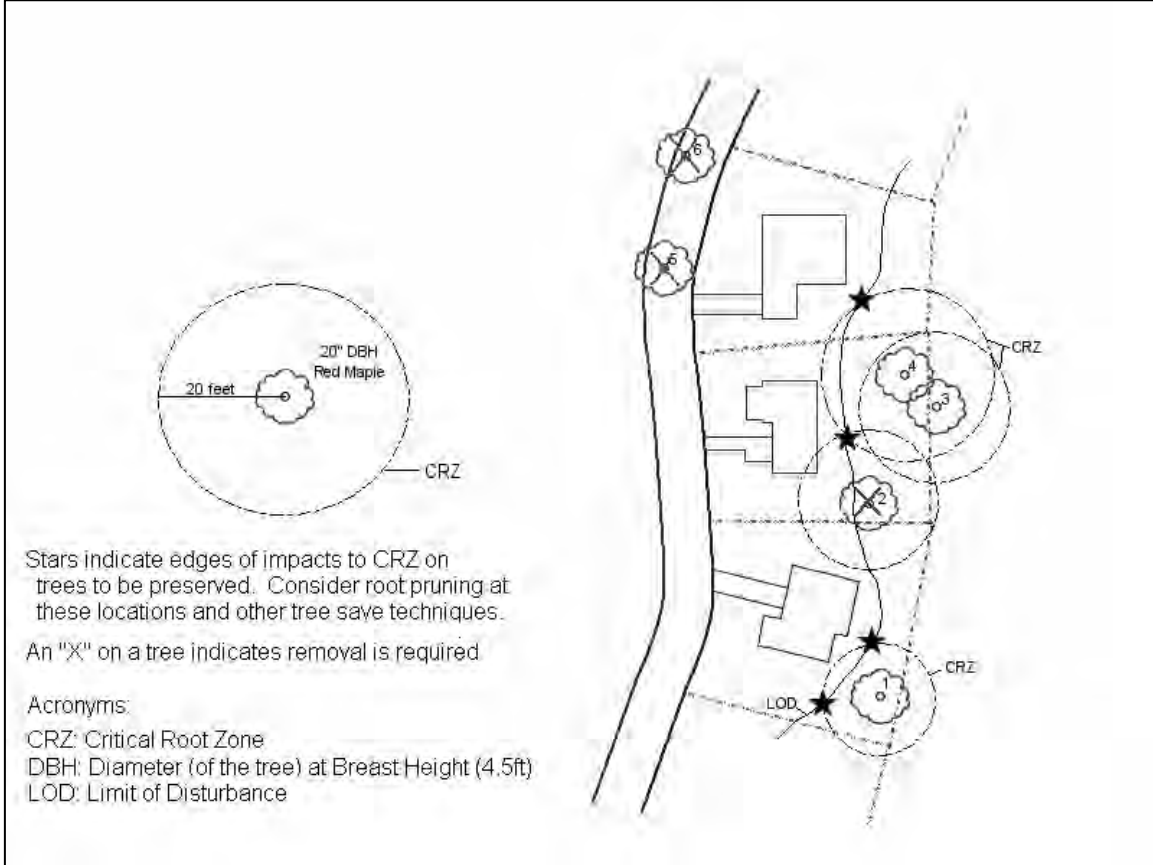

Figure 7.9a. Determining the CRZ and TCA

FDEP, 2006 . The left side of the figure depicts a CRZ for an individual tree, calculated by establishing 1 foot in radius for each inch in diameter of the tree at diameter breast height (DBH), which corresponds to 4.5 feet above the ground.

In the example on the right, Trees 1, 3, and 4 have CRZs that can largely be preserved during development; therefore, the CRZ that remains outside the LOD is designated as a TCA. The stars designate the starting and stopping points for root pruning and protective fencing. (Protective fencing should be extended farther if construction equipment could approach the tree from the sides or the back of the lot.)

Tree 2 is outside the LOD, but will have greater than 30% of its CRZ impacted by the development. Therefore this tree needs to be removed even though it is outside the LOD, so it does not become a hazard. Trees 5 and 6 are within the LOD and will be removed.

4. **Marking** – Before construction and before the preconstruction conference, the TCA shall be visibly marked with stakes, ribbon, pin flags, or similar means. The limits of the TCA will correspond to the LOD in that area. Any trees within the TCA (outside the LOD) that are to be removed due to poor health or close proximity to the LOD should be marked with paint or flagging.
5. **Preconstruction Conference** – During any preconstruction conference, tree preservation and protection measures, including the location of the TCA and any trees that are within it that have to be removed. The CRZ should be reviewed with the contractor as it applies to that specific project.
6. **Root Pruning** – After the TCA has been agreed on at the preconstruction conference, the perimeter of the TCA shall be root pruned with a vibratory plow or similar device (**Figure 7.9b**). If a trencher is used for root pruning, all cut roots 1 inch and greater in diameter must then be hand pruned to ensure smooth cuts. Root pruning prevents crushing or other damage to roots in the construction zone, giving the trees to be retained the best chances for survival.
7. **Equipment Operation and Storage** – Heavy equipment, vehicular traffic, or stockpiles of any construction material, including topsoil, shall not be permitted in the TCA. Trees being removed shall not be felled, pushed, or pulled into trees being retained. Equipment operators shall not clean any part of their equipment by slamming it against the trunks of trees to be retained.
8. **Fires** – Fires shall not be permitted within 100 feet (30 m) from the drip line of any trees to be retained. Fires shall be limited in size to prevent adverse effects on trees, and kept under surveillance.
9. **Storage and Disposal of Toxic Materials** – No toxic materials shall be stored closer than 100 feet (30 m) to the drip line of any trees to be retained. Paint, acid, nails, gypsum board, wire, chemicals, fuels, and lubricants shall not be disposed of so as to injure vegetation.
10. **Fencing and Armoring (Figure 7.9b)** – Any device may be used that will effectively protect the roots, trunk, and tops of trees retained onsite. However, trees to be retained within 40 feet (12 m) of a proposed building or excavation shall be protected by fencing. Personnel must be instructed to honor protective devices. The following devices are only suggestions and are not intended to exclude the use of other devices that will protect the trees to be retained:
 - a. **Orange Construction Fence** – Standard 48 inch (1.2 m) high fence to be placed at the limits of the clearing/TCA line on standard steel posts set 6 feet (1.8 m) apart.
 - b. **Board Fence** – Board fencing consisting of 4 inch (10 cm) square posts set securely in the ground and protruding at least 4 feet (1.2 m) above the ground shall be placed at the limits of clearing with a minimum of 2 horizontal boards between posts.

- c. **3-Strand Wire Fence** – Posts with a minimum size of 2 inches (5 cm) square or 2 inches (5 cm) in diameter set securely in the ground and protruding at least 4 feet (1.2 m) above the ground, with 3 rows of wire with strips of colored surveyor's flagging tied securely to the string at intervals no greater than 3 feet (90 cm).

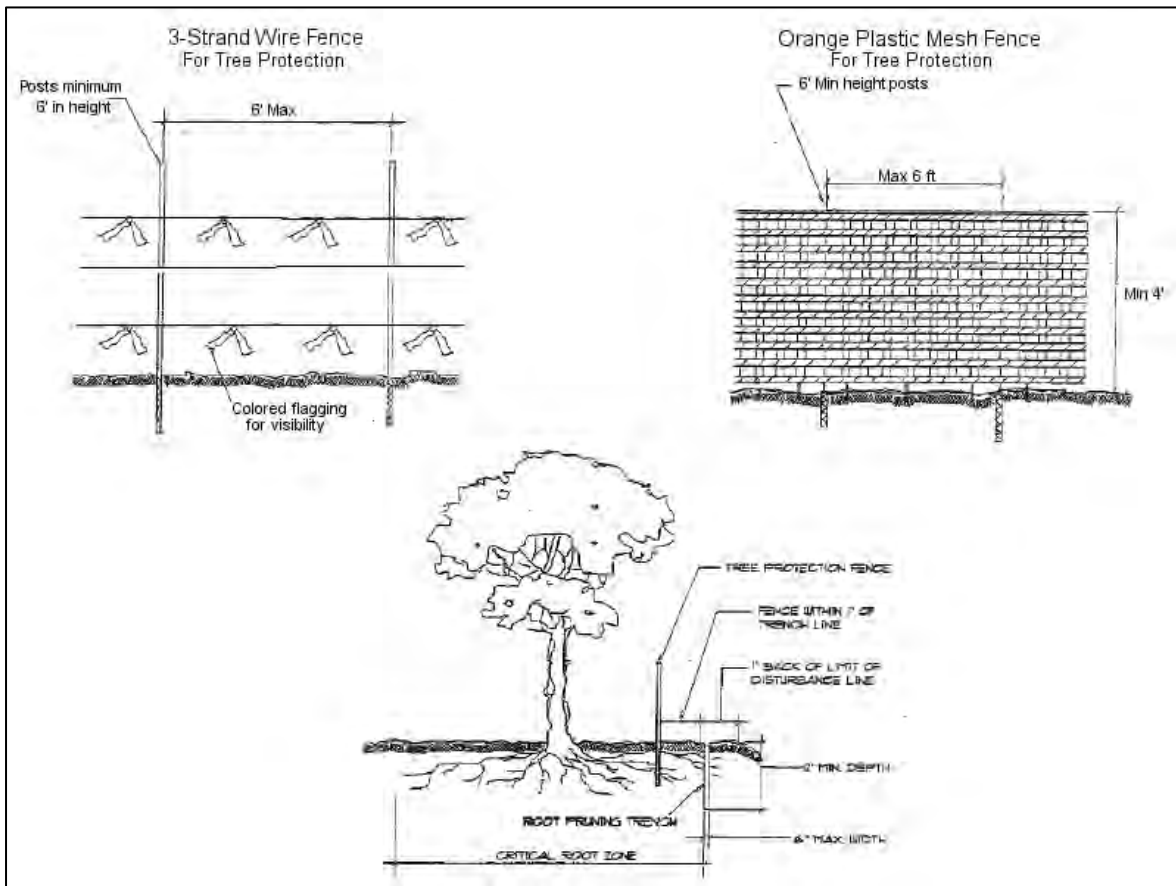

Figure 7.9b. Tree Conservation Area Protection Practices

Source: Montgomery County, Maryland, 1992

- d. **Earth Berms** – Temporary earth berms shall be constructed according to the specifications for a **Temporary Diversion Berm** (under **PERIMETER CONTROLS** in **Chapter 4**), with the base of the berm on the tree side located along the limits of clearing. Earth berms may not be used for this purpose if their presence conflicts with drainage patterns.
- e. **Additional Trees** – Additional trees may be left standing as protection between the trunks of the trees to be retained and the limits of clearing. However, for this alternative to be used, the trunks of the trees in the buffer must be no more than 6 feet (1.8 m) apart to prevent equipment and material from passing through the buffer. These additional trees shall be re-examined prior to the completion of construction and either given sufficient treatment to ensure survival or removed.
- f. **Trunk Armoring** – A tree trunk can be armored with burlap wrapping and 2 inch (5 cm) studs wired vertically no more than 2 inches (5 cm) apart to a minimum height of 5 feet (1.5 m) encircling the trunk. This alternative should only be used in situations where heavy machinery will be working close to a tree to be retained. If this method of protection is used, the CRZ will still require protection. Do not nail trunk armoring to a tree. Fencing and armoring devices and any other tree protection measures shall be in place before any site clearing, excavation, or grading begins, shall be kept in good repair for the duration of construction activities, and shall be the last items removed during the final cleanup after the completion of the project.

11. Trenching and Tunneling (see Figure 7.9c):

- a. Trenching shall be done as far away from the trunks of trees as possible, preferably outside the branches or crown spreads of trees, to reduce the amount of root area damaged or killed by trenching activities.
- b. Wherever possible, trenches should avoid large roots or root concentrations. This can be accomplished by curving the trench or by tunneling under large roots and areas of heavy root concentration.
- c. Tunneling under an individual specimen that does not have a large taproot may be preferable to trenching beside it. Tunneling is more expensive initially, but it usually causes less soil disturbance and physiological impact on the root system. The extra cost may offset the potential costs of tree removal and replacement should the tree die.
- d. When trenching, the roots in the trench shall not be left exposed to the air. They shall be covered with soil as soon as possible or protected and kept moistened with wet burlap or peat moss until the trench or tunnel can be filled.

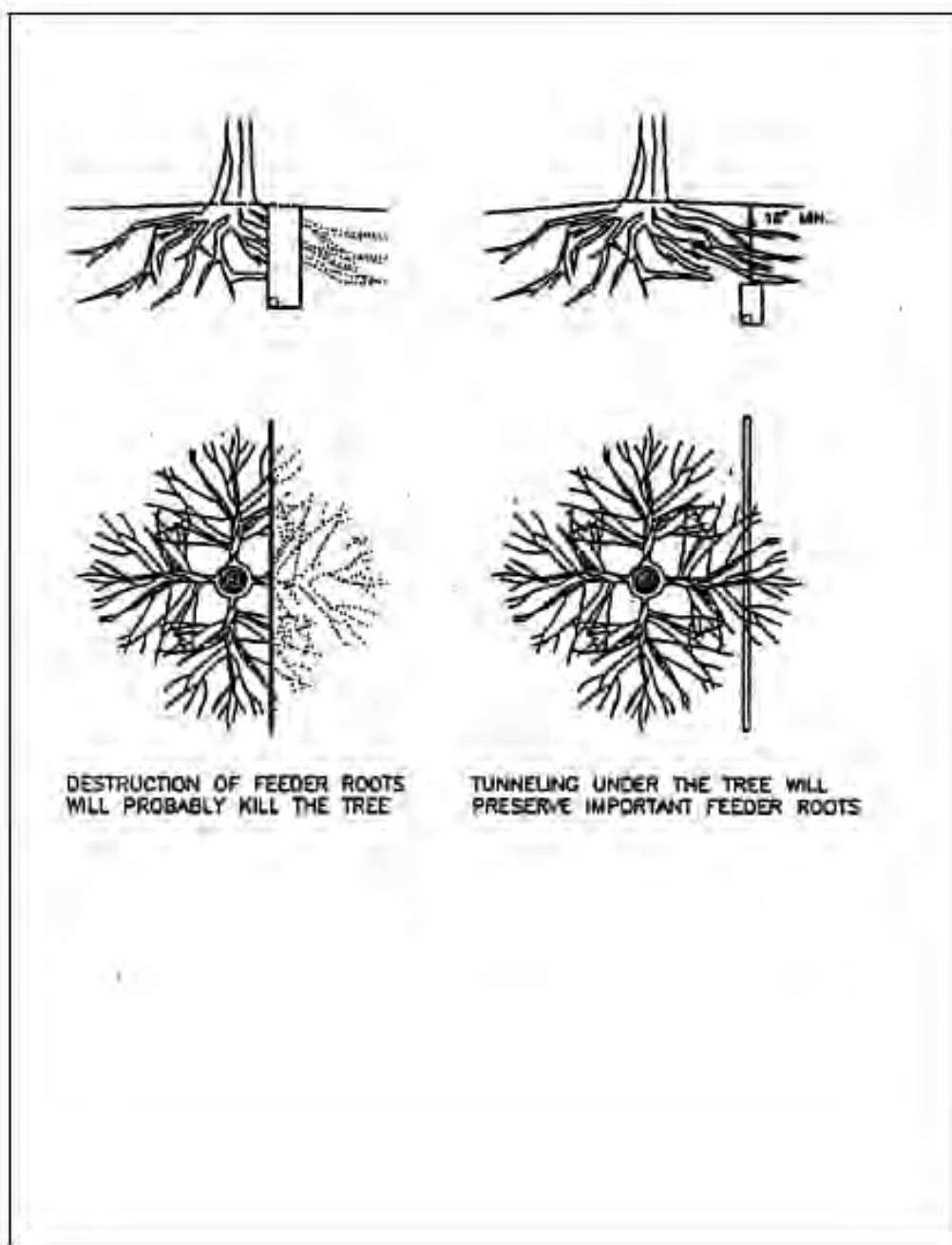

Figure 7.9c. Trenching vs. Tunneling

Source: Pirone, 1979

- e. Inside the trench, the ends of damaged and cut roots shall be cut off smoothly with pruning shears or a chainsaw.¹²
 - f. Trenches and tunnels shall be filled as soon as possible. Air spaces in the soil shall be avoided by careful filling and tamping.
 - g. Peat moss or other suitable material shall be added to the fill material as an aid to inducing and developing new root growth.
 - h. The tree shall have mulch placed on top of the CRZ to the extent practical to conserve moisture and prevent competition from herbaceous plants.
 - i. If a large amount of the root system has been damaged or killed, an irrigation plan shall be implemented to ensure the tree receives adequate water. Irrigation should occur weekly and should be substantial enough to wet the top 2 feet of soil in the CRZ or the amount equivalent to a 1 inch rain event.¹³
12. **Removal and Replacement of Damaged Trees** – *If a tree is identified and marked to be retained, but is damaged seriously enough that survival and normal growth are impossible, it shall be removed. If replacement is desirable and/or required, the replacement tree shall be of the same or a similar species, 2 to 2½ inch (5 to 6 cm) caliper balled-and-burlapped nursery stock.*
13. **Cleanup** – *Cleanup after a construction project can be a critical time for tree damage. Trees protected throughout the development operation are often destroyed by carelessness during the final cleanup and landscaping. Fences and barriers shall be removed last, after everything else is cleaned up and carried away.*
14. **Maintenance** – *In spite of precautions, some damage to protected trees may occur. In such cases, the following guidelines should be followed:*
- a. **Irrigation** – *Damage to trees or tree roots is often accompanied by a reduced ability to obtain needed water. The implementation of an irrigation plan for damaged trees, including trees with significant pruning or root loss, will help to ensure the trees' survival. Irrigation should occur weekly and should be substantial enough to wet the top 2 feet of soil in the CRZ or the amount equivalent to a 1 inch rain event.¹⁴*
 - b. **Repairing Damage** –
 - i. *Any damage to the crown, trunk, or root system with the TCA of any tree retained on the site shall be repaired immediately.*
 - ii. *A Certified Arborist or equivalent landscape professional shall perform or oversee all tree repair activities.*
 - iii. *Damaged roots shall immediately be cut off cleanly inside the exposed or damaged area. Moist peat moss, burlap, or topsoil shall be spread over the exposed area.*

¹²Pruning shears or chainsaw are specified because construction personnel may otherwise opt to use ditching or other equipment, which tears rather than cuts. Torn roots create a healing problem and are a source of pathogens for trees. American National Standards Institute (ANSI) A300 Best Management Practices – Tree Pruning, p. 24 – "Wound dressings are used primarily for cosmetic purposes, and neither are required nor recommended in most cases."

¹³<http://hort.ifas.ufl.edu/woody/maintenance.html>.

¹⁴<http://hort.ifas.ufl.edu/woody/maintenance.html>.

- iv. *If the bark of a tree branch appears to be substantially damaged, prune the branch back to the collar. If the bark of the trunk appears to be substantially damaged, leave the remaining bark intact and contact a Certified Arborist for advice on treating the injury.*
- v. *All tree limbs damaged during construction or removed for any reason shall be cut off above the collar at the preceding branch junction (see **Figure 7.9d**).*
- vi. *Care for serious injuries shall be prescribed by a Certified Arborist or other tree care specialist.*

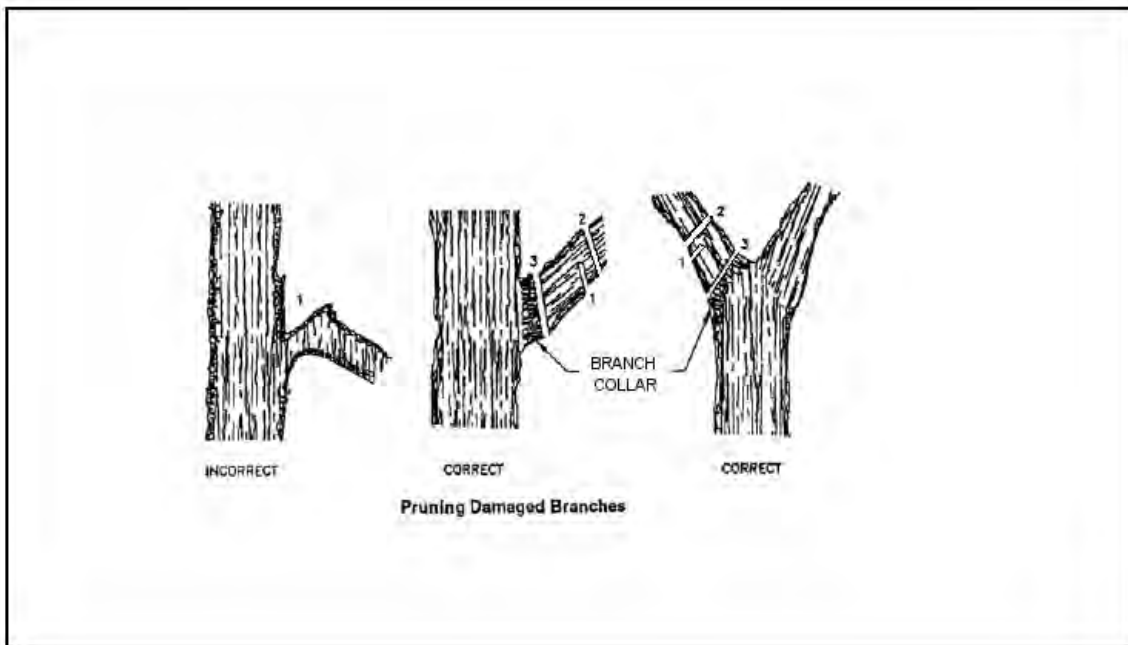

Figure 7.9d. Proper Pruning Technique

FDEP, 2006

7.10 Vegetative Streambank Stabilization

Definition

The use of vegetation in stabilizing streambanks.

Purpose

To protect streambanks from the erosive forces of flowing water.

Conditions Where Practice Applies

Along banks in creeks, streams, and rivers subject to erosion from excess runoff. This practice is generally applicable where bank-full flow velocity does not exceed 5 feet per second (1.5 m/sec) and soils are erosion resistant. Above 5 feet per second (1.5 m/sec), structural measures are generally required. This practice does not apply where tidal conditions are present.

Planning Considerations

A primary cause of stream channel erosion is the increased frequency of bank-full flows, often resulting from upstream development. Most natural stream channels are formed with a bank-full capacity to pass the runoff from a storm with a 1½ to 2 year recurrence interval. In a typical urbanizing watershed, however, stream channels are subject to a three to fivefold increase in the frequency of bank-full flows. As a result, stream channels that were once parabolic in shape, with their banks covered with vegetation, are transformed into wide channels with barren banks.

In recent years, a number of structural measures have evolved to strengthen and protect the banks of rivers and streams. These methods, if employed correctly, immediately ensure satisfactory protection for the banks. However, many such structures are expensive to build and maintain, and frequently contribute to downstream velocity problems. Without constant upkeep, they are exposed to progressive deterioration by natural agents. The materials used often prevent the re-establishment of native plants and animals, especially when the design is executed according to standard cross-sections, which ignore the natural variation of a stream system. Very often these structural measures diminish the appearance of a site.

In contrast, the use of living plants in conjunction with structures has many advantages. The degree of protection, which may be low to start with, increases as the plants grow and spread. The repair and maintenance of structures is unnecessary where self-maintaining streambank plants are established. The protection provided by natural vegetation is more reliable and effective where the cover consists of natural plant communities that are native to the site. Planting vegetation is less damaging to the environment than installing structures. Vegetation also provides a habitat for fish and wildlife and is aesthetically pleasing. Plants provide erosion protection to streambanks by absorbing stream velocity, binding soil in place with a root mat, and covering the soil surface when high flows tend to flatten vegetation against the banks. For these reasons, vegetation should always be considered first.

One disadvantage of streambank vegetation is that it lowers the carrying capacity of the channel and may promote flooding. Therefore, maintenance needs and the consequences of flooding should be considered. The erosion potential for the stream needs to be evaluated to determine the best solutions. The following items should be considered in the evaluation:

1. *The frequency of bank-full flow based on anticipated watershed development.*
2. *The channel slope and flow velocity, by design reaches.*
3. *The antecedent soil conditions.*
4. *Present and anticipated channel roughness ("n") values.*
5. *The location of channel bends along with bank conditions.*
6. *The location of unstable areas and trouble spots. Steep channel reaches, high erosive banks, and sharp bends may require structural stabilization measures such as riprap, while the remainder of the streambank may require only vegetation.*

Where streambank stabilization is required and velocities appear too high for the use of vegetation, one should consider structural measures or the use of permanent erosion control matting, as in **MULCHING** (in this chapter). **NOTE: Any applicable approvals or permits from other state or federal agencies must be obtained prior to working in such areas.**

Vegetation Zones along Watercourses

At the edges of all natural watercourses, plant communities exist in a characteristic succession of vegetative zones, the boundaries of which depend on site conditions such as the steepness and shape of the bank and the seasonal and local variation in water depth and flow rate. Streambanks commonly exhibit the following zonation (see **Figure 7.10a**):

- **Zone 1: Aquatic Plant Zone** – *This zone, which is normally permanently flooded, is inhabited by plants such as alligator weed, hydrilla, parrotfeather, and water lilies. These reduce the water's flow rate by friction. The plants' roots help bind the soil and protect the channel from erosion, because the water flow tends to flatten them against the banks.*
- **Zone 2: Herbaceous Flooded Zone** – *The lower part of this zone is normally flooded for only about half the year. In Florida, this zone is inhabited by rushes, sedges, pickerel weed, smartweeds, cattails, and other plants that bind the soil with their roots, rhizomes, and shoots and slow the water by friction.*
- **Zone 3: Shrub Zone** – *This zone is flooded only during periods of average high water. In Florida, it is inhabited by trees and shrubs with a high regenerative capacity, such as willow, red maple, button-bush, and sweet bay. These plants hold the soil with their root systems and slow the water by friction. They prevent the formation of strong eddies around large trees during flood flows. Woody zone vegetation is particularly beneficial along the impact bank of a stream meander, where maximum scouring tends to occur.*

The infringement of shrub vegetation into the channel reduces the channel width, increasing the probability of floods.

- Zone 4: Tree Zone Infrequently Flooded** – This zone is flooded only during periods of very high water (i.e., the 2 year bank-full flow or greater flows). Typical trees in this zone in Florida are in the oak family. They hold soil in place with their root systems. However, the brief flooding of riverside woods and undeveloped areas does no significant damage, and the silt deposits in these wooded areas are less of a problem than failed banks.

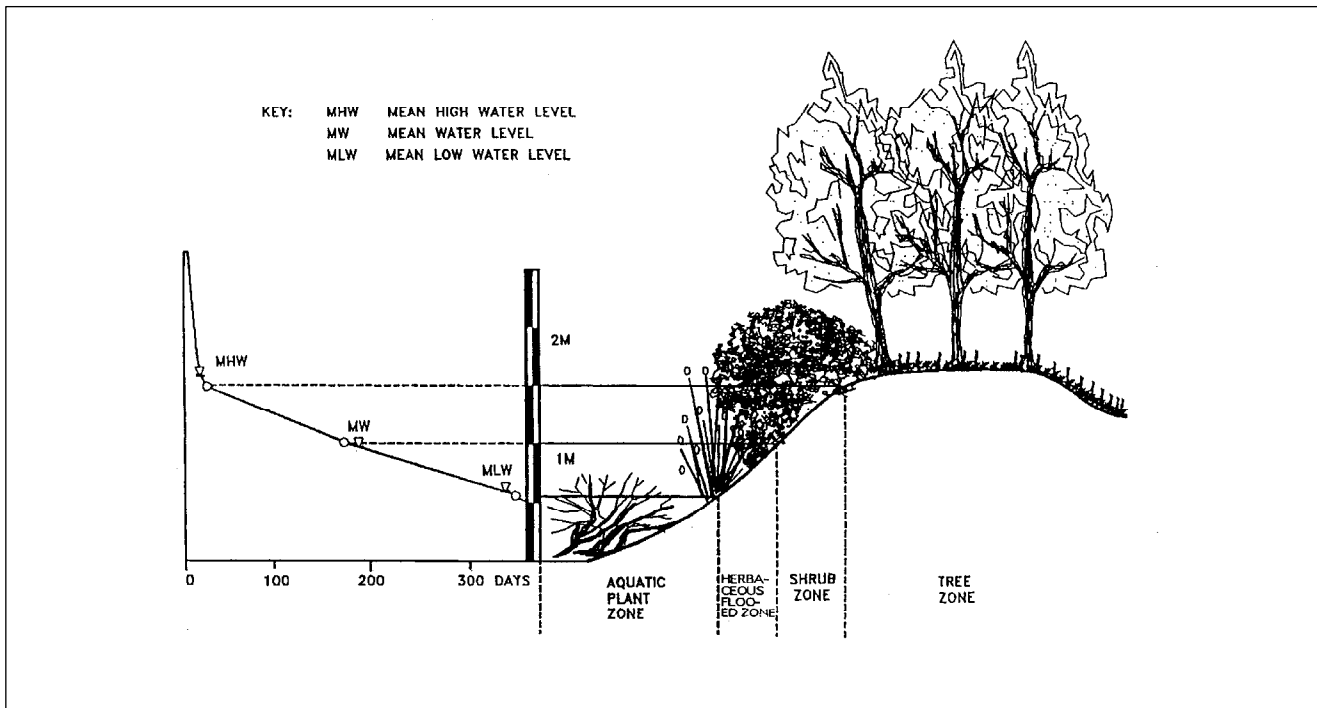

Figure 7.10a. Typical Annual Curve of Water Levels Correlated with Typical Vegetative Zones

Source: Seibert, 1968

Design Criteria

Table 7.2 provides general guidelines for the maximum allowable velocities in streams to be protected by vegetation. The following criteria should be incorporated into the design:

1. Ensure that channel bottoms are stable before stabilizing channel banks.
2. Keep velocities at bank-full flow so that they are nonerosive for the site conditions—i.e., maintain the stream at capacity, but with the water flowing slowly that it does not erode the streambanks.

3. Provide mechanical protection such as riprap on the outside of the channel bend if bank-full stream velocities approach the maximum allowable for site conditions.
4. Be sure that the requirements of other state or federal agencies are met in the design, in case other approvals or permits are necessary.

Table 7.2. Conditions Where Vegetative Streambank Stabilization Is Acceptable

Frequency of Bank-Full Flow	Maximum Allowable Velocity for Highly Erodible Soil	Maximum Allowable Velocity for Erosion-Resistant Soil
> 4 times/year	4 feet/second	5 feet/second
1 to 4 times/year	5 feet/second	6 feet/second
< 1 time/year	6 feet/second	6 feet/second

Source: Virginia DSWC

Planting Guidelines

Guidelines are presented only for Zones 2 and 3. Zone 1 is difficult to implant and establish naturally when herbaceous flooded zone vegetation is present. Currently, there are many federal, state, and private sector experts in this field who can provide assistance in successfully establishing plants in the aquatic zone.

Zone 4 is the least significant zone in terms of protecting banks from more frequent erosion force flows, since this zone is seldom flooded. Also, shade from trees in this zone can prevent the adequate establishment of vegetation in other zones.

Establishing a Herbaceous Flooded Zone

There are various ways of planting this herbaceous vegetation. The following plants are considered suitable:

Maidencane grass	(<i>Panicum hemitoman</i>)
Common reed	(<i>Phragmites communis</i>)
Great bulrush	(<i>Scirpus lacustris</i>)
Pickerelweed	(<i>Pontetaria cordata</i>)
Smartweed	(<i>Polygonum spp.</i>)
Arrowhead	(<i>Sagittaria spp.</i>)
Wild millet	(<i>Enchinochloa spp.</i>)
Catgrass	(<i>Leersia spp.</i>)
Blue flag	(<i>Zizaniopsis miliacea</i>)

Other plants may be used if approved in advance by local planning authorities or water management districts. Consultation should be initiated with the local NRCS and the University of Florida’s Institute of Food and Agricultural Sciences (IFAS). Another source of information is a local professional nursery. The following guidelines should be used to establish a herbaceous flooded zone:

1. **Planting in Clumps** – Most plants can be planted in clumps. Square clumps of entire plants are cut out of the ground and placed in pits prepared in advance on the chosen site. The clumps are planted at a depth where they will be submerged to a maximum of two-thirds their height.
2. **Planting Rhizomes and Shoots** – Less material is needed for the planting of rhizomes and shoots, which can be used to establish the common reed, maidencane grass, bulrush, smartweed, and other plants. Slips are taken from existing beds during the dormant season after the stems have been cut. Rhizomes and shoots are carefully removed from the earth without bruising the buds or the tips of the sprouts. They are placed in holes or narrow trenches along the line of the average summer water level, so that only the stem sprouts show above the soil.
3. **Planting Stem Slips** – It is possible to plant stem slips of common reed along slow-moving streams. Usually, 3 slips are set in a pit 12 to 20 inches (30 to 50 cm) deep. If the soil is packed or strong, the holes must be located approximately 1 foot (30 cm) apart.
4. **Using Reed Rolls** – In many cases, the first 3 methods do not consolidate the banks sufficiently during the period immediately after planting. Combined structures have therefore been designed, in which the protection of the bank is initially ensured by structural materials. Along slow to fairly fast streams, the most effective method of establishing herbaceous vegetation is the use of reed rolls, also known as wattles (see **Figure 7.10b**).
5. **Seeding** – Wild millet can be sown $\frac{1}{2}$ inch (13 mm) deep on very damp soil, provided that the seeded surface is not covered by water for several months after sowing. Seed at a rate of 20 pounds per acre (22 kg/ha).
6. **Using Vegetation with Stone Facing** – Vegetation can be planted in conjunction with riprap or other stone facing by planting clumps, rhizomes, or shoots in the crevices and gaps along the line of the average summer water level.

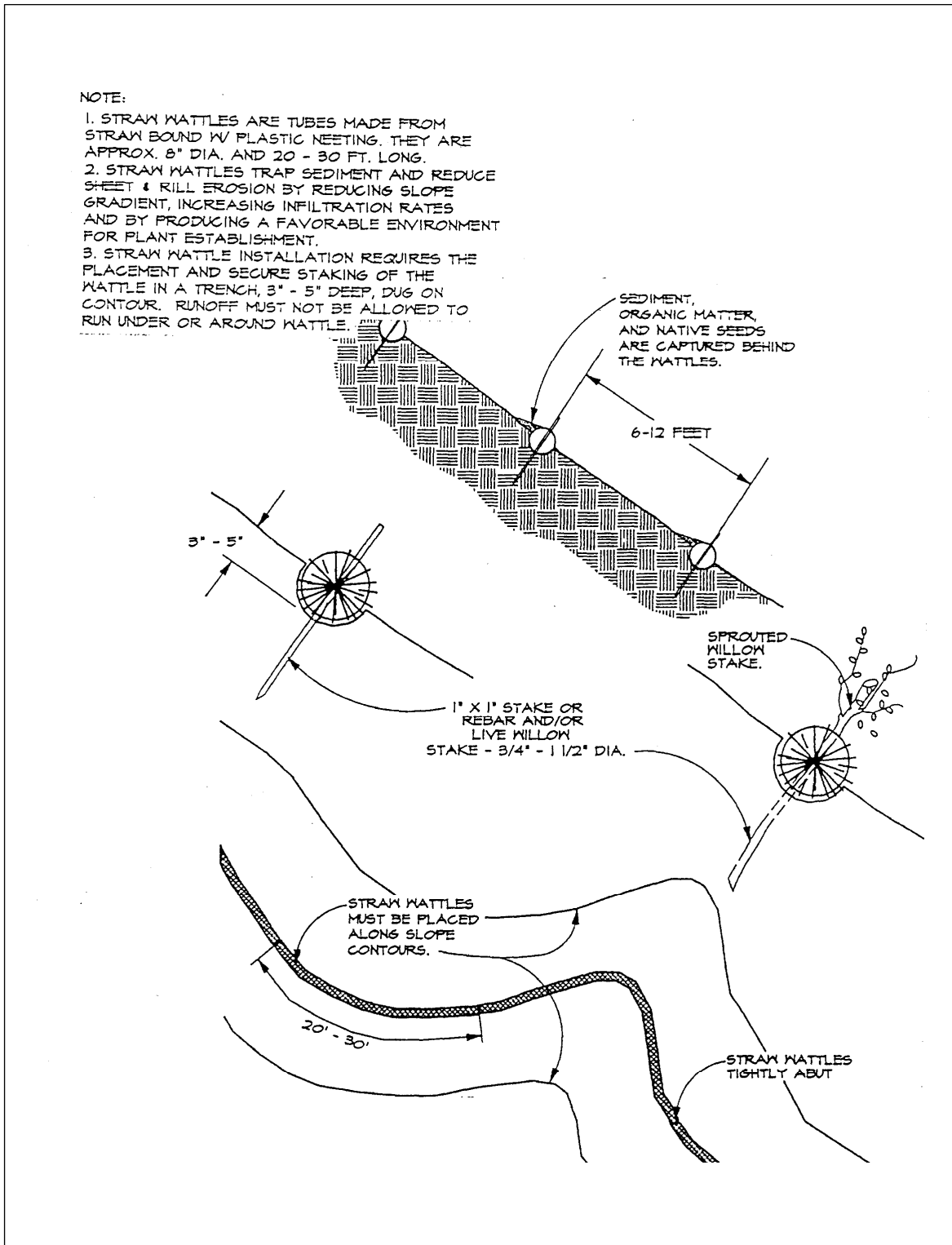

Figure 7.10b. Straw Wattles

Source: Erosion Draw

Establishing Shrub Zone Vegetation

Stands of full-grown trees are of little use for protecting streambanks, apart from binding soil with their roots. Shrub wood provides much better protection, and in fact riverside stands of willow trees are often replaced naturally by colonies of shrub-like willows. Plants should be used that can easily adapt to the stream and site conditions. The following procedures should be used to establish shrub zone vegetation:

1. **Seeding and Sodding** – *Frequently, if the stream is small and a good seedbed can be prepared, grasses can be used alone to stabilize the streambanks. To seed the shrub zone, first grade eroded or steep streambanks to a maximum slope of 2:1 (3:1 preferred). Existing trees greater than 4 inches (10 cm) in diameter should be retained whenever possible. Topsoil should be conserved for reuse. Seeding mixtures should be selected and operations performed according to **PERMANENT SEEDING** (in this chapter). Some type of erosion control blanket, such as jute netting, excelsior blankets, or an equivalent structure should be installed according to **MULCHING** (in this chapter). Sod can also be placed in areas where grass is suitable. Sod should be selected and installed according to **SODDING** (in this chapter). Turf should only be used where the grass provides adequate protection, necessary maintenance can be provided, and the establishment of other streambank vegetation is impractical or impossible.*
2. **Planting Cuttings and Seedlings** – *Selections that are commonly used include shrub willows, shrub dogwoods, and alders can be put into the soil as cuttings, slips, or stems. Willow (*Salix* spp.) and the swamp dogwood (*Cornus foemina*) or evergreen ground covers such as lily turf (*Liriope muscari*). On larger streams, willow (*Salix* spp.) has been widely used with success. Again, the first step in the planting process is to grade eroded or steep slopes to a maximum slope or 2:1 (3:1 preferred), making sure to remove overhanging bank edges.*
Willows can be planted as 1-year-old, nursery-grown, rooted cuttings or as fresh hardwood cuttings gathered from local motherstock plantings. Swamp dogwood and alders should be nursery-grown seedlings 1 or 2 years old.

Tab
Insert

CHAPTER 8: THE EROSION AND SEDIMENT CONTROL PLAN

- 8.1 Introduction
- 8.2 Elements of the Erosion and Sediment Control Plan
 - 8.2.1 *The Narrative*
 - 8.2.2 *The Map/Site Plan*
 - 8.2.3 *Construction Details, Specifications, and Notes*
 - 8.2.4 *Calculations*
- 8.3 Implementing the Erosion and Sediment Control Plan

* * * * *

8.1 Introduction

The erosion and sediment control plan is the document that describes who and what will control erosion and when, where, and how this will be done. The plan is the common link of communication between the designer, the contractor, and the inspector. A thorough understanding of the plan is essential for proper implementation.

8.2 Elements of the Erosion and Sediment Control Plan

The erosion and sediment control plan submitted to the approving agency with the project application should contain all the pertinent information for review and implementation. The following four elements should be present and are required in many communities:

1. *The narrative.*
2. *The map/site plan.*
3. *Construction details, specifications, and notes.*
4. *Calculations.*

8.2.1 The Narrative

The narrative briefly describes the overall strategy for erosion and sediment control. It should summarize for the plan reviewer and the project superintendent the aspects of the project that are important for erosion control and should include the following:

1. *A brief description of the proposed land-disturbing activities, existing site conditions, and adjacent areas (such as creeks and buildings) that might be affected by the land disturbance.*
2. *A description of critical areas on the site, including those with the potential for serious erosion problems such as severe grades, highly erodible soils, and areas near wetlands or waterbodies.*

3. *A construction schedule that includes the date grading will begin and the expected date of stabilization.*
4. *A brief description of the measures that will be used to minimize erosion and control sediment onsite, when they will be installed, and where they will be located.*
5. *A maintenance program, including frequency of inspection, provisions for the repair of damaged structures, and routine maintenance of erosion and sediment control practices.*

8.2.2 The Map/Site Plan

The map is the key item in an erosion and sediment control plan. It should show the following:

1. *Existing and final elevation contours at an interval and scale sufficient for distinguishing runoff patterns before and after disturbance.*
2. *Critical areas in or near the project area, such as streams, lakes, wetlands, highly erodible soils, public streets, and residences.*
3. *Existing vegetation.*
4. *The limits of clearing and grading.*
5. *The locations and names of erosion and sediment control measures, with dimensions.*

It is strongly recommended that standard symbols be used on the map to denote erosion and sediment control measures. The use of these symbols speeds up plan review and makes it easier for site superintendents and inspectors to understand plans quickly. The symbols were designed to be both pictorially representative of the control measures and easy to draw.

8.2.3 Construction Details, Specifications, and Notes

Construction details, often in large-scale, detailed drawings, provide key dimensions and spatial information that will not fit on the map. Other important information should also be provided, such as seeding and mulching specifications; equivalent opening size (EOS) and strength requirements for filter fabric; specifications for wire mesh, fence posts, and staples; installation procedures for control measures; and maintenance instructions.

8.2.4 Calculations

Include the calculations used to size the control measures, particularly the data for the design storm (recurrence interval, duration and magnitude, and peak intensity for the time of concentration) and the design assumptions for sediment basins and traps (design particle size, trap efficiency, discharge rate, and dewatering time). Also include calculations to support the sizing of storm drain systems when an engineered design is necessary.

8.3 Implementing the Erosion and Sediment Control Plan

There are seven principal steps, as follows, for installing an erosion and sediment control plan, primarily from the standpoint of the job superintendent:

1. *Study of the plan and site to organize implementation.*
2. *Preconstruction conference between the job superintendent and inspector.*
3. *Site preparation.*
4. *Inspection and maintenance of erosion control measures.*
5. *Grading and utilities installation.*
6. *Building construction.*
7. *Permanent stabilization.*

1. Study of the plan and the site to organize implementation.

The job superintendent must be thoroughly familiar with both the erosion and sediment control plan and the construction site. Note all of the critical areas indicated in the plan and then actually identify their location and extent on the ground. These should include stream channels and associated floodplain areas, drainageways, outlets into streams, points where land-disturbing activities are adjacent to or must cross streams and drainageways, steep slopes and highly erodible soils, and runoff entering the site from adjacent areas. Note what practices are specified to protect these areas. Also, be aware of critical areas not specifically treated in the plan and discuss these with the inspector at the preconstruction conference.

Next, determine the locations of all control measures and determine their "fit" on the land. Note any needed adjustments and plan to discuss these at the preconstruction conference.

Check the schedule for the installation of erosion and sediment control practices, the schedule for all earth-disturbing activities, and the relationship between the sequence and timing of BMP installation and the earth-disturbing activities. The timing and sequence of installation are important elements of an erosion and sediment control plan. The site must be ready for rain before the earth-disturbing activities are started. For this reason, certain practices must be in place and ready to provide protection before other areas are exposed. The staging of major earth-disturbing activities to limit the size of bare area exposed at any time is another important element of the plan that should be noted.

2. Preconstruction conference between the job superintendent and inspector.

The job superintendent should call for a preconstruction conference and site review with the erosion and sediment control inspector; the conference should be held on the construction site. The conference may also include the design professional, the owner, and inspectors from other agencies. The site review helps all parties meet their responsibilities.

All aspects of the plan should be discussed to ensure that the job superintendent and the inspector are in agreement in interpreting the plan, scheduling, procedures, and practices to be used. In particular, they should agree on the critical problem areas and on the perimeter practices specified to prevent damage to adjacent properties.

The location of all measures should be discussed. If a study of the plan indicates that adjustments in location are needed, these should be discussed with the permitting agency and the inspector. The inspector may authorize minor adjustments such as moving a diversion from a property line to a grading limit, or shifting an outlet to match a natural depression in the land. Major adjustments require a formal revision of the plan and should be approved by the permitting agency.

The sequence for the installation of practices and earth-disturbing activities should also be discussed. The guidelines for erosion and sediment control planning require that sediment basins and other appropriate erosion and sediment control measures be installed prior to or as a first phase of land grading.

Other appropriate measures include construction entrances, diversion berms, interceptor berms, perimeter berms, gravel outlet structures, level spreaders, swales, protected outlets, and grade stabilization structures. The job superintendent and the inspector must be firm about the establishment of these practices before grading begins. The **Appendix** to this manual provides a sample preconstruction checklist.

3. Site preparation.

One of the first tasks in preparing the site is to lay out all traffic circulation routes and storage areas. Route locations should be chosen to pose the least threat to the critical areas that have been identified. Well-vegetated areas should be damaged as little as possible. Soil stockpiles should be located a safe distance from waterways and streams. Barriers may be required to keep traffic within the delineated areas or at least out of the critical areas. If needed, barriers should be installed before opening the site to general construction traffic. The workforce should be instructed about the location of critical areas and sediment control practices and the need to protect these areas from damage.

Required sediment-trapping practices should be installed. Note that compacting, seeding, and mulching are required to stabilize these practices. Next, waterways and outlets should be installed with the vegetation or lining material called for in the plan.

4. Inspection and maintenance of erosion control measures.

Maintenance differs from the other activities in that it must begin as soon as the first practice is installed and must continue through all the succeeding activities until the permanent erosion control measures are established and functioning. The narrative part of the plan describes the features of a maintenance program. All structural measures should be checked at the close of each workday and particularly at the end of the workweek. Also, they must be checked before and after each rainstorm of ¼ inch or more.

Diversion berms should be checked to see that they have not been breached by equipment. The condition of level spreader areas, waterways, and other outlets should also be checked. Traffic should be moving within the established access routes.

Channels should be checked for sediment deposits or other impeding material. Repairs should be made promptly when damage is discovered. When repairing swales or other channels, the new lining material should be at least as erosion resistant as the original material.

Vegetative measures and vegetative cover on structural BMPs require maintenance fertilizer and perhaps mowing. All sediment traps should be checked and cleaned out after each storm. Sediment basins should be cleaned out when the deposited material reaches the level designated in the plan or standards and specifications. The **Appendix** to this manual provides a sample maintenance checklist.

5. Grading and utilities installation.

If the stockpiling of fill or topsoil is planned for use in grading, a preselected, relatively safe stockpile area should be used. To minimize the hazard of erosion, the slopes of the stockpile should be flattened at the end of each working period. The stockpile should be mulched and seeded as soon as it is completed.

Disturbed areas that can be brought to final grade at this stage during a satisfactory season for seeding should be seeded, sodded, or otherwise stabilized with the permanent material and techniques indicated in the plan. If they cannot be seeded, they should be stabilized with anchored mulch. Areas that are to remain at rough grade for more than seven days before permanent stabilization must be mulched and seeded to temporary cover immediately following rough grading.

Utilities such as storm sewers, sanitary sewers, electrical conduits, water mains, and gas mains are usually installed at this time. To minimize the amount of area disturbed, the work should be organized and the trenches sized to accommodate several utilities in one trench. The installation should be carefully coordinated to reduce the time that the trenches must stay open. Excavated materials should be placed on the side of the trench away from streams and conveyances. If sediment-laden water must be pumped from utility trenches, it should be conveyed safely to a sediment trap or basin. As soon as possible, trenches should be filled, compacted, mulched, and seeded to temporary or permanent vegetation.

As soon as the storm sewers are installed, inlet sediment traps should be installed to prevent sediment from entering the system. If called for, storm drain outlet protection should be installed.

6. Building construction.

The following two major hazards are common during building construction:

- 1. Additional equipment and work force bring added risks to areas that should be protected. Efforts to control traffic must be increased during this period. All types of traffic should be made to stay on the established travel routes.*
- 2. The excavating process usually results in large quantities of soil for disposal and stockpiling. Stockpiles should be located where they will not wash into drainageways or onto previously stabilized areas. The slopes on these areas should be flattened, and they should be protected by anchored*

mulch and temporary seeding. Excavations should be backfilled as soon as possible, and appropriate surface protection should be provided.

Runoff from rooftops should be directed to stabilized areas upon the completion of the structure. Whenever possible, runoff should be treated or infiltrated in swales or retention facilities. Rooftop runoff should never be tied in to sanitary sewers.

7. Permanent stabilization.

This process need not and should not be delayed until the entire development is completed. Erosion damage repair costs and regrading costs can be significantly reduced if smaller areas are stabilized with permanent vegetation as soon as they are ready.

Most sediment basins, berms, sediment traps, and other control structures should be removed, regraded, mulched, and seeded before a construction project is completed. However, the inspector should be consulted before removing them—they should not be removed until the surrounding area is stabilized and they are no longer needed.

In some cases, sediment basins, diversions, and swales will remain as part of the permanent runoff management system. In such cases, the sediment basins should be cleaned out to provide the required capacity and stabilized with suitable permanent vegetation. Diversions and swales should be checked, repaired if needed, and left in good condition. The inspector will check on the final condition of measures that are to be retained.

When final grading is completed, all bare areas should be stabilized with permanent vegetation. **Chapter 7** of this manual and Chapter 6 of the *Florida Development Manual* provide information on the standards and specifications for permanent vegetative practices, and on the various materials and methods for permanent stabilization.

Tab
Insert

CHAPTER 9: INSPECTION AND ENFORCEMENT

- 9.1 Introduction
- 9.2 The Role of the Inspector
 - 9.2.1 *Conduct*
 - 9.2.2 *Compliance*
 - 9.2.3 *Handling Violations*
- 9.3 Site Inspection
 - 9.3.1 *The Inspection*
 - 9.3.2 *Tolerances*
 - 9.3.3 *Preparing for an Inspection*
 - 9.3.4 *Preconstruction Conference*
 - 9.3.5 *Before You Leave the Office*
 - 9.3.6 *Inspecting the Site*
 - 9.3.7 *Causes of Noncompliance*
 - 9.3.8 *Inspection Reports*
- 9.4 Regulatory Agencies

* * * * *

9.1 Introduction

The specific duties and responsibilities of the inspector depend in part on the employing agency or company; however, many of these duties and responsibilities are common to all inspectors. This chapter describes the essential tasks carried out by all inspectors. There is no substitute for on-the-job training from experienced inspectors or supervisors, as well as a broad understanding of associated environmental issues.

9.2 The Role of the Inspector

The material in this section is intended primarily for inspectors employed by regulatory agencies. Except for enforcement issues, most of the material also applies to inspectors working for private firms. Private inspectors may also be called on to monitor and document other matters, such as costs, schedule adherence, the consumption of supplies, and program implementation.

9.2.1 *Conduct*

The inspector must have technical expertise in erosion prevention and sediment control. Knowledge of other programs such as the state’s wetlands permitting/ERP programs is helpful. Effective communication and people skills also are an asset to a field inspector. The inspector must remember that the goal of a compliance inspection is to evaluate the performance of a site’s sediment and erosion control practices in an unbiased manner. Regulated receiving waters must be protected to the maximum extent practicable during construction activities. If the site is not achieving compliance, then the inspector or regulatory agency may offer potential solutions and recommendations to achieve

compliance. No matter what the situation, inspectors need to carry out their responsibilities in a professional manner and in accordance with the rules. Inspectors must be consistent in their inspections, handling all sites, individuals, problems, and violations equally.

In dealing with the public, it is essential to follow proper legal procedures and to remain professional, courteous, and fair to encourage mutual respect at job sites. Regulatory agencies as well as private companies typically have standard operating procedures defined for the inspectors to follow during inspections. For further details on enforcement procedures and legal policies/procedures, an inspector should contact the appropriate Office of General Counsel or legal division.

9.2.2 Compliance

Remember that the goal of the permitting program is to prevent accelerated erosion and offsite (receiving water) sedimentation, as well as associated pollution that may be mobilized by the processes of erosion and sedimentation. As the inspector, you are the first person to determine if the performance standards and intent of the erosion and sediment control rules are being met. You are the key person ensuring that construction sites are evaluated according to the permit conditions and that the responsible party is notified regarding site compliance.

The erosion and sediment control rules are performance oriented. That is, the measures used at a construction site **must be effective in controlling erosion and preventing sedimentation from reaching a regulated receiving water for the site to be in compliance**. Following an approved plan and installing the control measures **may not** be enough for a site to be in compliance. The responsible authority must ensure that additional measures are installed to correct problems and may have to correct/mitigate any adverse environmental impacts that occur. The erosion control plan may also need to be updated to reflect changes in site conditions and BMPs.

The rules are flexible, allowing the responsible parties to decide the most economical and effective means for erosion control. This encourages the use of innovative techniques and specifically designed erosion control systems. As the first person to recognize performance failures and report problems, the inspector is a key individual in making these kinds of performance-based rules work. The inspector's job is as follows:

- 1. Determine that an erosion and sediment control plan for the site has been developed and approved, where applicable.*
- 2. Determine that all specified practices have been installed and are being fully and properly maintained.*
- 3. Determine that offsite sedimentation and turbidity in receiving waters are being prevented.*

If the inspector finds deficiencies, then the responsible authority should be contacted immediately for appropriate action to be taken to attain compliance expeditiously.

9.2.3 Handling Violations

As the inspector of the site, you play a central role in providing details of violations and subsequent corrections. The inspection records that you write could be the basis for enforcement and administrative/civil penalties and could be used for potential criminal actions. Inspectors are often called on to appear at enforcement meetings or hearings as witnesses to document a violation. Conversely, an accurate enforcement case can serve to refute a suspected violation.

You should write a report for every site inspection. When writing your inspection report, remember that it is a legal document and may be public record. Your report must be written legibly, accurately, consistently, and in clear and concise language. Most important, it should only contain defensible facts and not hearsay or opinion. Report all violations observed each time you visit a site, even if you have reported some of them on previous visits. **Always write inspection reports while you are on the site** so that you will not forget items and can recheck conditions if you have doubts. Field notes also can be effective in meetings. They should be organized, thorough, concise, and legible. Make a habit of taking organized, well-written notes. It will pay off if you are involved in an enforcement case or need to offer solutions to a particular problem.

The private inspector must also document activities thoroughly and accurately. This is the client's best defense in the event of a violation. Good documentation shows whether the client is a "habitual offender" or a conscientious professional who has been overwhelmed by unusual events, often an important factor in determining a resolution.

9.3 Site Inspection

Inspections don't "just happen." A great deal of planning and preparation goes into a proper and thorough inspection. Inspectors need to review construction plans, attend preconstruction conferences, and be knowledgeable about the law and standards.

9.3.1 The Inspection

An erosion control plan is designed to minimize erosion, control sedimentation, and address other potential sources of pollution. However, some components of the plan may fail, or the responsible party may not adhere to the plan. As an inspector of construction sites, your job is as follows:

1. *To be certain that all erosion and sediment control measures and other BMPs in the approved plan have been properly installed and maintained.*
2. *That erosion is being controlled.*
3. *That offsite sedimentation is being prevented.*
4. *That no turbidity is being generated in receiving waters.*

It takes time to learn how to inspect a construction site properly. Project sites are often large and can have many land-disturbing activities occurring at the same time, which can be confusing. Also, there are many considerations to keep in mind while conducting an inspection. You must be familiar with the rules and with many different erosion and sedimentation control practices. With some experience, however, you will soon feel comfortable about making an official erosion control inspection.

A proper inspection requires planning and a systematic approach. With careful preparation, you can carry out your duty and work cooperatively with all responsible parties so that those involved can do their jobs efficiently and effectively. Remember, the ultimate goal is to protect water quality.

9.3.2 Tolerances

The inspector must be reasonable regarding dimensional and performance criteria while performing inspections. This requires an understanding of the intended function of various BMPs. Obviously, a catch basin with an opening designed to support a grate has a zero tolerance for being too small because the grate will not fit. If the opening is one-half inch too wide, the grate will fit and still be supported by the sill or lip. If the opening is two inches too wide, the grate will fall in. This dimensional tolerance can be described as "half-inch plus, zero minus."

A stormwater pond is often designed with 1 foot (30 cm) of freeboard over the riser or spillway. High spots or slightly low spots in the bottom of the pond probably will not affect the performance of the pond. On the other hand, it is critical that the lip of a level spreader is installed "perfectly" level. In this situation, high or low spots will both have the effect of producing concentrated flows. Thus there is almost zero tolerance, plus or minus.

Other situations are not as simple to define. The potential for impacts and allowable (minor) amounts of mud tracked, or dust generated from a site, may be somewhat subjective. Many factors are involved in determining performance tolerances, such as the severity and frequency of infractions, efforts by the contractors, limitations of the technology and products available, etc. However tolerances are determined, it is essential to the integrity of the inspector and the agency that they are applied consistently and impartially. It should be noted that "convenience" is not considered a limiting factor.

9.3.3 Preparing for an Inspection

The first step in inspecting a project is to review the plans when first submitted. This alerts you to potential problems at the site and weaknesses in the design of the erosion and sedimentation control system. While at your office, look for the following items in the plan (there are other items that you may want to include as you gain more experience):

- 1. Check contour maps and available aerial photos to see how the water flows through the site. Note where water enters and leaves the site. Determine the direction of flow, the watershed where the project is located, and the receiving water(s).*
- 2. Note critical or sensitive areas, such as a wetland, stream, conservation easement, pipe outlets, extreme slopes, etc., that may border the site. These areas must be well-protected from impacts.*
- 3. Look for adequate access and space to maintain erosion and sediment control measures during and after construction.*

4. *Make sure that the plan provides an installation sequence for the construction of BMPs, with measures for one phase being installed before the grading of the next phase begins.*
5. *Study the construction schedule to determine whether there are long periods between phases of construction. If so, temporary seeding or other temporary soil stabilization may be required.*
6. *Check to make sure that the plan requires all surfaces to be stabilized as soon as possible after the completion of the project and within seven working days. The plan should state the preferred stabilization method.*
7. *Ensure that all potential discharge points (wetland boundaries, stormwater management system outfall structures, MS4s, construction entrances, etc.) are protected with sufficient BMPs to prevent pollutants from entering and impacting receiving waters. It may be also beneficial to divert run-on from adjacent property around highly erodible areas during construction.*
8. *Make sure that maintenance plans are adequate and that the contractor's performance-monitoring procedures are specified. For example, it should be specified clearly whether the general contractor, subcontractor, or construction manager is to do the inspection and maintenance.*
9. *Note any proposed borrow, stockpile, and waste storage areas on the plans and indicate which BMP will be used.*
10. *Make a list of specific items in the plan that you want to inspect closely when visiting the site. Highlight potential problem areas before leaving the office.*
11. *Reviewing the erosion and sedimentation control plan should provide you with a solid grasp of the proposed project. From the review, you can identify parts of the erosion control system that may need to be strengthened and parts that should be watched carefully to see if the performance requirement is met. Your experience in the field and in a particular geographic area provides valuable assistance in the approval or revision of the submitted plan.*

The ability to read aerial photos is important because some construction projects now draw the construction plans on aerial photos. It takes some practice to be able to recognize ordinary objects from the air.

Many experienced people have found that aerial photos and topographic maps can help greatly in determining the effects of a project on the surrounding area. Aerial photos can be obtained from FDOT. The 1:660 scale generally is used. The U.S. Geological Survey (USGS) is a good source for topographic maps. These are drawn on a scale of 1:24,000. Also, FDEP's Water Data Central Website provides a portal for a geographic information system (GIS) based program to obtain a plethora of vital information.

Reviewing the construction plan provides information needed for the next step of the inspection process, the preconstruction conference. Use the suggestions below to ensure that you are fully prepared for the conference.

9.3.4 Preconstruction Conference

A preconstruction conference is one of the most valuable vehicles through which you can address and avoid potential erosion and sedimentation problems, as well as environmental impacts. It provides you with an opportunity to meet face-to-face with the responsible authority and the contractors. In this way, you can establish the expectations for the project and start a good working relationship with the involved parties.

During the conference, keep the following suggestions in mind:

1. *Clarify the objectives of erosion and sediment control and inform all parties of the specific requirements for compliance in this project. Also, discuss the inspection procedures and schedule for major earth-moving activities.*
2. *Ask the responsible authority to designate a contact person for communicating compliance issues and concerns.*
3. *Be sure that all parties receive/view a copy of the approved erosion and sediment control plan.*
4. *Inform the responsible authority and contractors that the program is performance oriented and that the plan may need to be updated during the course of construction. Inform all parties about procedures for changing the plans.*
5. *Try to hold the conference onsite so the group can walk the site. Evaluate the plans to determine whether the measures are appropriate, are located properly, and can be maintained once installed.*
6. *Discuss the schedule for clearing and grading. Emphasize that sediment control measures should be installed before the actual grading begins, in order to capture sediment as it is generated. Be sure that the schedule allows for stabilizing surfaces with temporary and permanent measures between phases of grading and construction.*
7. *Discuss the maintenance requirements so that the responsible authority and contractors know who is responsible for inspecting, cleaning, and repairing the erosion and sediment control measures. Regular inspection and maintenance may need to be supplemented with extra work if a large storm is forecast, or if there are cleanup activities after a large storm, or even if there is a higher-than-normal amount of site activity.*
8. *Establish open communications at the preconstruction conference; this provides a good foundation for your relationship with the responsible authority during the project.*

9.3.5 Before You Leave the Office

The following suggestions are important before you leave the office for the construction site:

1. *Take the time to review the plans thoroughly before you go to the site, even if you have already reviewed them when they were first submitted.*

2. *Outline your approach for each inspection. It is necessary to know in detail the erosion control system specified.*
3. *Always take a copy of the approved plans with you to the site for quick referral (unless they are already onsite).*
4. *Always bring the project file and necessary reporting forms.*
5. *Always take equipment for measuring (level, tape measure, turbidity sampling kit, etc.) and documenting (camera, camcorder).*
6. *Be sure to have all necessary personal protection equipment with you, such as boots, hard hat, sun and insect protection, rain gear, water, first-aid kit, radio, etc.*

9.3.6 Inspecting the Site

At the construction site, ask yourself the following eight questions:

1. *Does this project have an approved permit?*
2. *Is the erosion and sediment control system installed as shown on the approved plans?*
3. *Is erosion being controlled onsite?*
4. *Is sediment being contained onsite?*
5. *Is potential turbidity in receiving waters being prevented?*
6. *Are inspections being recorded and available for review?*
7. *Are previous noncompliance issues and maintenance activities addressed within seven days of their occurrence?*
8. *Are other potential sources of pollution being controlled?*

If the answer to **ALL** of these questions is YES, then the site is in compliance. File an inspection report stating that the site is in compliance and take field notes to support the inspection report. It is a good idea to keep track of the sites where the erosion and sedimentation control plans work well, so that you can show others examples of good sites.

If the answer to **ANY** of the above questions is NO, then the site is not in compliance. File an inspection report listing the items that are not in compliance. Your field notes should describe precisely each noncompliance issue and its location. Remember that others may need to use your field notes, so make them readable and understandable. The following points will help you in checking for compliance:

1. *Carry a set of the approved plans to the site for your reference. They are necessary to determine what measures make up the erosion control system and how they are to be installed and maintained.*
2. *Take detailed, orderly field notes as you do the inspection. Be sure that your notes are neat, concise, and complete (remember, they may be needed as evidence in court).*

3. *Check in with the job superintendent when you arrive so that the contractor knows who you are and what you are doing.*
4. *Walk the perimeter of the site. This gives you a good idea of the terrain and alerts you to any problems with offsite water and sedimentation.*
5. *You may want to start your inspection from the lowest point and work your way upstream through the stormwater management system/site. This helps to make you aware of the amount of sediment leaving the site and can help you locate its source.*
6. *If sediment is flowing offsite, go far enough downstream to see the extent of the damage. In these situations, it is important to document the damage. Estimate the sediment volume. Photos and videotapes make good evidence. Be sure to write the time, date, and other items in your notes and on the inspection report. If there are other sites contributing to downstream impacts, make sure to document these as well.*
7. *If turbidity is present in nearby waters, sampling upstream and downstream of the discharge point can provide the best possible evidence that the site is in or out of compliance.*
8. *Bring the necessary tools to measure the devices and disturbed areas in the field. Be sure that basins and traps are sized according to the plans, that channels and diversions have the proper grade, and that contributing areas for the control devices are no larger than those used in the design.*
9. *Pay particular attention to the maintenance of erosion and sediment control measures. All measures require regular maintenance and may require special attention after severe storms.*
10. *Keep in mind that when certain structural measures fail from improper installation or maintenance, more offsite sediment damage may occur than if the device had not been installed.*
11. *Always fill out an inspection report for each trip to a site while you are at the site. The pertinent inspection points are fresh in your mind and you can recheck items that may be in question.*

9.3.7 Causes of Noncompliance

When you find a site that is not in compliance, it is important to determine why. By determining the cause(s), solutions become more apparent. Erosion and sediment control problems on sites generally fall into the following four categories:

1. *The responsible party has made little or no effort to comply.*
2. *There are design errors in the erosion control system or the site conditions have changed.*
3. *The installation or maintenance of a measure is faulty or inadequate.*
4. *Severe weather has occurred.*

1. The responsible party has made little or no effort to comply.

Noncompliance is normally easy to identify. The responsible party may believe that the project does not come under the jurisdiction of the rule or may intentionally disregard the provisions of the rule. Quite often these sites are found by inspectors while driving by. Therefore, be observant in your territory.

Once you have found a non-complying site, inform the responsible authority that compliance is mandatory. On the inspection report, note that the responsible authority has been informed of the law and list the items that are not in compliance. Appropriate enforcement action should be taken. The following are some of the causes of noncompliance in this category:

1. *Failure to apply for a permit or submit a plan.*
2. *Failure to follow the approved plan.*

2. There are design errors in the erosion control system or the site conditions have changed.

Violations and failures may occur because the design was inadequate or the site conditions have changed since the plan was prepared. In this event, the plan needs to be revised and approved. The inspection report should note all items of noncompliance and the need for a revised plan.

Compare the original design with conditions in the field. Look for changes in the site conditions and construction plan. Ask yourself the following questions when checking for violations caused by design errors and changes:

1. *Are the planned measures retaining the sediment onsite?*
2. *Are there modifications to the plan?*
3. *Are ground covers adequate for the slope and orientation of the areas to be protected? Is the slope too steep for the ground cover chosen?*
4. *Is the perimeter protected, given the conditions at the site?*
5. *Have the contributing drainage areas changed significantly, thus potentially overloading the control measures? Are additional control measures needed?*
6. *Is the maintenance plan adequate for the existing conditions?*

Again, appropriate enforcement action should be taken.

3. The installation or maintenance of a measure is faulty or inadequate.

Most noncompliance occurs because measures were not installed correctly or maintained properly. Determining the reasons that the measures are failing requires technical knowledge about the devices and how to construct them properly.

4. Severe weather has occurred.

Occasionally, a meteorological event or a series of events that cannot be planned for results in noncompliance. These types of issues must be handled carefully. For example, if a site receives more than six inches of rain in each of three separate storm events over a period of a week or two, there is a good chance that the BMPs used will have at least partially failed. Another example is a tropical system, which can produce well over a foot of rain. These types of mitigating circumstances must be taken into account using the following two guidelines:

1. *If the storm event was predicted, did the site take all “reasonable” steps to minimize any potential adverse environmental impacts?*
2. *Regardless of whether the storm was predicted, what steps did the site take to address and mitigate the impacts to return the site to compliance, and how quickly did they take these steps?*

Remember when evaluating a noncompliance issue or violation to also adhere to the established procedures and policies of your agency and to take into account whether a violation was caused by ignorance, belligerence, or other reasons.

9.3.8 Inspection Reports

Inspection reports can have many different formats, styles, and looks. However, the most important aspect to designing or using an inspection report is making sure that it addresses all of the requirements of your jurisdiction. Some inspection reports only address physical issues, while others also handle administrative issues. In general, though, it is recommended that whatever report form you use, adhere to the following procedures so that you have a clearly worded, defensible, and usable product:

- *Document all findings on the inspection forms:*
 - Forms should be filled out completely with no blank spaces. If something is not applicable (N/A), then indicate N/A. If something was not checked, indicate N/C. There should be no blank cells. Your inspection form becomes part of the site’s (or your office’s) administrative record, so make it accurate, detailed, impartial, and defensible.
 - A Notes/Comments section is suggested so you can expand on some items that may be performance based but that are not permit compliance issues—for example, “It is recommended that subcontractors not be allowed to park on the lots, as it causes more dirt to be tracked into the road.” While this is not a permit-related compliance item, it is a good suggestion that can be offered.
 - Make sure that the inspection date is indicated.
 - Make sure to indicate what type of inspection this is: Initial, Follow-up, Weekly, After Rain Event, Monthly, etc.
- *Only indicate facts on the inspection report, not opinions.*
- *A signed hard copy of the report should be left at every inspection site if possible.*
- *Let your site contact know that you have completed your inspection. At the very least, make sure to debrief them on all noncompliance issues.*

- *Understand that the construction site, the SWPPP/plan, and the inspections do not occur in a vacuum. There needs to be dynamic interaction between all of these elements for full compliance to be achieved.*

Chapter 3 provides an **EXAMPLE** of what a potential inspection report may look like; however, remember that not all inspection reports are good for every situation.

9.4 Regulatory Agencies

There are multiple levels of regulatory oversight associated with erosion and sediment control. The following list, while not fully inclusive, briefly describes many of these agencies and their jurisdictions:

1. **U.S. Environmental Protection Agency (EPA)** – Oversees the federal wetlands program and the NPDES Stormwater Program.
2. **U.S. Army Corps of Engineers (USACOE)** – Has jurisdiction over the permitting of the federal wetlands program, Section 404 of the federal Clean Water Act, and Section 10 of the federal River and Harbors Act.
3. **Florida Department of Environmental Protection** – Oversight of the state of Florida's wetlands programs and the permitting authority for the state's NPDES Stormwater Program and some dewatering activities.
4. **Water Management Districts** – There are five water management districts in the state: North Florida, Suwannee River, St Johns River, Southwest Florida, and South Florida. These regional agencies implement the state's wetlands permitting program for most larger types of projects, as well as consumptive use/dewatering permits.
5. **Counties/Cities/Community Development Districts/Other Special Districts** – These governmental entities have a multitude of local ordinances that can be more restrictive than those of the federal, state, and regional governmental programs.

The best way to achieve compliance with all of the different permits that a site may be operating under is to achieve compliance with the most restrictive requirements (permit), and then you should be in compliance with all the other permits that you may be under.

Appendix 9-A Human Relations

The hardest part of an inspector's job is dealing with people. You will be working with contractors, developers, neighbors, and concerned citizens. All have rights as citizens and as human beings.

To deal effectively with people, you must be fair and consistent. You must follow the rules governing erosion and sediment control, and you must apply them fairly. Fairness means treating all people with courtesy and respect. If you show respect for the other person, that person is more likely to show respect for you. It is important to be as consistent as possible. If you apply the rules consistently to every situation, the people you deal with will know what to expect from you and your agency.

Perhaps the most challenging part of being an inspector is carrying out your responsibilities in a professional manner. Sometimes you may feel pressured not to cite violations, but it is your job to make sure all rules are followed. The objective is to prevent accelerated erosion and off-site damage from sediment. To do this job well and be respected as a professional, you must maintain your integrity.

You will visit many construction sites, offices, and other agencies. For these visits, prepare a short introduction explaining who you are, what your job is, and why you are there. Give a business card to those you meet to help them remember your name and the role of your organization.

Dealing with Angry or Difficult People

Individuals who have complaints frequently come to the inspector. Consequently, the inspector often has to handle heated confrontations.

When a person voices a complaint, you will not have time to prepare a response. Therefore, you must resolve the situation spontaneously. You can be prepared, however, by developing skills for dealing with conflict situations. The general guidelines in the following section will help in handling angry people.

Key Steps

A situation with an angry person should be handled in a manner that is satisfactory to the person, yourself and the organization you represent. Your organization relies on you to handle these situations effectively. Use these steps as a guide for developing your skills in dealing with angry people. You can tailor these skills to fit your own personality and style:

1. Maintain a friendly and professional manner.

You are likely to be the first person an angry individual confronts. Be careful not to argue because it will only make the person become defensive and even more difficult. Show an interest in the person's problem and express your desire to solve it. Do not let the person's anger arouse your desire to retaliate. Handling a conflict situation diplomatically is your professional responsibility and can be rewarding. Do not take what the individual says personally.

Though the anger may be directed at you, the person is probably angry with your agency or regulations, or another agency, person or rule. The individual probably feels that someone has treated him or her unfairly.

2. Acknowledge that a difficult situation exists.

Show that you take the complaint seriously. It is important that you help the person maintain self esteem. The complaint must not be viewed as unimportant. The person would not be complaining if he or she did not consider the problem important. Choose words and use a tone of voice that show sensitivity to the party's situation. The person wants to know that you understand the situation. An angry person does not want to hear (and probably is unable to hear) that he or she is wrong. Express empathy by responding to what the person says and feels. Expressing empathy does not mean you agree with the individual. It means simply that you recognize and respond to what the person is experiencing. If an apology is in order, apologize for the specific incident and no more.

3. Calm the individual by questioning and verifying.

By asking questions you can verify your understanding of the situation and also demonstrate that you are willing to work with the person. This also helps the person to work with you. Ask questions to get specific information about the problem. Never assume that you understand. Give the person responses to show that you understand the problem. Be sure that you and the person fully understand the problem.

4. Involve the person in solving the problem.

The next step is to get the person to cooperate in exploring alternate solutions. Show that you are interested in solving the problem. By discussing all alternatives and the consequences of each solution, you can keep the party focused on the problem and thereby avoid side issues. Ask the person to help you solve the problem. Request suggestions for solving the problem, and offer your assistance to help correct the situation. Your knowledge of erosion and sediment control can guide the party to a reasonable and legal solution. Explain the applicable regulation and the reasoning behind it. Often frustration and adversity are reduced when citizens are made aware of the intent of the rules. Continue to ask questions in order to keep the person focused on solving the problem. If the individual is still angry, continue to empathize, showing that you understand the problem.

5. Handle the problem

Having explored the possible solutions, focus on the most feasible and satisfying solution. Be positive with the person. Explain what you are going to do in a way that the person understands. If he resists, go on to another alternative. Be as helpful as you can. Satisfying the person's desire for service and special attention can sometimes turn an opponent into an advocate. Decide upon a follow-up action to ensure that the problem has been resolved satisfactorily.

Being the Bearer of Bad News

There will be times when you will have to be the bearer of bad news. You may have to tell a person that you cannot solve a complaint to his or her satisfaction, or you may have to inform a responsible party of a violation. These situations can be very stressful for both you and the other person. The following section lists key steps that will help prepare you to deliver bad news.

Key Steps

1. Present the Situation

Explain the situation to the person with as few words as possible. When your discussion is concise, direct, and to the point, the person is spared the anxiety of wondering how bad the news is. Prepare the person for the negative information. It may be necessary to provide a short background about the events leading up to the present situation. Provide reasons why the situation has occurred. You may be able to show that the person's actions were not responsible for the situation. Do not try to give the person good news first and then the bad news--this can appear patronizing. Do not make the bad news seem insignificant; it probably is not insignificant to the person involved.

2. Allow the person time to adjust

Most people need a little time to collect their thoughts and react emotionally to bad news. Allow the person some time, but try not to leave long periods of silence. Some people perceive silence as pressure to react and therefore may react inappropriately. Try discussing the positive aspects of the situation. The person may or may not hear you, but positive comments can help keep the conversation constructive and the outlook optimistic.

3. Accept the person's reaction

Allow the person to express his or her feelings and opinions. It is normal to react emotionally to bad news. Allowing people to ventilate their emotions shows that you accept their feelings and helps to reduce the negative aspects of the situation. If the person does not offer a reaction, try talking briefly about how you have felt or would feel in a similar situation. Then ask for the person's reaction. Use this technique to stress that you are empathetic to the other person's dilemma. However, do not get caught up in discussing your own troubles.

4. Demonstrate acceptance of the person's reaction

A person may react emotionally in many different ways and may not clearly express his or her feelings. By accepting their emotions you reaffirm them as valuable and important. Most of us find it hard to talk about emotions in the workplace, and we have trouble accurately identifying the emotions of others. You must observe and listen carefully to determine if the person's true feelings are being expressed. When receiving bad news, the person may feel a wide range of emotions, such as anger,

dissatisfaction, embarrassment, or confusion. Respond to these emotions by remaining calm, expressing empathy, offering reassurance, or providing further explanation. Try to mentally identify or name the emotion that the person is feeling. Identifying the person's reaction allows you to accept the reaction for what it is -- that is, not a personal affront to you. Understanding how the other party feels also helps you anticipate upcoming statements and remain in control of your own emotions.

People often react by blaming another person, a group, or the system. The person is simply reacting from his anger -- try not to take it personally. Avoid being caught in answering questions that are really meant as statements. For instance, "Don't you think this is unfair?" really means "I think this is unfair." Restate the question as "I understand that you think this is unfair." Sometimes you may be able to use self-disclosure to diffuse the situation. In other words, state how you have felt in similar situations. Statements such as, "I know just how you feel," can be taken as patronizing. Rather, say, "I know how I've felt in situations like this."

5. Restate positive points

Once the initial emotional reaction has passed, help the person put the situation into perspective. You can help the person see the situation more positively by expressing confidence in his or her ability to meet the challenge and by providing genuine praise for efforts put forth. Reemphasize the basic facts about the situation and discuss any steps that can be taken to address the problem.

6. Offer assistance

If appropriate, you can offer to assist the person in future actions or planning. Do not offer to do something that you are not authorized to do. Inform the person that it may be necessary to submit revised plans and/or seek professional help.

7. Clearly express that violations must be corrected

An emotionally upset person may not be able to fully understand the situation or may intentionally misunderstand the conversation. Be sure that the person understands the information you have provided and knows what is expected to correct or address the situation. Repeat the actions that must be taken by all parties, and the required time frames. Discuss the required action. If you cannot change the requirements or time frames, tell the person that you regret that you cannot change them.

A good way to ensure that the person understands the information you have discussed is to ask the person to repeat the details of your discussion in his or her own words. For example, "I want to be sure I haven't said something that might be misunderstood. Would you tell me, in your own words, your understanding of this discussion?"

8. Allow for future contact and follow-up

Give the person a chance to contact you for further discussion. You may need to schedule a future meeting. You should always give the person your business card and phone numbers where you can be reached. Confirm, in writing, the conclusions

reached so that all parties have a similar basis for their understanding of the situation.

APPENDIX 9-B CONDUCT GUIDELINES AS A WITNESS

1. Before you testify, try to picture the scene, the objects there, the distances, and just what happened so that you can recall more accurately when you are asked. If the question is about distances or time, and your answer is only an estimate, be sure you say it is only an estimate.
2. A neat appearance and proper dress in court are important.
3. Avoid distracting mannerisms, such as chewing gum, while testifying. While taking the oath, stand upright, pay attention, and say "I do" clearly.
4. Don't try to memorize what you are going to say, because your testimony will not be as believable to the judge or jury if it is too "pat".
5. Be serious in the courtroom. Avoid laughing and talking about the case in the hallway or restrooms of the courthouse in such a way that a juror or defense witness or lawyer may see or overhear you.
6. Speak clearly and loudly enough so that the farthest juror can hear you easily. Remember to talk to the members of the jury, to look at the jurors and talk to them frankly and openly, as you would to any friend or neighbor.
7. Listen carefully to the questions asked of you. No matter how nice the attorney may seem on cross examination, he may be trying to hurt your testimony. Understand the question, have it repeated if necessary - then give a thoughtful, considered answer. Do not give a snap answer without thinking. You can't be rushed into answering (although, of course, it would look bad to take so much time on each question that the judge or jury would think you were making up an answer). Never answer a question you don't understand.
8. Explain your answer, if necessary. Give the answer in your own words, and if a question can't be truthfully answered with a "yes" or "no", you have a right to explain the answer.
9. Answer directly and simply only the question asked you, and then stop. Do not volunteer information not actually asked for.
10. If your answer was not correctly stated, correct it immediately. If your answer was not clear, clarify it immediately.
11. The judge and the jury are interested only in the facts. Therefore, don't give your conclusions and opinions.
12. Don't say "That's all of the conversation" or "Nothing else happened". Instead say, "That's all I recall", or "That's all I remember happening". It may be that after more thought or another question, you will remember something important.

13. Always be courteous, even if the lawyer questioning you may appear discourteous. Don't appear to be a cocky witness. This will lose you the respect of the judge and jury.
14. You are sworn to tell the truth. Tell it. Every material truth should be readily admitted, even if not to the advantage of the prosecution. Do not stop to figure out whether your answer will help or hurt your side. Just answer the questions to the best of your memory. Do not exaggerate.
15. Stop instantly when the judge interrupts you, or when an attorney objects to a question. Do not try to sneak your answer in.
16. Give positive, definite answers when at all possible. Avoid saying, "I think", "I believe", or "In my opinion", if you can be positive. If you do not know, say so. Don't make up an answer. You can be positive about important things, which you naturally would remember. If asked about little details which you would normally not remember, it is best just to say that you don't remember. But don't let the defense lawyer get you in a trap of answering question after question with "I don't know."
17. Try not to seem nervous. Avoid mannerisms which will make the judge or jury think you are scared, or not telling the truth or all that you know.
18. If you don't want to answer a question, don't ask the judge whether you must answer it. If it is an improper question, the Enforcement Attorney trying the case will take it up with the judge. Don't ask the judge for advice.
19. Don't look at the Enforcement Attorney or at the judge for help in answering a question. You are on your own. If the question is improper, the Enforcement Attorney will object. If the judge wants you to answer it, do so.
20. Do not "hedge" or argue with the defense attorney.
21. Do not nod your head for a "yes" or "no" answer. Speak so that the court reporter (or recording device) can hear the answer.
22. When you leave the witness stand after testifying, wear a confident expression, but don't smile or appear downcast.
23. Sometimes, not often, a defense attorney may ask a "trick question". For example, "Have you talked to anybody about this case?" If you say "No," the judge or jury knows that is incorrect because good prosecutors try to talk to witnesses before they take the stand. If you say, "Yes", the defense lawyer may try to infer that you have been told what to say. The best thing to do is to say very frankly that you have talked with whomever you have talked with -- Enforcement Attorney, victim, other witness, etc. -- and that you were just asked what the facts were. All that we want you to do is just to tell the truth as clearly as possible.

24. Above all -- this is most important -- **DO NOT LOOSE YOUR TEMPER.** Remember that some attorneys on cross examination will try to wear you out so you will lose your temper and say things that are not correct or that will hurt you or your testimony. **KEEP YOUR "COOL".**
25. Now, go back and re-read these suggestions so you will have them firmly in your mind. We hope they will help. These aren't to be memorized. If you remember that you are just talking to some neighbors on the jury, you will get along just fine.

Appendix 9-C Estimating Quantities

Stockpiles

Stockpiles can often be conveniently measured by calculating the volume of regular masses of similar outline, and making plus or minus adjustments for differences. A pile of clean dry sand may have a conical shape, or be a ridge with a triangular cross section, ending in half cones. Measurements should be taken to determine base size and height.

The area of the circular base of a cone is found approximately from the circumference by the formula:

$$\text{Area} = \frac{\text{Circumference}^2}{12.6}$$

and from half the diameter by:

$$\text{Area} = 3.14 \times \text{Radius}^2$$

The volume of a cone is the height times one third the base area. The long part of the pile is figured by the formula:

$$\text{Volume} = \frac{\text{Height} \times \text{Width} \times \text{Length}}{2}$$

A long pile will have the volume of the center section, plus the volume of one cone, as each of the ends is a half cone.

Excavated Pond

The volume of excavation required can be estimated with sufficient accuracy by use of the prismatic formula:

$$V = \frac{(A + 4B + C)}{6} \times \frac{D}{27}, \text{ where:}$$

V = Volume of excavation, in cubic yards.

A = Area of the excavation at the ground surface, in square feet.

B = Area of the excavation at the mid-depth point (1/2 D), in square feet

C = Area of the excavation at the bottom of the pond, in square feet.

D = Average depth of the pond, in feet

27 = Factor converting cubic feet to cubic yards.

Appendix 9-D Sample Check Lists

The example checklists provided can be a basis for creating specific checklists tailored for the specific duties and conditions of each public or private concern.

General Information

Some or all of the following information should appear on all checklists:

Project name
Permit number
Property parcel number
Name of inspector / reviewer
Name of design professional
Weather; or date and amount of last rain event

WARNING !

The checklist is an excellent tool for organizing yourself for an inspection or plan review. Like any other tool, the checklist can and will hurt you if not used properly! It is only a tool, not a substitute for the human mind. The checklist can lull you into a false sense of completeness and security. After using a checklist, ask yourself "Is there anything else? anything which is not covered in the checklist?" Periodically examine your checklists to make sure that they cover the issues which you encounter and that they stay current with any changing regulations or other conditions.

1. Plan Review

Narrative

Project description: A brief description of the nature and purpose of the land-disturbing activity and the amount of grading involved

Existing site conditions: A description of the existing topography, vegetation, and drainage

Adjacent areas: A description of neighboring areas, such as streams, lakes, residential areas, and roads that might be affected by the land disturbance

Soils: A brief description of the soils on the site including erodibility and particle size distribution

Critical areas: A description of areas within the developed site that have potential for serious erosion or sediment problems

Erosion and sediment control measures: A description of the methods that will be used to control erosion and sediment on the site

Permanent stabilization: A brief description of how the site will be stabilized after construction is completed

Maintenance: A schedule of regular inspections and repairs of erosion and sediment control structures

Site Plan or Map

Vicinity Map: A map which shows the project located within a larger region, including principle roads

North Arrow

Existing contours: Existing elevation contours of the site at an interval sufficient to determine drainage patterns

Preliminary and final contours: Proposed changes in the existing elevation contours for each stage of grading

Existing vegetation: Locations of trees, shrubs, grass, and unique vegetation

Soils: Boundaries of the different soil types within the proposed development

Critical areas: Areas within or near the proposed development with potential for serious erosion or sediment problems

Existing and final drainage patterns: A map showing the dividing lines and the direction of flow for the different drainage areas before and after development

Limits of clearing and grading: A line showing the area to be disturbed

Erosion and sediment control measures: Locations, names, and dimensions of the proposed temporary and permanent erosion and sediment control measures

Stormwater management system: Location of permanent storm drain inlets, pipes, outlets, and other permanent stormwater management facilities (swales, waterways, etc.); and sizes of pipes, channels, and structures

Details

Detailed drawings: Enlarged, dimensioned drawings of such key features as sediment basin risers, energy dissipators, and waterway cross sections

Seeding and mulching specifications: Seeding dates, seeding, fertilizing, and mulching rates in pounds per acre (kilograms per hectare), and application procedures

Maintenance program: Inspection schedule, spare materials needed, stockpile locations, and instructions for sediment removal and disposal and for repair of damaged structures

Calculations

Calculations and assumptions: Data for design storm used to size pipes and channels, and sediment basins and traps; design particle size for sediment traps and basins; estimated trap efficiencies; basin discharge rates; size and strength characteristics for filter fabric, wire mesh, fence posts, etc.; and other calculations necessary to support stormwater, erosion, and sediment control systems

2. Pre-construction Conference

Verify the following

Permits: Check that contractor / developer has all required permits, including, but not limited to: Federal, FDEP, FDOT, Water Management District, local or municipal, building permit if required.

Licenses: Get the name, license number, and type of license for all contractors involved in site development.

Contacts: Get the name, phone number, and mailing address of the property owner and all contractors involved in site development.

Special Conditions: Check for special conditions attached to any permits. This could be one of the most crucial aspects of the permit.

Discuss the following

Plans and scope of work: Be sure that the contractor understands the plans and the tasks to be performed.

Special Conditions: Point out that any special conditions are as valid and enforceable as the permit itself, they are not optional. Make sure that everything is clearly understood. Write down any unresolved issues and follow up quickly.

Erosion and sediment controls: Discuss the location, proper installation, and maintenance requirements of BMPs. Examine the erosion and sediment control details.

Buffers and natural areas must be protected: Discuss the methods used to protect these areas. Be sure that they will not be used for parking, portable toilets, material storage, waste disposal, or other unintended uses.

Tree Protection: Verify the location and type of protected trees which will remain. Discuss protection requirements and methods. Be sure that protected areas will not be used for parking, etc.

Construction sequencing: The construction sequence will be enforced. Perimeter controls, sediment traps and basins, and necessary conveyances will be installed and stabilized **before** the rest of the site is cleared.

Performance oriented regulations: Be sure that the contractor understands that the site will be out of compliance if erosion and sediment controls fail, even if everything has been done according to plan. In that event additional measures will be required.

Plan Changes: Construction will not be allowed which differs from the plans. Major changes to the erosion and sediment control plan. Any changes to the site development plan will require re-approval. Minor changes to the erosion and sediment control plan must be approved by the inspector.

Routine Inspections: Advise the contractor that you will be monitoring this site for proper installation and diligent maintenance of BMPs.

Final Inspection: A final inspection will be performed when all permitted improvements have been completed. Inform the contractor about the documents which will be required at that time (i.e., Operating permit, Post-construction certification, As-built drawings, etc.).

Inspect the site: Walk or drive around the site with the contractor. Point out any potential problems on- or off-site. Tell the contractor what you will be looking for on your next inspections.

Affirmation: Provide the owner /contractor with a copy of your check list and make sure again that everything has been discussed and clearly understood. Note any clarifications, agreements, and unresolved issues. Sign and date all copies and have them do the same.

3. Routine Inspection - Maintenance Inspection

Control measure	Problems to look for	Possible remedies
Vegetation	Rills or gullies forming	Check for top-of-slope diversion and install if needed.
	Bare soil patches	Fill rills and regrade gullied slopes, revegetate.
	Sediment at toe of slope	Remove sediments, revegetate using site appropriate methods.
Berms	Gully on slope below dike breach; wheel track or low spot in dike	Add soil to breaches or low spots and compact.
	Loose soil	Compact loose soil.
	Erosion of berm face	Line upslope face with riprap, or revegetate using site appropriate methods.
Swales	Gully on slope below swale	Repair breaches.
	Wheel track, low point (water ponded in swale)	Build up low areas with compacted soil or sandbags or rebuild swales w/ positive slope.
	Sediment or debris in channel	Remove obstructions.

Swales (continued)	Erosion of unlined channel surface	Mulch and install anchored sod or erosion control blanket; or line swale w/ riprap; or install check dams; or realign swale on gentler gradient; or divert some or all stormwater to a more stable facility.
	Erosion of channel lining	Install larger riprap; or reseed, mulch, and anchor w/ netting; or install check dams; or pave swale
Pipe slope drain or flume	Blocked inlet or outlet	Remove sediment and debris.
	Runoff bypassing inlet	Enlarge headwall or flare out entrance section.
	Erosion at outlet	Enlarge riprap apron and use larger riprap; or convey runoff to a more stable outlet.
Grassed waterways	Bare areas	Revegetate w/ anchored sod or erosion control blanket; divert flow during establishment period.
	Channel capacity reduced by tall growth	Mow grass
Riprap lined waterway	Scour beneath stones	Install proper geotextile or graded bedding. Make sure edges of geotextile are buried.
	Dislodged stones	Replace w/ larger stones.
Outlet protection	Erosion below outlet	Enlarge riprap apron; or line receiving channel below outlet; or convey runoff directly to a more stable outlet. make sure discharge point is on level or nearly level grade.
	Outlet scour	Install proper geotextile or graded bedding beneath riprap apron.

Outlet protection (continued)	Dislodged stones	Replace w/ larger stones.
Sediment traps and basins	Sediment level near outlet elevation	In traps, remove sediment if less than 1 ft.(0.3 m) below outlet elevation; in basins, remove sediments if less than 2 ft.(0.6 m) below top of riser.
	Obstructed outlet	Remove debris from trash rack.
	Basin not dewatering between storms	Clear holes. Clean or replace sediment-choked gravel surrounding dewatering hole or subsurface drain.
	Damaged embankments	Rebuild and compact damaged areas.
	Spillway erosion	Line spillway w/ rock, geotextile, or pavement.
	Outlet erosion	Make sure outlet is flush w/ ground and on level grade. Install, extend or repair riprap apron as required; or convey discharge directly to a more stable outlet.
	Riser flotation	Anchor riser in concrete footing.
	Excessive discharge to and from basin or trap	Check runoff patterns for consistency w/ plans. Reroute part of volume to another basin or enlarge the basin.
	Sediment storage zone fills too quickly.	Increase size of basin; or stabilize more of the contributing area.
Silt fence	Undercutting of fence	Entrench wire mesh and fabric to proper depth, backfill, and compact.

Silt fence (continued)	Fence collapsing	Check post size and spacing, gauge of wire mesh and fabric strength. Check drainage area, slope length and gradient behind barrier. Correct any substandard condition.
	Torn fabric	Replace w/ continuous piece of fabric from post to post, attach w/ proper staples.
	Runoff escaping around fence	Extend fence.
	Sediment level near top of fence	Remove sediment when level reaches half of fence height.
Check dam	Sediment accumulation	Remove sediment after each storm.
	Flow escaping around sides of check dam	Build up ends of dam and provide low center area for spillway.
	Displacement of sandbags, stones, or straw bales	Check drainage areas and peak flows. Reinforce dam w/ larger stones, etc.; or divert part of flow to another outlet.
Inlet protection	Flooding around or below inlet	Remove accumulated sediment; or convert sediment barrier to an excavated sediment trap; or reroute runoff to a more suitable area.
	Undercutting of bales or silt fence, bale displacement, torn fabric, etc.	See remedies for straw bale barriers and silt fences.

4. Final Inspection

General

Are all Final Inspection documents in order (As-Built drawings, Compliance Report, Post-construction Certification, Operating Permit, etc.)?
Are all applicable easements recorded with the Clerk of the Court?
Are the roads, buildings, parking, sidewalks, etc. as shown on plans?
Is there any significant change in impervious area?
Did natural or undisturbed areas remain that way?
Are all utilities installed (not necessarily hooked-up)?
Are there any outstanding violations or fees?
Is there any off-site disturbance or adverse impact from this project?

Stormwater Facilities

Is the stormwater management facility (pond or ponds) where it should be?
If the facility is underground, is there access for maintenance?
Is the facility the size and depth it should be?
Are the slopes as shown on plans and stabilized?
If applicable, is the stormwater facility fenced?
Are the control structures as shown and clean?
Is the filter system as shown and clean?
Are energy dissipators as shown and stabilized?
Is the pond bottom free of sediments?
Are aquatic plantings installed as shown and in good condition?
Does the facility meet minimum performance standards as permitted (treatment and volume recovery)?

Stormwater Conveyance

Is the conveyance system as shown and free of debris, stabilized?
Are all inlets as shown and clean?
Are roof drains as shown?
Is all water on site directed to ponds, except accessways?

Landscaping/Natural Areas

Are natural buffers existing and undisturbed?
If buffers were to be augmented, have they been?
Is uncomplimentary land use buffer, if applicable, as shown and planted or fenced to meet permit/code requirements?
Can buffer areas be accessed for maintenance?
Are landscape islands in parking areas as shown?
Is perimeter landscaping as shown?
Are all landscape areas protected by curbing, wheel stops, or other physical barrier?
Do all landscape areas have access to irrigation?
Do all plantings conform to the approved landscape schedule?
Are all seeded areas firmly established?
Is all sod firmly established, properly anchored?

Tab
Insert

REFERENCES

- American National Standards Institute. *A300 Best management practices – Pruning*.
- Caltrans (State of California, Department of Transportation). 2003. *California stormwater BMP handbook (construction)*. Available: <http://www.cabmphandbooks.com/Documents/Construction/Construction.pdf>.
- . 2006. *Management of construction site dewatering operations, Districts 1–12*. Caltrans Course No. G0C095. CTSW-OT-06-137.17.2. Available: <http://www.dot.ca.gov/hq/construc/stormwater/dewateringclass.pdf>.
- . Main Website. Available: <http://www.dot.ca.gov>.
- Delaware Technical and Community College, Terry Campus. 1991. *Sediment and stormwater management certified construction reviewer course*. Dover, Delaware.
- Florida Administrative Code. Available: <https://www.flrules.org/Default.asp>.
- Florida Department of Environmental Protection. April 2006. *Florida erosion and sediment control inspector's manual*. Sixth impression. Tallahassee, Florida.
- . *Generic permit for the discharge of produced ground water from any non-contaminated activity (generic permit)*. Available: [http://www.dep.state.fl.us/legal/rules/shared/62-21\(2\).doc](http://www.dep.state.fl.us/legal/rules/shared/62-21(2).doc)
- . *Save the swales* (pamphlet). Available: <http://www.dep.state.fl.us/water/nonpoint/docs/nonpoint/sts.pdf>
- . Nonpoint Source Management Program Website. Available: <http://www.dep.state.fl.us/water/nonpoint/index.htm>.
- . Rules Website. Available: <http://www.dep.state.fl.us/legal/rules/rulelistnum.htm>.
- . Environmental Resource Permitting Website. Available: <http://www.dep.state.fl.us/water/wetlands/erp/index.htm>.
- . Program for Municipal Separate Storm Sewer Systems (MS4s) Website. Available: http://www.dep.state.fl.us/water/stormwater/npdes/MS4_1.htm.
- Florida Department of Environmental Regulation. 1988. *The Florida development manual: A guide to sound land and water management*. Tallahassee, Florida. Available: http://www.dep.state.fl.us/water/nonpoint/docs/nonpoint/eroded_bmp.pdf.
- Florida Water Management Districts Permitting Portal Website. Available: <http://flwaterpermits.com>.
- Florida Statutes. Available: <http://www.leg.state.fl.us/statutes/>.
- Goldman, S.J., K. Jackson, and T.A. Bursztynsky. 1986. *Erosion and sediment control handbook*. New York: McGraw-Hill, Inc.
- Harris, Clark, and Matheny. 1999. *Arboriculture: Integrated Management of Landscape, Trees, Shrubs, and Vines*. Upper Saddle River, NJ: Prentice Hall.
- Matheny and Clark, 1998. *Trees and Development: A Technical Guide to Preservation of Trees During Land Development*. Champaign, IL: International Society of Arboriculture.

REFERENCES

- Minnesota Erosion Control Association. 2006. Available: <http://www.mnerosion.org>.
- Montgomery County, Maryland. 1992. *Trees: Approved technical manual*. Available: http://www.mc-mncppc.org/environment/forest/trees/toc_trees.shtm
- Natural Resources Conservation Service Website. Available: <http://soils.usda.gov/>.
- North Carolina Sedimentation Control Commission. 1988. *Erosion and sediment control planning and design manual*. Raleigh, North Carolina.
- Pirone, P.P. 1979. *Tree maintenance*.
- Seibert, P. 1968. Importance of natural vegetation for the protection of the banks of streams, rivers, and canals. In: *Freshwater, Council of Europe, Nature and Environment Series*.
- Southwest Florida Water Management District. March 1988. *Management and storage of surface waters: Permit information manual, Vol. 1*.
- Thelen, E. et al. March 1972. *Investigation of porous pavements for urban runoff control*. Water Pollution Control Research Series: 11034 DUY. U.S. Environmental Protection Agency.
- UltraTech International, Inc. 2006. *Compliance products for stormwater management*. Available: <http://www.spillcontainment.com>.
- University of Florida, Institute of Food and Agricultural Sciences. 2008. Landscape Plants Website. Available: <http://hort.ifas.ufl.edu/woody/maintenance.html> and <http://hort.ifas.ufl.edu/woody/palms.html>.
- U.S. Environmental Protection Agency Website. Available: <http://www.epa.gov/region5/water/cwa.htm>.
- Virginia Department of Transportation. 2002. *Drainage manual*. Available: <http://virginiadot.org/business/locdes/hydra-drainage-manual.asp>.
- . *Road designs and standards*. 2001. Available: <http://virginiadot.org/business/locdes/road-and-bridge-standards.asp>.
- . 2001 (revised February 2008). *Standard sheets*. Available: http://virginiadot.org/business/locdes/Standard_Insertable.asp.

Best Management Practices (BMPs) For Erosion And Sediment Control

NAME	APPLICATION	MAX DRAINAGE AREA	USEFUL LIFE	COMMENT
Block & Gravel	Inlet Protection	< 1 Acre	3-6 Months	Routine Maintenance Required
Brush Barrier	Perimeter Control	Unspecified	3-6 Months	Routine Maintenance Required
Check Dam / Hay Bale	Control Water Velocity	10 Acres	< 3Months	Replace As Needed
Check Dam / Rock (Gravel)	Control Water Velocity	10 Acres	18 Months	Max Height 2 feet
Check Dam / Silt Fence	Control Water Velocity	10 Acres	6 Months	Replace As Needed
Construction Road Stabilization	Road Stabilization	Unspecified	Project Life	Routine Maintenance Required
Curb & Gutter Sediment Barrier	Inlet Protection	< 1 Acre	> 6 Months	Routine Maintenance Required
Drainfield Pipe Inlet Protection	Inlet Protection	< 1 Acre	> 6 Months	Routine Maintenance Required
Floating Turbidity Barrier	Silt/Sediment Containment	Unspecified	>18 Months	Use in Low Flow Water Body
GeoHay Curb Inlet Protection	Inlet Protection	< 1 Acre	> 6 Months	Routine Maintenance Required
Gravel & Wire Mesh	Inlet Protection	< 1 Acre	3-6 Months	Routine Maintenance Required
Hay Bale (Straw Bale)	Perimeter Control	< 1/4 Acre per 100 ft. of length	3 Months	Check for Invasive Weeds
Hay Bale (Straw Bale)	Inlet Protection	< 1 Acre	3 Months	Routine Maintenance Required
Silt Fence	Perimeter Control	< 1/4 Acre per 100 ft. of length	6 Months	Trench In & Compact
Silt Fence (Filter Fabric)	Inlet Protection	< 1 Acre	3 Months	Routine Maintenance Required
Sod	Inlet Protection	< 1 Acre	> 6 Months	Routine Maintenance Required
Temporary Diversion Dike	Slope Protection	5 Acres	>18 Months	Compact / Stabilize Slopes
Temporary Fill Diversion	Slope Protection	5 Acres	1 Day-1 Week	Rebuild As Needed
Temporary Gravel Construction Entrance	Entrance	Unspecified	Project Life	Routine Maintenance Required
Temporary Sediment Basin	Sediment Removal	> 5 Acres	18 Months	Engineer Must Design
Temporary Sediment Trap	Sediment Removal	5 Acres	18 Months	Stabilize Interior/Exterior Slopes
Temporary Slope Drain	Slope Protection	5 Acres	3-6 Months	Stabilize Outfall
Temporary Right-Of-Way Diversion	Shorten Flow Length	< 5 Acres	3-6 Months	Inspect Weekly Or After Rain

GLOSSARY OF TERMS

The list of terms that follows is representative of those used by soil scientists, engineers, developers, conservationist planners, etc. The terms are not necessarily used in the text, nonetheless they are in common use in conservation matters. This glossary was compiled from definitions supplied by the Soil Conservation Service, Soil Conservation Society of America Resource Conservation Glossary, and other state, federal, and private publications.

Glossary

AASHTO CLASSIFICATION (soil engineering) -- The official classification of soil materials and soil aggregate mixtures for highway construction used by the American Association of State Highway Transportation Officials.

ACID SOIL -- A soil with a preponderance of hydrogen ions, and probably of aluminum in proportion to hydroxyl ions. Specifically, soil with a pH value less than 7.0. For most practical purposes, a soil with a pH value less than 6.6. The pH values obtained vary greatly with the method used; consequently, there is no unanimous agreement on what constitutes an acid soil. The term is usually applied to the surface layer or to the root zone unless specified otherwise.

ACRE-FOOT -- The volume of water that will cover 1 acre to a depth of 1 foot.

ACTIVE FRACTION -- The component of the soil having an ion exchange capacity, specifically clay and organic matter.

ADSORB -- Collect and adhere relatively loosely on a surface.

AEOLIAN -- Wind borne.

AGGRADATION -- The process of building up a surface by deposition. This is a long-term or geologic trend in sedimentation

ALKALINE SOIL -- A soil that has pH greater than 7.0, particularly above 7.3, throughout most or all of the root zone, although the term is commonly applied to only the surface layer or horizon of a soil.

ALLUVIAL -- Pertaining to material that is transported and deposited by running water.

ALLUVIAL LAND -- Areas of unconsolidated alluvium, generally stratified and varying widely in texture, recently deposited by streams, and subject to frequent flooding. A miscellaneous land type.

ALLUVIAL SOILS -- An axonal great soil group of soils, developed from transported and recently deposited material (alluvium) characterized by a weak modification (or none) of the original material by soil forming processes

ALLUVIUM -- A general term for all detrital material deposited or in transit by streams, including gravel, sand, silt, clay, and all variations and mixtures of these. Unless otherwise noted, alluvium is unconsolidated.

ANGLE OF REPOSE -- Angle between the horizontal and the maximum slope that a soil assumes through natural processes.

ANTECEDENT SOIL WATER -- Degree of wetness of a soil prior to irrigation or at the beginning of a runoff period, expressed as an index or as total inches soil water.

ANTI-SEEP COLLAR -- A device constructed around a pipe or other conduit and placed through a dam, levee, or dike for the purpose of reducing seepage losses and piping failures.

ANTI-VORTEX DEVICE -- A facility placed at the entrance to a pipe conduit structure such as a drop inlet spillway or hood inlet spillway to prevent air from entering the structure when the pipe is flowing full.

APRON (soil engineering) -- A floor or lining to protect a surface from erosion. An example is the pavement below chutes, spillways, or at the toes of dams.

AUXILIARY SPILLWAY -- A dam spillway built to carry runoff in excess of that carried by the principal spillway. See Emergency Spillway.

BACKFILL -- The material used to refill a ditch or other excavation, or the process of doing so.

BEDROCK -- The solid rock underlying soils and the regolith in depths ranging from zero (where exposed by erosion) to several hundred feet.

BEDLOAD -- The sediment that moves by sliding, rolling, or bounding on or very near the streambed; sediment moved mainly by tractive or gravitational forces or both but at velocities less than the surrounding flow.

BLINDING MATERIAL -- Material placed on top and around a closed drain to improve the flow of water to the drain and to prevent displacement during backfilling of the trench.

BLIND INLET -- Inlet to a drain in which entrance of water is by percolation rather than open flow channels.

BORROW AREA -- A source of earth fill material used in the construction of embankments or other earth fill structures.

BOTTOM LANDS -- A term often used to define lowlands adjacent to streams.

BOX-CUT -- The initial cut driven in a property where no open side exists, resulting in a highwall on both sides at the cut.

BRUSH MATTING --

- (1) A matting of branches placed on badly eroded land to conserve moisture and reduce erosion while trees or other vegetative covers are being established.
- (2) A matting of mesh wire and brush used to retard streambank erosion.

CALCAREOUS -- Soil or rock material with high calcium carbonate content.

CHANNEL -- A natural stream that conveys water; a ditch or channel excavated for the flow of water. See Watercourse.

Glossary

CHANNEL IMPROVEMENT -- The improvement of the flow characteristics of a channel by clearing, excavation, realignment, lining, or other means in order to increase its capacity. Sometimes used to connote channel stabilization.

CHANNEL STABILIZATION -- Erosion prevention and stabilization of velocity distribution in a channel using jetties, drops, revetments, vegetation, and other measures.

CHANNEL STORAGE -- Water temporarily stored in channels while enroute to an outlet.

CLAY --

- (1) Particle size less than 0.002 mm.
- (2) Soil containing more than 45 percent clay, less than 40 percent silt, and less than 45 percent sand.

COLLOID -- In soil, organic or inorganic matter having very small particle size and a correspondingly large surface area per unit of mass. Most colloidal particles are too small to be seen with the ordinary compound microscope.

COLLUVIUM -- a deposit of rock fragments and soil material accumulated at the base of steep slopes as a result of gravitational action.

COMPACTION -- In soil engineering, the process by which the silt grains are rearranged to decrease void space and bring them into closer contact with one another, thereby increasing the weight of solid material per cubic foot.

CONDUIT -- Any channel intended for the conveyance of water, whether open or closed.

CONSERVATION -- The protection, improvement, and use of natural resources according to principles that will assure their highest economic or social benefits.

CONSERVATION DISTRICT -- A public organization created under state enabling law as a special purpose district to develop and carry out a program of soil, water, and related resource conservation, use, and development within its boundaries; usually a subdivision of state government with a local governing body. Often called a soil conservation district or a soil and water conservation district.

CONTOUR --

- (1) An imaginary line on the surface of the earth connecting points of the same elevation.
- (2) A line drawn on a map connecting points of the same elevation.

COVER CROP -- A close-growing crop grown primarily for the purpose of protecting and improving soil between periods of permanent vegetation.

CRADLE -- A device, usually concrete, used to support a pipe conduit or barrel.

CREEP (SOIL) -- Slow mass movement of soil and soil material down relatively steep slopes, primarily under the influence of gravity, but facilitated by saturation with water and by alternate freezing and thawing.

CRITICAL AREA -- A severely eroded sediment producing area that requires special management to establish and maintain vegetation in order to stabilize soil conditions.

CUT -- A portion of land surface or area from which earth has been removed or will be removed by excavation; the depth below original ground surface to excavated surface. Syn. Excavation.

CUT-AND-FILL -- Process of earth moving by excavating part of an area and using the excavated material for adjacent embankments or fill areas.

CUTOFF -- A wall, collar or other structure, such as a trench; filled with relatively impervious material intended to reduce seepage of water through porous strata.

DAM -- A barrier to confine or raise water for storage or diversion, to create a hydraulic head, to prevent gully erosion, or for retention of soil, rock, or other debris.

DEBRIS -- The loose material arising from the disintegration of rocks and vegetative material; transportable by streams, ice, or floods.

DEBRIS DAM -- A barrier built across a stream channel to retain rock, sand, gravel, silt, or other material.

DEBRIS GUARD -- A screen or grate at the intake of a channel, drainage, or pump structure for the purpose of stopping debris.

DEGRADATION -- To wear down by erosion, especially through stream action.

DESIGN HIGH WATER -- The elevation of the water surface as determined by the flow conditions of the design floods.

DESIGN LIFE -- The period of time for which a facility is expected to perform its intended function.

DESILTING AREA -- An area of grass, shrubs, or other vegetation used for inducing deposition of silt and other debris from flowing water; located above a stock tank, pond, field, or other area needing protection from sediment accumulation. See Filter Strip.

DETENTION -- The practice of temporarily storing runoff prior to its' gradual release, usually not greater than the pre-development discharge rate.

DETENTION DAM -- A dam constructed for the purpose of temporary storage of streamflow or surface runoff and for releasing the stored water at controlled rates.

Glossary

DIKE (engineering) -- An embankment to confine or control water, especially one built along the banks of a river to prevent overflow of lowlands; a levee. (geology)--A tabular body of igneous rock that cuts across the structure of adjacent rocks or cuts massive rocks.

DISCHARGE (hydraulics) -- Rate of flow, specifically fluid flow; a volume of fluid passing a point per unit time, commonly expressed as cubic feet per second, million gallons per day, gallons per minute, or cubic meters per second.

DISCHARGE COEFFICIENT (hydraulics) -- The ratio of actual rate of flow to the theoretical rate of flow through orifices, weirs, or other hydraulic structures.

DISCHARGE FORMULA (hydraulics) -- A formula to calculate rate of flow of fluid in a conduit or through an opening. For steady flow discharge, $Q = AV$, wherein **Q** is rate of flow, **A** is cross-sectional area, and **V** is mean velocity. Common units are cubic feet per second, square feet, and feet per second, respectively. To calculate the mean velocity, **V** for uniform flow in pipes or open channels, see Manning's Formula.

DISPERSION, SOIL -- The breaking down of soil aggregates into individual particles, resulting in single-grain structure. Ease of dispersion is an important factor influencing the erodibility of soils. Generally speaking, the more easily dispersed the soil, the more erodible it is.

DIVERSION -- A channel with or without a supporting ridge on the lower side constructed across the top or at the bottom of a slope for the purpose of intercepting surface runoff.

DIVERSION DAM -- A barrier built to divert part or all of the water from a stream into a different course.

DRAIN --

- (1) A buried pipe or other conduit (closed drain).
- (2) A ditch (open drain) for carrying off surplus surface water or groundwater.
- (3) To provide channels, such as open ditches or closed drains, so that excess water can be removed by surface flow or by internal flow.
- (4) To lose water (from the soil) by percolation.

DRAINAGE --

- (1) The removal of excess surface water or groundwater from land by means of surface or subsurface drains.
- (2) Soil characteristics that affect natural drainage.

DRAINAGE, SOIL -- As a natural condition of the soil, soil drainage refers to the frequency and duration of periods when the soil is free of saturation; for example, in well-drained soils the water is removed readily but not rapidly; in poorly drained soils the root zone is waterlogged for long periods unless artificially drained, and the roots of ordinary crop plants cannot get enough oxygen; in excessively drained soils the water

is removed so completely that most crop plants suffer from lack of water. Strictly speaking, excessively drained soils are a result of excessive runoff due to steep slopes or low available water holding capacity due to small amounts of silt and clay in the soil material. The following classes are used to describe soil drainage:

WELL DRAINED -- excess water drains away rapidly and no mottling occurs within 36 inches of the surface.

MODERATELY WELL DRAINED -- water is removed from the soil somewhat slowly, resulting in small but significant periods of wetness. Mottling occurs between 18 and 36 inches.

SOMEWHAT POORLY DRAINED -- water is removed from the soil slowly enough to keep it wet for significant periods but not all of the time. Mottling occurs between 8 and 18 inches.

POORLY DRAINED -- water is removed so slowly that the soil is wet for a large part of the time. Mottling occurs between 0 and 8 inches.

VERY POORLY DRAINED -- water is removed so slowly that the water table remains at or near the surface for the greater part of the time. There may also be periods of surface ponding. The soil has a black to gray surface layer with mottles up to the surface.

DRAWDOWN -- Lowering of the water surface (in open channel flow), water table, or piezometric surface (in groundwater flow) resulting from a withdrawal of water.

DROP-INLET SPILLWAY -- Overfall structure in which the water drops through a vertical riser connected to a discharge conduit.

DROP SPILLWAY -- Overfall structure in which the water drops over a vertical wall onto an apron at a lower elevation.

DROP STRUCTURE -- A structure for dropping water to a lower level and dissipating its surplus energy; a fall. A drop may be vertical or inclined.

EARTH DAM -- Dam constructed of compacted soil material.

EMBANKMENT -- A man-made deposit of soil, rock, or other material used to form an impoundment.

EMERGENCY SPILLWAY -- A spillway used to carry runoff exceeding a given design flood. Syn. Auxiliary Spillway.

ENERGY DISSIPATOR -- A device used to reduce the energy of flowing water.

ERODIBLE (geology and soils) -- Susceptible to erosion.

Glossary

EROSION --

- (1) The wearing away of the land surface by running water, wind, ice, or other geological agents, including such processes as gravitational creep.
- (2) Detachment and movement of soil or rock fragments by water, wind, ice, or gravity. The following terms are used to describe different types of water erosion:

ACCELERATED EROSION -- Erosion much more rapid than normal, or geologic erosion, primarily as a result of the influence of the activities of man, or in some cases, of other animals or natural catastrophes that expose base surfaces, for example, fires.

GEOLOGICAL EROSION -- The normal or natural erosion caused geological processes acting over long geologic periods and resulting in the wearing away of mountains, the building up of floodplains, coastal plains, etc. See Natural Erosion.

GULLY EROSION -- The erosion process whereby water accumulates in narrow channels and, over short periods, removes the soil from this narrow area to considerable depths, ranging from 1 to 2 feet to as much as 75 to 100 feet.

NATURAL EROSION -- Wearing away of the earth's surface by water, ice, or other natural agents under natural environmental conditions of climate, vegetation, etc.; undisturbed by man. See Geological Erosion.

NORMAL EROSION -- The gradual erosion of land used by man which does not greatly exceed natural erosion. See Natural Erosion.

RILL EROSION -- An erosion process in which numerous small channels only several inches deep are formed; occurs mainly on recently disturbed and exposed soils. See Rill.

SHEET EROSION -- The removal of a fairly uniform layer of soil from the land surface by runoff water.

SPLASH EROSION -- The spattering of small soil particles caused by the impact of rain drops on wet soils. The loosened and spattered particles may or may not be subsequently removed by surface runoff.

EROSION AND SEDIMENTATION CONTROL PLAN -- A plan for the control of erosion and sedimentation resulting from a land-disturbing activity.

EROSION CLASSES (soil survey) -- A grouping of erosion conditions based on the degree of erosion or on characteristic patterns; applied to accelerated erosion, not to normal, natural, or geological erosion. Four erosion classes are recognized for water erosion and three for wind erosion.

EROSION INDEX -- An interaction term of kinetic energy times maximum 30-minute rainfall intensity that reflects the combined potential of raindrop impact and turbulence of runoff to transport dislodged soil particles from a field.

EROSIVE -- Having sufficient velocity to cause erosion; refers to wind or water. Not to be confused with erodible as a quality of soil.

ESCARPMENT -- A steep face or a ridge of high land; the escarpment of a mountain range is generally on that side nearest the sea.

EXCHANGE CAPACITY -- Interchange between an ion in solution and another ion on the surface of any surface-active material such as a clay or organic colloid.

EXISTING GRADE -- The vertical location of the existing ground surface prior to cutting or filling.

FERTILIZER -- Any organic or inorganic material of natural or synthetic origin that is added to a soil to supply elements essential to plant growth.

FERTILIZER ANALYSIS -- The percentage composition of fertilizer, expressed in terms of nitrogen, phosphoric acid, and potash. For example, a fertilizer with a 6-12-6 analysis contains 6 percent nitrogen (N), 12 percent available phosphoric acid (P_2O_5) and 6 percent water-soluble potash (K_2O). Minor elements may also be included. Recent analysis expresses the percentages in terms of the elemental fertilizer (nitrogen, phosphorus, potassium).

FILLING -- The placement of any soil or other solid material either organic or inorganic on a natural ground surface or an excavation.

FILTER STRIP -- A long, narrow vegetative planting used to retard or collect sediment for the protection of diversions, drainage basins or other structures.

FINAL CUT -- The last cut or line of excavation made when mining a specific property or area.

FINISHED GRADE -- the final grade or elevation of the ground surface forming proposed design.

FLOOD -- An overflow or inundation that comes from a river or other body of water and causes or threatens damage.

FLOOD CONTROL -- Methods or facilities for reducing flood flows.

FLOOD CONTROL PROJECT -- A structural system installed for protection of land and other improvements from floods by the construction of dikes, river embankments, channels, or dams.

Glossary

FLOODGATE -- A gate placed in a channel or closed conduit to keep out floodwater or tidal backwater.

FLOOD PEAK -- The highest value of the stage or discharge attained by a flood. The peak stage or peak discharge.

FLOODPLAIN -- Nearly level land situated on either side of a channel which is subject to overflow flooding.

FLOOD ROUTING -- Determining the changes in the rise and fall of floodwater as it proceeds downstream through a valley or reservoir.

FLOOD STAGE -- The stage at which overflow of the natural banks of a stream begins to cause damage in the reach in which the elevation is measured.

FLOODWATER RETARDING STRUCTURE -- A Structure providing for temporary storage and controlled release of floodwater.

FLOODWAY -- A channel, either natural, excavated, or bounded by dikes and levees, used to carry excessive flood flows to reduce flooding; sometimes considered to be the transitional area between the active channel and the floodplain.

FLUME -- A device constructed to convey water on steep grades lined with erosion resistant materials.

FRAGIPAN -- A natural subsurface horizon with high bulk density relative to the soil above, seemingly cemented when dry but showing a moderate to weak brittleness when moist. The layer is low in organic matter, mottled, slowly or very slowly permeable to water, and usually shows occasional or frequent bleached cracks forming polygons. It may be found in profiles of either cultivated or virgin-soils but not in calcareous material.

FREEBOARD (hydraulics) -- Vertical distance between the maximum water surface elevation anticipated in design and the top of retaining banks or structures provided to prevent overtopping because of unforeseen conditions.

GAGE OR GAUGE -- Device for registering precipitation, water level, discharge, velocity, pressure, temperature, etc.

GAGING STATION -- A selected section of a stream channel equipped with a gage, recorder, or other facilities for determining stream discharge.

GRADATION (geology) -- The bringing of a surface or a stream bed to grade by running water. As used in connection with sedimentation and fragmental products for engineering evaluation, the term gradation refers to the frequency distribution of the various sized grains that constitute a sediment, soil, or material.

GRADE --

- (1) The slope of a road, channel, or natural ground.
- (2) The finished surface of a canal bed, roadbed, top of embankment, or bottom of excavation; any surface prepared for the support of construction like paving or laying a conduit.
- (3) To finish the surface of a canal bed, roadbed, top of embankment, or bottom of excavation.

GRADED STREAM -- A stream in which, over a period of years, the slope is delicately adjusted to provide, with available discharge and with prevailing channel characteristics, just the velocity required for transportation of the load (of sediment) supplied from the drainage basin. The graded profile is a slope of transportation. It is a phenomenon in which the element of time has a restricted connotation. Works of man are limited to his experience and of design and construction.

GRADE STABILIZATION STRUCTURE -- A structure for the purpose of stabilizing the grade of a gully or other watercourse, thereby preventing further headcutting or lowering of the channel grade.

GRADIENT -- Change of elevation, velocity, pressure, or other characteristics per unit length; slope.

GRADING -- Altering surfaces to specified elevations, dimensions, and/or slopes; this includes stripping, cutting, filling, stockpiling, and shaping, or any combination thereof; and shall include the land in its cut or filled condition.

GRASS -- A member of the botanical family ***Gramineae***, characterized by bladelike leaves arranged on the culm or stem in two ranks.

GRASSED WATERWAY -- A natural or constructed waterway, usually broad and shallow, covered with erosion-resistant grasses, used to conduct surface water from cropland.

GULLY -- A channel or miniature valley cut by concentrated runoff but through which water commonly flows only during and immediately after heavy rains or during the melting of snow. A gully may be dendritic or branching; or it may be linear, rather long, narrow, and of uniform width. The distinction between gully and rill is one of depth. A gully is sufficiently deep that it would not be obliterated by normal tillage operations, whereas a rill is of lesser depth and would be smoothed by use of ordinary tillage equipment. See Erosion, Rill.

GULLY EROSION -- See Erosion.

GULLY CONTROL PLANTINGS -- The planting of forage, legume, or woody plant seeds, seedlings, cuttings, or transplants in gullies to establish or reestablish a vegetative cover adequate to control runoff and erosion and incidentally produce useful products.

Glossary

HABITAT -- The environment in which the life needs of a plant or animal organism, population or community are supplied.

HEAD (hydraulics) --

- (1) The height of water above any plane of reference.
- (2) The energy, either kinetic or potential, possessed by each unit weight of a liquid, expressed as the vertical height through which a unit weight would have to fall to release the average energy possessed; used in various compound terms such as pressure head, velocity head, and lost head.
- (3) The internal pressure expressed in feet, or pounds per square inch, of an enclosed conduit.

HEADGATE -- Water control structure; the gate at the entrance to a conduit.

HEAD LOSS -- Energy loss due to friction, eddies, changes in velocity, or direction of flow. Syn. friction head.

HEADWATER --

- (1) The source of stream.
- (2) The water upstream from a structure or point on a stream.

HOOD INLET -- Entrance to a closed conduit that has been shaped to induce full flow at minimum water surface elevation.

HYDROGRAPH -- A graph showing variation in stage (depth) or discharge of a stream of water over a period of time.

IGNEOUS ROCK -- Rock formed from the cooling and solidification of molten rock, and that has not been changed appreciably since its formation.

IMPOUNDMENT -- Generally, an artificial collection or storage of water, as a reservoir, pit, dugout, sump, etc. Syn. reservoir.

INFILTRATION -- The gradual downward flow of water from the surface through soil to groundwater and water table reservoirs.

INFILTRATION RATE -- A soil characteristic determining or describing the maximum rate at which water can enter the soil under specified conditions, including the presence of an excess of water.

INLET (hydraulics) --

- (1) A surface connection to a closed drain.
- (2) A structure at the diversion end of a conduit.
- (3) The upstream end of any structure through which water may flow.

INOCULATION -- The process of introducing pure or mixed cultures of micro-organisms into natural or artificial cultural media.

INTAKE --

- (1) The headworks of a conduit, the place of diversion.
- (2) Entry of water into soil. See Infiltration.

INTAKE RATE -- The rate of entry of water into soil. See Infiltration Rate.

INTENSITY -- Rainfall rate, usually expressed in inches / hour.

INTERCEPTION (hydraulics) -- The process by which precipitation is caught and held by foliage, twigs, and branches of trees, shrubs, and other vegetation. Often used for "interception loss" or the amount of water evaporated from the precipitation intercepted.

INTERCEPTION CHANNEL -- A channel excavated at the top of earthcuts, at the foot of slopes or at other critical places to intercept surface flow; a catch drain. Syn. Interception Ditch.

INTERCEPTOR DRAIN -- Surface or subsurface drain, or a combination of both, designed and installed to intercept flowing water.

INTERFLOW -- That portion of rainfall that infiltrates into the soil and moves laterally through the upper soil horizons until intercepted by a stream channel or until it returns to the surface at some point downslope from its point of infiltration.

INTERMITTENT STREAM -- A stream or portion of a stream that flows only in direct response to precipitation. It receives little or no water from springs and no long-continued supply from melting snow or other sources. It is dry for a large part of the year, ordinarily more than three months.

INTERNAL SOIL DRAINAGE -- The downward movement of water through the soil profile. The rate of movement is determined by the texture, structure, and other characteristics of the soil profile and underlying layers; and by the height of the watertable, either permanent or perched. Relative terms for expressing internal drainage are: none, very slow, slow, medium, rapid, and very rapid.

LAND -- The total natural and cultural environment within which production takes place; a broader term than soil. In addition to soil, its attributes include other physical conditions, such as mineral deposits, climate, and water supply; location in relation to centers of commerce, populations, and other land; the size of the individual tracts or holdings; and existing plant cover, works of improvement, and the like. Some use the terms loosely in other senses: as defined above but without the economic or cultural criteria; especially in the expression "natural land" as a synonym for "soil"; for the solid surface of the earth; and also for earthy surface formations, especially in the geomorphological expression "land form".

LAND CAPABILITY -- The suitability of land for use without permanent damage. Land capability, as ordinarily used in the United States, is an expression of the effect of physical land conditions, including climate, on the total suitability for use without damage for crops that require regular tillage, for grazing, for woodland, and for wildlife.

Glossary

Land capability involves consideration of (1) the risks of land damage from erosion and other causes and (2) the difficulties in land use owing to physical land characteristics, including climate.

LAND CAPABILITY CLASSIFICATION -- A grouping of kinds of soils into special units, subclasses, and classes according to their capability for intensive use and the treatments required for sustained use. (Prepared by the Soil Conservation Service, USDA.)

LAND CAPABILITY MAP -- A map showing land capability units, subclasses and classes, or a soil survey map colored to show land capability classes.

LAND CAPABILITY UNIT -- Capability units provide more specific and detailed information for application to specific fields on a farm or ranch than the subclass of the land capability classification. A capability unit is a group of soils that are nearly alike in suitability for plant growth and responses to the same kinds of soil management.

LAND CLASSIFICATION -- The arrangement of land units into various categories based on the properties of the land or its suitability for some particular purpose.

LAND-DISTURBING ACTIVITY -- Any land change which may result in soil erosion from water or wind and the movement of sediments into State water or onto lands within the State, including, but not limited to, clearing, dredging, grading, excavating, transporting and filling of land.

LAND FORM -- A discernible natural landscape, such as a floodplain, stream terrace, plateau, valley, etc.

LAND RECLAMATION -- Making land capable of more intensive use by changing its general character, as by drainage of excessively wet land; irrigation of arid or semiarid land; or recovery of submerged land from seas, lakes, and rivers. Large-scale reclamation projects usually are carried out through collective effort. Simple improvements, such as cleaning of stumps or stones from land, should not be referred to as land reclamation.

LEACHING -- The removal from the soil in solution of the more soluble materials by percolating waters.

LEGUME -- A member of the legume or pulse family, *Leguminosae*. One of the most important and widely distributed plant families. The fruit is a "legume" or pod that opens along two sutures when ripe. Flowers are usually papilionaceous (butterflylike). Leaves are alternate, have stipules, and are usually compound. Includes many valuable food and forage species, such as the peas, beans, peanuts, clover, alfalfas, sweet clovers, lespedezas, vetches, and kudzu. Practically all legumes are nitrogen-fixing plants.

LEVEL SPREADER -- A shallow channel excavation at the outlet end of a diversion with a level section for the purpose of diffusing the diversion out-flow.

LIME -- Lime, from the strictly chemical standpoint, refers to only one compound, calcium oxide (CaO); however, the term "lime" is commonly used in agriculture to include a great variety of materials which are usually composed of the oxide, hydroxide, or carbonate of calcium or of calcium and magnesium. The most commonly used forms of agricultural lime are ground limestone (carbonates), hydrated lime (hydroxides), burnt lime (oxides), marl, and oyster shells.

LIME, AGRICULTURAL -- A soil amendment consisting principally of calcium carbonate, but including magnesium carbonate and perhaps other materials, used to furnish calcium and magnesium as essential elements for the growth of plants and to neutralize soil acidity.

LIMING -- The application of lime to land, primarily to reduce soil acidity and supply calcium for plant growth. Dolomitic limestone supplies both calcium and magnesium. May also improve soil structure, organic matter content, and nitrogen content of the soil by encouraging the growth of legumes and soil microorganisms. Liming an acid soil the pH value of about 6.5 is desirable for maintaining a high degree of availability of most of the nutrient elements required by plants.

LIQUEFICATION (spontaneous liquefaction) -- The sudden large decrease of the shearing resistance of a cohesionless soil, caused by a collapse of the structure from shock or other type of strain and associated with a sudden but temporary increase in the pore-fluid pressure. It involves a temporary transformation of the material into a fluid mass.

LIQUID LIMIT (LL) -- The water content corresponding to the arbitrary limit between the liquid and plastic states of consistency of a soil.

LITTER -- In forestry, a surface layer of loose organic debris in forests, consisting of freshly fallen or slightly decomposed organic materials.

LOAMY -- Intermediate in texture and properties between fine-textured and coarse-textured soils.

LOESS -- Material transported and deposited by wind and consisting primarily of silt-sized particles.

LOOSE ROCK DAM -- A dam built of rock without the use of mortar, a rubble dam. See Rock-Fill Dam.

MADE LAND -- Areas filled with earth or earth and trash mixed, usually made by or under the control of man. A miscellaneous land type.

Glossary

MANNING'S FORMULA (hydraulics) -- A formula used to predict the velocity of water flow in an open channel or pipeline:
$$V = \frac{1.49}{n} R^{2/3} S^{1/2}$$

where in **V** is the mean velocity of flow in feet per second, **R** is the hydraulic radius, **S** is the slope of the energy gradient or for assumed uniform flow the slope of the channel in feet per foot, and **n** is the roughness coefficient or retardance factor of the channel lining.

MEAN DEPTH (hydraulics) -- Average depth; cross-sectional area of a stream or channel divided by its surface or top width.

MEAN VELOCITY -- Average velocity obtained by dividing the flow rate discharge by the cross-sectional area for that given cross-section.

MEASURING WEIR -- A shaped notch through which water flows are measured. Common shapes are rectangular, trapezoidal, and triangular.

MECHANICAL ANALYSIS -- The analytical procedure by which soil particles are separated to determine the particle size distribution.

MECHANICAL PRACTICES -- Soil and water conservation practices that primarily change the surface of the land or that store, convey, regulate, or dispose of runoff water without excessive erosion. See Structural Practices.

METAMORPHIC ROCK -- Rock derived from pre-existing rocks but differing from them in physical, chemical, and mineralogical properties as a result of natural geologic processes, principally heat and pressure, originating within the earth. The pre-existing rock may have been igneous, sedimentary, or another form of metamorphic rock.

MONOLITHIC -- Of or pertaining to a structure formed from a single mass of stone.

MOVEABLE DAM -- A moveable barrier that may be opened in whole or in part, permitting control of the flow of water through or over the dam.

MUCK SOIL --

- (1) An organic soil in which the organic matter is well decomposed (USA usage).
- (2) A soil containing 20 to 50 percent organic matter.

MULCH -- A natural or artificial layer of plant residue or other materials, such as sand or paper, on the soil surface.

NATURAL GROUND SURFACE -- The ground surface in its original state before any grading, excavation, or filling.

NOISE POLLUTION -- The persistent intrusion of noise into the environment at a level that may be injurious to human health.

NORMAL DEPTH -- Depth of flow in an open conduit during uniform flow for the given conditions. See Uniform Flow.

OPEN DRAIN -- Natural watercourse or constructed open channel that conveys drainage water.

ORGANIC MATTER -- Any organisms, alive or dead, and any material derived therefrom.

OUTFALL -- Point where water flows from a conduit, stream, or drain.

OUTLET -- Point of water disposal from a stream, river, lake, tidewater, or artificial dam.

OUTLET CHANNEL -- A waterway constructed or altered primarily to carry water from man-made structures, such as terraces, tile lines, and diversions.

OVERFALL -- Abrupt change in stream channel elevation; the part of a dam or weir over which the water flows.

OVERHAUL -- Transportation of excavated material beyond a specified haul limit, usually expressed in cubic yard stations (1 cubic yard hauled 100 feet).

PARENT MATERIAL (soils) -- The unconsolidated, more or less chemically weathered, mineral or organic matter from which the solum of soils has developed by pedogenic processes. The C horizon may or may not consist of materials similar to those from which the A and B horizons developed.

PARGE -- To apply a smooth plaster or sand & cement mixture to masonry walls for waterproofing or esthetics. Also used to fill "honeycombs" or voids in poured concrete.

PEAK DISCHARGE -- The maximum instantaneous flow from a given storm condition at a specific location.

PEDS -- Units of soil structure formed by natural processes.

PEDOLOGICAL AGE -- Maturity of a soil in terms of its developmental characteristics rather than its chronological age.

PERCOLATION -- The downward movement of water through soil, especially the downward flow of water in saturated or nearly saturated soil at hydraulic gradients of the order of 1.0 or less.

PERMEABILITY -- Capacity for transmitting a fluid. It is measured by the rate at which a fluid of standard viscosity can move through material in a given interval of time under a given hydraulic gradient.

Glossary

PERMEABILITY (soil engineering) -- The quality of soil horizon that enables water or air to move through it. The permeability of a soil may be limited by the presence of one nearly impermeable horizon even though the others are permeable.

pH -- A numerical measure of the acidity or hydrogen ion activity. The neutral point is pH 7.0. All pH values below 7.0 are acid and all above are alkaline.

PIPE DROP -- A circular conduit used to convey water down steep grades.

PLASTICITY INDEX (PI) -- The numerical difference between the liquid limit and the plastic limit.

PLASTIC LIMIT (PL) -- The water content corresponding to an arbitrary limit between the plastic and semisolid states of consistency of soil.

PLASTIC SOIL -- A soil capable of being molded or deformed continuously and permanently by relatively moderate pressure.

PLUNGE POOL -- A device used to dissipate the energy of flowing water that may be constructed or made by the action of flowing. These facilities may be protected by various lining materials.

POOLS -- Areas of a stream where the velocity provides a favorable habitat for plankton. Silts and other loose materials that settle to the bottom of pools are favorable for burrowing forms of benthos. Syn. riffle.

PRINCIPAL SPILLWAY -- A water conveying device generally constructed of permanent material and designed to regulate the normal water level, provide flood protection and/or reduce the frequency of operation of the emergency spillway.

RATIONAL FORMULA -- $Q = CIA$. Where **Q** is the peak discharge measured in cubic feet per second, **C** is the runoff coefficient reflecting the ratio of runoff to rainfall, **I** is the rainfall intensity for the duration of the storm measured in inches per hour, and **A** is the area contributing drainage measured in acres.

RELIEF DRAIN -- A drain designed to remove water from the soil in order to lower the watertable and reduce hydrostatic pressure.

RELIEF WELL -- Well, pit, or bore penetrating the water table to relieve hydrostatic pressure by allowing flow from the aquifer.

RESIDUAL SOIL (RESIDUUM) -- Unconsolidated and partly weathered mineral materials accumulated by disintegration of rock in place.

RESTORATION -- The process of restoring site conditions as they were before the land disturbance.

RETENTION -- The practice of capturing and storing runoff for percolation into the ground.

RETURN FLOW -- That portion of the water diverted from a stream that finds its way back to the stream channel either as surface or underground flow.

RILL -- A small intermittent watercourse with steep sides, usually only a few inches deep and thus no obstacle to tillage operations.

RILL EROSION -- See Erosion

RIPRAP -- Broken rock, cobbles, or boulders placed on earth surfaces, such as the face of a dam or the bank of a stream, for protection against the action of water (waves); also applied to brush or pole mattresses, or brush and stone, or other similar materials used for soil erosion control.

RISER -- The inlet portions of drop inlet spillway that extend vertically from the pipe conduit barrel to the water surface.

RIVER BASIN -- A major water resource region. The United States has been divided into 20 river basin areas.

ROCK-FILL DAM -- A dam composed of loose rock usually dumped in place, often with the upstream part constructed of hand placed or derrick-placed rock and faced with rolled earth or with an impervious surface of concrete, timber, or steel.

RUNOFF (hydraulics) -- That portion of the precipitation on a drainage area that is discharged from the area in stream channels. Types include runoff, groundwater runoff, or seepage.

SAND --

- (1) Particle size between 2 mm and 0.05 mm,
- (2) Soil containing more than 84 percent sand.

SCARIFY -- To abrade, scratch, or modify the surface; for example, to scratch the impervious seed coat of hardseed or to break the surface of the soil with a narrow-bladed implement.

SCREENING -- The use of any vegetative planting, fencing, ornamental wall of masonry, or other architectural treatment, earthen embankment, or a combination of any of these which will effectively hide from view any undesirable areas from the main traveled way.

SEDIMENT -- Solid material, both mineral and organic, that is in suspension, is being transported, or has been moved from its site of origin by air, water, gravity, or ice, as a product of erosion.

Glossary

SEDIMENT BASIN -- A depression formed from the construction of a barrier or dam built at a suitable location to retain sediment and debris.

SEDIMENT DISCHARGE -- The quantity of sediment, measured in dry weight or by volume, transported through a stream cross-section in a given time. Sediment discharge consists of both suspended load and bedload.

SEDIMENT LOAD -- See Sediment Discharge.

SEDIMENT POOL -- The reservoir space allotted to the accumulation of submerged sediment during the life of the structure.

SEDIMENTARY ROCK -- Rock formed from materials deposited from suspension or precipitated from solution, usually more or less consolidated.

SEEDBED -- The soil prepared by natural or artificial means to promote the germination of seed and the growth of seedlings.

SEEPAGE --

- (1) Water escaping through or emerging from the ground along an extensive line or surface as contrasted with a spring where the water emerges from a localized spot.
- (2) The slow movement of gravitational water through the soil (percolation).

SHEETFLOW -- Water, usually storm runoff, flowing in a thin layer over the ground surface; also called overland flow.

SHRINK-SWELL POTENTIAL -- Susceptibility to volume change due to loss or gain in moisture content.

SHRINKAGE INDEX (SI) -- The numerical difference between the plastic and shrinkage limits.

SHRINKAGE LIMIT(SL) -- The maximum water content at which a reduction in water content will not cause a decrease in the volume of the soil mass. This defines the arbitrary limit between the solid and semi-solid states.

SILT --

- (1) A soil separate consisting of particles between 0.05 and 0.002 millimeter in equivalent diameter.
- (2) A soil textural class containing more than 80 percent silt and less than 12 percent clay.

SILTING -- See Sediment.

SILT LOAM -- A soil textural class containing a large amount of silt and small quantities of sand and clay.

SILTY CLAY -- A soil textural class containing a relatively large amount of silt and clay and a small amount of sand.

SILTY CLAY LOAM -- A soil textural class containing a relatively large amount of silt, a lesser quantity of clay, and a still smaller quantity of sand.

SLOPE -- The degree of deviation of a surface from horizontal, measured in a numerical ratio, percent, or degrees. Expressed as a ratio or percentage, the first number is the vertical distance (rise) and the second is the horizontal distance (run), as 2:1 or 200 percent. Expressed in degrees, it is the angle of the slope from the horizontal plane with a 90 slope being vertical (maximum) and 45 being a 1:1 slope.

SLOPE CHARACTERISTICS -- Slopes may be characterized as concave (decrease in steepness in lower portion), uniform, or convex (increase in steepness at base). Erosion is strongly affected by shape, ranked in order of increasing erodibility from concave to uniform to convex.

SOIL -- The unconsolidated mineral and organic material on the immediate surface of the earth that serves as a natural medium for the growth of land plants.

SOIL AMENDMENT -- Any material, such as lime, gypsum, sawdust, or synthetic conditioner, that is worked into the soil to make it more amenable to plant growth.

SOIL HORIZON -- A layer of soil or soil material approximately parallel to the surface, occurring naturally, and distinguishable from adjacent horizons by differences in color, texture, quantity of organic matter, etc. Simplified horizon designations are: O = the surface litter, A = topsoil, root zone, B = subsoil, containing more clay and less organic matter than A, C = parent material, and R = bedrock.

SOIL PROFILE -- A vertical section of the soil from the surface through all horizons, including C horizons.

SOIL SERIES -- The basic unit of soil classification, being a subdivision of a family and consisting of soils which are essentially alike in all major profile characteristics except the texture of the A horizon.

SOIL STRUCTURE -- A combination or arrangement of soil particles into larger units, or peds.

SOIL TEXTURE -- The relative proportions of various soil sized particles characterizing a soil, as described by the classes of soil texture shown on the textural triangle.

SPILLWAY -- An open or closed channel, or both, used to convey excess water from a reservoir. It may contain gates, either manually or automatically controlled, to regulate the discharge of excess water.

SPOIL -- Soil or rock material excavated from a canal, ditch, basin, or similar construction.

Glossary

STABILIZATION -- The process of establishing an enduring soil cover of vegetation and/or mulch or other ground cover in combination with installing temporary or permanent structures for the purpose of reducing to a minimum the transport of sediment by wind, water, ice, or gravity.

STABILIZED GRADE -- The slope of a channel at which neither erosion nor deposition occurs.

STAGE (hydraulics) -- The variable water surface or the water surface elevation above any chosen datum. See Gaging Station.

STORM DRAIN OUTLET PROTECTION STRUCTURE -- A device used to dissipate the energy of flowing water. Generally constructed of concrete or rock in the form of a partially depressed or partially submerged vessel and may utilize baffles to dissipate velocities.

STORM FREQUENCY -- An expression or measure of how often a hydrologic event of a given size or magnitude should on an average be, based on a reasonable sample.

STEAMBANKS -- The usual boundaries, not the flood boundaries, of a stream channel. Right and left banks are named facing downstream.

STREAM GAGING -- The quantitative determination of stream flow using gages, current meters, weirs, or other measuring instruments at selected locations. See Gaging Station.

STREAMLOAD -- Quantity of solid and dissolved material carried by a stream. See Sediment Load.

STRUCTURAL PRACTICES -- Soil and water conservation measures, other than vegetation, utilizing the mechanical properties of matter for the purpose of either changing the surface of the land or storing, regulating, or disposing of runoff to prevent excessive sediment loss. Including but not limited to riprap, sediment basins, dikes, level spreaders, waterways or outlets, diversions, grade stabilization structures, sediment traps, land grading, etc. See Mechanical Practices.

SUBSOIL -- The B horizons of soils with distinct profiles. In soils with weak profile development, the subsoil can be defined as the soil below the plowed soil (or its equivalent of surface soil), in which roots normally grow. Although a common term, it cannot be defined accurately. It has been carried over from early days when "soil" was conceived only as the plowed soil and that under it as the "subsoil".

SUBWATERSHED -- A watershed subdivision of unspecified size that forms a convenient natural unit.

TERRACE -- An embankment or combination of an embankment and channel across a slope to control erosion by diverting or storing surface runoff instead of permitting it to flow uninterrupted down from the soil.

TILE, DRAIN -- Pipe made of burned clay, concrete, or similar material, in short lengths, usually laid with open joints to collect and carry excess water from the soil.

TILE DRAINAGE -- Land drainage by means of a series of tile lines laid at a specified depth and grade.

TOE (engineering) -- Terminal edge or edges of a structure; the bottom of a slope.

TOE DRAIN -- Interceptor drain located near the downstream toe of a structure.

TOPSOIL -- Earthy material used as top-dressing for house lots, grounds for large buildings, gardens, road cuts, or similar areas. It has favorable characteristics for production of desired kinds of vegetation or can be made favorable.

TRASH RACK -- A structural device used to prevent debris from entering a spillway or other hydraulic structure.

UNIFIED SOIL CLASSIFICATION SYSTEM (engineering) -- A classification system based on the identification of soils according to their particle size, gradation, plasticity index, and liquid limit.

UNIFORM FLOW -- A state of steady flow when the mean velocity and cross-sectional area are equal at all sections of a reach.

UNIVERSAL SOIL LOSS EQUATION -- An equation used for the design of water erosion control systems: $A = RKLSPC$ wherein **A** = average annual soil loss in tons per acre per year, **R** = rainfall factor, **K** = soil erodibility factor, **L** = length of slope, **S** = percent of slope, **P** = conservation practice factor, and **C** = cropping and management factor.

VEGETATIVE PRACTICE -- Stabilization of erosive or sediment-producing areas by covering the soil with:

- (1) Permanent seeding, producing long-term vegetative cover, or
- (2) Short-term seeding, producing temporary vegetative cover, or
- (3) Sodding, producing areas covered with a turf of perennial sod-forming grass.

WATER CLASSIFICATION -- Separation of water of an area into classes according to usage, such as domestic consumption, fisheries, recreation, industrial, agricultural, navigation, waste disposal, etc.

WATER CONSERVATION -- The physical control, protection, management, and use of water resources in such a way as to maintain crop, grazing, and forest lands; vegetative cover; wildlife; and wildlife habitat for maximum sustained benefits to people, agriculture, industry, commerce, and other segments of the national economy.

WATER CONTROL (soil and water conservation) -- The physical control of water by such measures as conservation practices on the land, channel improvement, and

Glossary

installation of structures for water retardation and sediment detention (does not refer to legislative or regulatory control or water rights).

WATER CUSHION -- Pool of water maintained to absorb the impact of water flowing from an overfall structure.

WATER DEMAND -- Water requirements for a particular purpose, such as irrigation, power, municipal supply, plant transpiration, or storage.

WATER DISPOSAL SYSTEM -- The complete system for removing excess water from land with minimum erosion. For sloping land, it may include a terrace system, terrace outlet channels, dams, and grassed waterways. For level land, it may include only surface drains or both surface and subsurface drains.

WATER QUALITY STANDARDS -- Minimum requirements of purity of water for various uses; for example, water for agricultural use in irrigation systems should not exceed specific levels of sodium bicarbonates, pH, total dissolved salts, etc.

WATER RESOURCES -- The supply of groundwater and surface water in a given area.

WATERCOURSE -- Any natural or artificial watercourse, stream, river, creek, channel, ditch, canal, conduit, culvert, drain, waterway, gully, ravine, or wash in which water flows either continuously or intermittently and which has a definite channel, bed and banks, and including any area adjacent thereto subject to inundation by reason of overflow or floodwater.

WATERSHED AREA -- All land and water within the confines of a drainage divide or a water problem area consisting in whole or in part of land needing drainage or irrigation.

WATERSHED LAG -- Time from center of mass of effective rainfall to peak of hydrograph.

WATERSHED MANAGEMENT -- Use, regulation, and treatment of water and land resources of a watershed to accomplish stated objectives.

WATERSHED PLANNING -- Formulation of a plan to use and treat water and land resources.

WATERWAY -- A natural course or constructed channel for the flow of water. See Grassed Waterway.

WEIR -- Device for measuring or regulating the flow of water.

WEIR NOTCH -- The opening in a weir for the passage of water.

WETTING AGENT -- A chemical that reduces the surface tension of water and enables it to soak into porous material more readily.

Pre-class Quiz

Multiple Choice

1. ____ The four principle factors influencing soil erosion are:
a. Permits, Equipment, Schedule, & People b. Vegetation, Soils, Topography, & Climate
c. Weather, Soils, BMP's, & Maintenance d. Time, BMP's, People, & Soils
2. ____ A detention basin is designed to store stormwater on site and then ____?
a. Release at a controlled rate b. Allow time for percolation
c. Allow time for evaporation d. Filter the water
3. ____ For proper installation of a silt fence, a trench ____ inches deep and ____ inches wide must be excavated. This will allow the ____ inches of fabric to be buried.
a. 2"D x 2"W; 4" b. 6"D x 4"W; 8" c. 4"D x 6"W; 8" d. 4"D x 4"W; 8"
4. ____ The initial storage capacity of traps and basins is ____ cu. yd. or ____ cu. ft. per acre.
a. 67 yd³ / 1800 ft³ b. 134 yd³ / 3600 ft³
c. 100 yd³ / 2700 ft³ d. 50 yd³ / 1350 ft³
5. ____ In flowing water, turbidity curtains should be placed ____ to the direction of flow.
a. Perpendicular b. Diagonal c. Parallel d. Not at all
6. ____ Which portion of the plan gives exact information on the type of BMP installation procedures, materials, special considerations, etc.?
a. Narrative b. Details & specifications c. Site plan d. Calculations
7. ____ By definition a swale should have side slopes no steeper than ____.
a. 1:1 b. 2: 1 c. 3:1 d. 4:1 e. 5:1
8. ____ What parts of a stormwater pond are most likely to fail due to improper compaction?
a. Structural elements b. Aquatic plants c. Ornamental plants
d. Burrowing animals e. Insects & bugs
9. ____ BMP maintenance activities can be classified into categories including ____?
a. aesthetic b. preventative c. corrective d. all of the above
10. ____ Signs that an infiltration practice is clogging and needs maintenance include:
a. standing water b. soggy soils c. wetland plants d. all of the above
11. ____ At the pre-construction conference, be sure that all parties posses and understand a copy of ____?
a. The approved plan b. The Inspectors Manual
c. The Articles of Incorporation d. The Racing Form
12. ____ The littoral zone of a wet detention system should cover at least ____% of its surface area.
a. 10 b. 20 c. 30 d. 40 e. 50

Post-class Quiz

Fill in the blanks

1. A detention basin is designed to store stormwater on site and then _____.
2. The initial storage capacity of traps and basins is _____ cu. yd. or _____ cu. ft. per acre.
3. The four principle factors influencing soil erosion are _____
_____.
4. Which portion of the plan gives exact information on the type of BMP installation procedures, materials, special considerations, etc.? _____.
5. For proper installation of a silt fence, a trench _____ inches deep and _____ inches wide must be excavated. This will allow the _____ inches of fabric to be buried.
6. By definition a swale should have side slopes no steeper than _____:_____.
7. At the pre-construction conference, be sure that all parties posses and understand a copy of _____.
8. What parts of a stormwater pond are most likely to fail due to improper compaction? _____.
9. In flowing water, turbidity curtains should be placed _____ to the direction of flow.
10. BMP maintenance activities can be classified into categories including _____.
11. The littoral zone of a wet detention system should cover at least _____% of its surface area.
12. Signs that an infiltration practice is clogging and needs maintenance include: _____.

**Florida Stormwater, Erosion, & Sedimentation Control
Training and Certification Program**

PROGRAM EVALUATION

Instructor(s): _____

Class Location: _____

Date: _____

Please rate each of the following areas by checking the appropriate number:
1 Poor, 2 Fair, 3 Good, 4 Great. Comment where appropriate.

Announcement & Registration

1 2 3 4

Comment

The Manual

1 2 3 4

Comment

The Multi-media Presentation

1 2 3 4

Comment

The Review Workbook

1 2 3 4

Comment

**Florida Stormwater, Erosion, & Sedimentation Control
Training and Certification Program**

PROGRAM EVALUATION

Please rate each of the following areas by checking the appropriate number:
1 Poor, 2 Fair, 3 Good, 4 Great. Comment where appropriate.

The Facility

1 2 3 4

Comment

The Instructor(s)

1 2 3 4

Comment

The Overall Program

1 2 3 4

Comment

The Future

Please answer "Yes" or "No" for these survey questions:

Would you like to have a Florida Stormwater & Erosion Control Annual Conference?

Potential topics are: advanced erosion control applications, case histories, dewatering, polyacrylamide applications, new technology, and agency regulatory updates.

Yes No

Additional Comments